



2024 / 2025

Original Equipment for the aftermarket

Spiegelsysteme für Nutzfahrzeuge
Mirror systems for commercial vehicles

I - II - III - IV - V - VI
Spiegelklasse
mirror class

Material des Spiegelgehäuses
material of the mirror body

Durchmesser der Spiegelstange
oder Art der Montage
diameter of the mirror bracket
or way of mounting

Fahrzeugtyp / Baujahr
vehicle model / year of production

EG-Prüf-Nummer
CE-number



2013/97/EG
01/07
01/07 - 11/14
01/07 - 11/14

Spiegeltyp
mirror type

392-1	II e1 03★0024	II e1 02 0925	Truck II	ABS	Ø 28 mm		
51.3921.224H					399 x 207 x 137	81.63730-6482	
51.3923.224H					339 x 222 x 138	81.63730-6487	
51.3921.223H					399 x 207 x 137	81.63730-6480	
51.3923.223D					399 x 222 x 138	81.63730-6485	
15.3920.840H					379 x 166 x 47	81.63733-6049	
51.3922.224H					399 x 222 x 138	81.63730-6483	
51.3924.224H					399 x 207 x 137	81.63730-6486	
51.3922.223H					399 x 222 x 138	81.63730-6481	
51.3924.223D							
51.3922.233H							
15.3920.840H							
11.3921.0000							

New Regulation
TGA
TGL
TGM

Beschreibung des Artikels
description of the item

Abmessungen
dimensions

Originalnummer des Fahrzeugherstellers
OE number of the vehicle manufacturer

MEKRA Artikel-Nummer

- grüner Hintergrund Komplettsystem
- grauer Hintergrund Zubehör, im Lieferumfang des Komplettsystems
- gelber Hintergrund Zubehör, gesondert zu bestellen

MEKRA article number

- green background complete system
- grey background accessory, included in delivery of the complete system
- yellow background accessory, must be ordered separately





Inhalt index

Aufbau der MEKRA Artikelnummern

Structure of the MEKRA article numbers 04

Verzeichnis der Spiegel-Typen

Mirror type list 05

Liste aller MEKRA Artikel im Katalog

List of all MEKRA-articles in this catalogue 06-07

Homologationsnummernliste

List of homologation numbers 08-09

Vergleichsliste nach OE - Nummern

Cross-reference-table 10-17

Fahrzeughersteller

Manufacturer 18-79

DAF 18-23

IVECO 24-25

MAN 26-43

MERCEDES 44-57

RENAULT 58-60

SCANIA 61

VOLVO 62-65

VOLKSWAGEN (VW) 66-69

UNIVERSAL 70-83

Allgemeine Verkaufs- und Lieferbedingungen

General terms and conditions of sale and delivery 84-85

9 stellig digit

04...	
08...	
09...	
10...	
11...	
13...	
14...	
15...	
20...	
39...	
40...	
51...	
53...	
55...	
56...	
58...	
59...	
61...	

3. - 5. Ziffer digit = Spiegeltyp mirror type

12 stellig digit

08...	
09...	
11...	
12...	
14...	
15...	
19...	
20...	
40...	
51...	
55...	
56...	
58...	
59...	
61...	

3. - 6. Ziffer digit = Spiegeltyp mirror type

z. B. / e. g. 59.5800.101H = Typ / type 580

59.2910.001.001 = Typ / type 291

59.1018.003.099 = Typ / type 1018



152 ASKB	72
224	64
248/2 A	81
249 K	53
249 L	53
250	62
251	28
252	62
253	44
254	44
260	26
265	27
266	27
266-1	27
270 A	83
271	40,77
271 A	81
276	40
277	42
278	41
279	25
281	52
289	72
291	78,79
300	71
320	26
340	26
341	26
348	19,60
349	53,65
349 TW	53,65
360	62
360-1	62
363	72
364	28
365-1	27
370	62
371	62
373	18,3
375	45
375 A	45
377	45,48



377-1	45,48
378	48
378 A	48
378-1	48
380-1	31
381-1	31
385	70
386	18,3
386-1	18
389	71
390	58,59,63
392	32
392-1	33
392-2	34
393	32
393-1	33
393-2	34
395	52
396	47,49
398	52
400	61
552	21
552-1	21,59,63,68,69
558	60
559	20,23
570	20
570 A	21
571	20
572	29,62
573	29,62
574	20
575	46
575 A	46
577	46
579	29,34,35,47,49
580	35
589	54,55,66,67
600	50
750	69
906	18,23
1000	65
1004	47,49,50



1005	21,23,61
1008	24,25
1009	73
1010	74
1012	50
1013	38,39,68,69
1016	82
1017	74
1018	76
1019	61
1020	37,61
1024	36
1025	21,60,64
1027	22
1036	75
1033	58
1038	74
1039	56,57
1041	43
1042	43
1043/1044	65



04.0603.007.000	32,33,34	11.3931.110H	33	15.3811.870H	31	19.5770.311.099	46	51.1009.045.001	73
08.1024.124.099	43,61,80	11.3931.120H	33	15.3861.114H	18	19.5890.011.099	55,57,67	51.1009.047.001	73
08.1039.001.099	56	11.5700.100H	20	15.3862.174H	18	19.5890.012.099	55,57,67	51.1009.049.099	73
08.1039.002.099	56	11.5710.110H	20	15.3900.840H	58,59,63	19.5891.011.099	55,67	51.1009.081.099	73
08.1039.005.099	56	11.5721.001.099	29,64	15.3910.871H	59	19.5891.012.099	55,67	51.1009.097.099	73
08.1039.006.099	56	11.5731.001.099	29,64	15.3910.872H	59	20.1016.004.000	82	51.1009.113.099	73
08.1039.011.099	56	11.5800.100H	35	15.3911.871H	58,63	20.1042.002.099	43	51.1009.121.099	73
08.2770.001.000	42	11.5800.200H	35	15.3911.872H	58,63	20.1042.003.099	43	51.1009.122.099	73
08.2910.001.002	42,79	11.9060.100H	18,23	15.3920.840H	33	20.2480.210H	81	51.1009.149.099	73
08.3200.233H	41,42,76,79,80	12.1005.001.099	23	15.3921.870H	32	20.2480.211H	81	51.1009.242.099	73
08.3950.001.099	42,79	12.1018.001.099	76	15.3922.870H	32	20.2480.213	77,81	51.1010.010.001	74
08.5380.004.000	64	12.1018.002.099	76	15.3932.870H	33	20.2480.216H	40,52,77,81	51.1036.007.099	75
08.5752.012	41	12.1018.003.099	76	15.3946.670F	27	20.2480.217H	40,52,77,81	51.1036.008.099	75
08.5752.024.099	41,42,58,59,63	12.1018.005.099	76	15.3951.114	52	20.2480.223	81	51.1036.009.099	75
	80	12.1018.007.099	76	15.3951.174	52	20.2700.200H	40,77	51.1036.010.099	75
08.5890.300.099	55,67	12.1018.009.001	76	15.3961.174H	47,49	20.2710.111H	77	51.1036.021.099	75
08.5890.301.099	55,67	12.1018.010.001	76	15.4001.740H	61	20.2710.121	77	51.1036.022.099	75
08.5892.001.099	55,67	12.1020.003.099	37,61	15.4001.840H	61	20.2710.200H	40,77	51.1036.023.099	75
08.5892.002.099	55,57,67	12.1024.009.099	36	15.5701.840H	20	20.2710.620	40,41,81	51.1036.024.099	75
08.5892.003.099	55,57,67	12.1024.010.099	36	15.5711.870H	20	20.2710.650	41	51.1036.025.099	75
08.5892.004.099	55,67	12.1024.011.099	36	15.5750.840H	46	20.3750.710.099	45	51.1036.026.099	75
08.5892.105.099	55,57,67	12.1024.012.099	36	15.5770.870H	46	20.3750.720.099	45	51.1038.003.099	74
09.1000.200.099	65	12.1027.001.099	22	15.5791.470H	29,32,47,49	20.3780.700H	48	51.1038.004.099	74
09.1041.002.099	43	12.1027.002.099	22	15.5791.570.099	29,32,34,35	20.3900.510H	58,59,63	51.1043.001.099	65
09.1041.004.099	43	12.1027.005.099	22	15.5801.840H	35	20.3900.520H	58,59,63	51.1043.002.099	65
09.2000.301H	26,27,70,73,80	12.1027.006.099	22	15.5811.871H	35	20.5521.100H	20	51.1044.001.099	65
09.2070.101H	26,28,44,62,80	12.1027.015.099	22	15.5811.872H	35	20.5700.410H	21	51.1044.002.099	65
09.2770.001.000	42,79	12.1027.016.099	22	15.5891.611H	55,67	20.5700.420H	21	51.1524.119H	72
09.2770.210	42	12.1027.103.099	22	15.5891.612H	55,67	20.5750.710.099	46	51.2491.121H	53
09.2770.211	42	12.1027.104.099	22	15.5891.721.099	55,57,67	20.5750.720.099	46	51.2491.122H	53
09.2910.002.099	76,79	12.1027.107.099	22	15.5891.722.099	55,57,67	20.5800.410H	35	51.2493.121H	53
09.2910.003.099	42,79	12.1027.108.099	22	15.5891.741H	55,67	20.5800.420H	35	51.2493.127H	53
09.2910.004.099	79	12.1027.203.099	22	15.5891.742H	55,67	20.5800.610H	35	51.2500.127H	62
09.2910.005.099	76,79	12.1027.204.099	22	15.6000.001.099	50	20.5800.620H	35	51.2500.147H	62
09.2910.007.000	79	12.1027.207.099	22	15.6000.002.099	50	20.5800.710H	35	51.2510.127H	28
09.3200.220	80	12.1027.208.099	22	15.6000.003.099	50	20.5800.720H	35	51.2510.137H	28
09.3200.320H	80	12.1041.001.099	43	15.6000.004.099	50	20.5800.750H	35	51.2510.147H	28
09.3200.420H	26,73,75,80	12.1041.002.099	43	15.9060.870H	18	20.7504.003.001	71	51.2520.127H	62
09.3300.421	80	12.1041.003.099	43	19.1000.101.099	65	20.7504.044.001	71	51.2520.147H	62
09.3400.420	26,70,80	12.1041.004.099	43	19.1000.102.099	65	40.1009.001.000	73	51.2530.120H	44
09.3900.003.000	58,59,63	12.1041.005.099	43	19.1000.103.099	65	40.1009.001.099	73	51.2530.140H	44
09.5700.001.099	20	12.1042.001.099	43	19.1000.121.099	65	40.1009.002.000	73	51.2540.120H	44
09.5700.002.099	20	12.1042.002.099	43	19.1000.122.099	65	40.1009.002.099	73	51.2540.130H	44
09.5750.001.099	46	12.3920.001.099	34	19.1008.041.099	24	40.1009.003.099	73	51.2540.140H	44
09.5750.220.099	46	12.3920.002.099	34	19.1008.311.099	24	40.1009.004.099	73	51.2890.117H	72
10.6111.100	28	12.3930.001.099	34	19.1012.000.099	50	40.1009.005.099	73	51.2890.147H	72
10.6121.100	26,28	12.3930.002.099	34	19.1012.001.099	50	40.1009.421.002	73	51.3000.001.001	71
10.6211.100	28,70	12.5590.009.099	23	19.1012.002.099	50	40.1009.422.002	73	51.3000.002.001	71
10.6221.100	28,70,72	12.5700.001.099	21	19.1012.003.099	50	40.1010.002.099	74	51.3200.147H	26
10.6321.100	26,27	12.5700.002.099	21	19.1013.011.099	39,69	40.1038.411.099	74	51.3400.147H	26
11.1008.001.099	24	12.5700.003.099	21	19.1013.012.099	39,69	40.1038.412.099	74	51.3410.127H	26
11.1036.011.099	75	12.5700.004.099	21	19.1018.311.099	76	40.1038.751.099	74	51.3410.140	26
11.1036.012.099	75	12.5740.002.099	20	19.1018.312.099	76	40.1038.752.099	74	51.3410.147H	26
11.1036.013.099	75	13.1024.001.099	36	19.1019.013.099	61	40.1525.114H	72	51.3412.120H	26
11.1036.014.099	75	13.1024.002.099	36	19.1019.014.099	61	40.2500.222H	62	51.3490.110H	53
11.1039.001.099	56	13.1024.003.099	36	19.1019.313.099	61	40.2500.422H	62	51.3490.112H	53
11.1039.002.099	56	13.1024.004.099	36	19.1019.314.099	61	40.2510.222H	28	51.3490.120H	53
11.1039.011.099	56	13.1039.001.099	56	19.1020.213.099	37,61	40.2510.322H	28	51.3490.122H	53
11.1039.012.099	56	13.1039.002.099	56	19.1020.613.099	37,61	40.2510.422H	28	51.3495.112H	65
11.2770.102	42	13.1043.001.000	65	19.1024.011.099	36	40.2520.222H	62	51.3495.122H	65
11.2770.202	42	13.1044.001.000	65	19.1024.012.099	36	40.2520.422H	62	51.3635.201	72
11.2770.302	42	13.5800.100H	35	19.1024.311.099	36	40.2530.222H	44	51.3635.204	72
11.2770.402	42	13.5890.110.199	55,57,67	19.1024.312.099	36	40.2530.422H	44	51.3635.206	72
11.2770.920	42	13.5890.120.099	55,57,67	19.1027.011.099	22	40.2540.222H	44	51.3636.201	72
11.2780.910	41	13.5890.210.199	55,57,67	19.1027.012.099	22	40.2540.422H	44	51.3636.204	72
11.2780.920	41	13.5890.220.099	55,57,67	19.1027.311.099	22	40.2605.204H	26	51.3636.206	72
11.2790.001.099	25	14.5890.100.099	55,57,67	19.1027.312.099	22	40.2660.404H	27	51.3640.127H	28
11.2790.002.099	25	14.5890.200.099	55,57,67	19.1033.001.199	58	40.2665.203H	27	51.3640.137H	28
11.2810.200H	52	15.2240.840H	64	19.1033.002.199	58	40.2665.204H	27	51.3640.147H	28
11.2910.001.000	79	15.2711.114	40,77	19.1036.005.099	75	40.2665.403H	27	51.3731.325	30
11.2910.002.000	79	15.2711.214H	53,65	19.1036.006.099	75	40.2890.222H	70,72	51.3731.326	40,77
11.2910.003.000	79	15.2712.113F	77	19.1036.007.099	75	40.2890.322	70	51.3732.325	30
11.2910.004.000	79	15.2712.114	40,77	19.1036.008.099	75	40.2890.422H	70,72	51.3732.326	40,77
11.2910.006.000	79	15.2771.840	42	19.1036.009.099	75	40.3200.422H	26	51.3735.121H	30
11.2910.007.000	79	15.2771.870	42	19.1036.010.099	75	40.3485.403H	19,60	51.3735.124H	30
11.2910.008.000	79	15.2780.840	41,43,79	19.1039.011.099	56	40.3485.412H	19,60	51.3735.126H	30
11.2910.009.000	79	15.2780.841F	41,76,79	19.1039.012.099	56	40.3605.203H	62	51.3736.121H	30
11.2910.011.002	79	15.2780.870	41	19.1039.311.099	56	40.3605.204F	62	51.3736.124H	30
11.2910.012.002	79	15.2780.871F	41	19.1039.312.099	56	40.3605.403H	62	51.3736.126H	30
11.3480.100	19,60	15.2810.480H	52	19.1039.411.099	56	40.3640.222H	26,28	51.3801.148H	31
11.3730.210H	18,40,72,77	15.3480.840H	19,60	19.1039.412.099	56	40.3640.322H	28	51.3801.168H	31
11.3730.310H	30	15.3491.071H	53,65	19.1039.811.099	56	40.3640.422H	26,28	51.3802.148H	31
11.3800.300H	31	15.3491.072H	53,65	19.1039.812.099	56	40.5725.212H	29	51.3802.168H	31
11.3810.340	31	15.3491.371H	53,65	19.1043.001.099	65	40.5725.412H	29,64	51.3850.127H	70
11.3860.300H	30	15.3491.372H	53,65	19.1044.001.099	65	40.5735.203H	29	51.3850.137	70
11.3860.500H	18	15.3702.470H	62	19.2790.011.099	25	40.5735.403H	29,64	51.3850.147H	70
11.3860.700	29,30,31	15.3731.070H	30	19.2790.012.099	25	51.1009.			



51.3920.003.099	34	56.3812.148H	31	59.1013.309.199	38,68	59.2770.310.099	42	59.5800.422H	35
51.3920.004.099	34	56.3812.168H	31	59.1013.316.199	38,68	59.2771.210.099	42	61.1009.001.099	73
51.3920.005.099	34	56.3860.112H	30	59.1013.317.199	38,68	59.2780.120.099	41	61.1009.002.099	73
51.3920.012.099	34	56.3860.114H	30	59.1013.401.199	38,68	59.2780.140.001	41	61.1000.004.099	65
51.3920.013.099	34	56.3861.116H	30	59.1013.412.199	38,68	59.2780.150.001	41	61.1024.224.099	22
51.3920.014.099	34	56.3862.116H	30	59.1013.416.199	38,68	59.2780.170.001	41	61.1029.224.099	22
51.3921.222H	32	56.3930.001.099	34	59.1013.501.199	38,68	59.2780.180.001	41	61.1039.002.099	56
51.3921.223H	33	56.3930.002.099	34	59.1013.509.199	38,68	59.2780.200.001	41	61.1042.005.099	43
51.3921.224H	33	56.3930.003.099	34	59.1013.601.199	38,68	59.2781.120	41	61.1042.006.099	43
51.3922.222H	32	56.3930.004.099	34	59.1013.612.199	38,68	59.2810.111H	52	61.2530.110H	44
51.3922.223H	33	56.3931.323H	33	59.1018.001.099	76	59.2810.113H	52	61.2703.110	83
51.3922.224H	33	56.3931.343H	33	59.1018.002.099	76	59.2910.001.001	78	61.2703.120	83
51.3923.223D	33	56.3932.323H	33	59.1018.003.099	76	59.2910.002.001	78	61.2708.842H	83
51.3923.224H	33	56.3932.343H	33	59.1018.004.099	76	59.2910.003.001	78	61.2770.210	42
51.3924.223D	33	56.3960.148H	47,49	59.1018.007.099	76	59.2910.004.001	78	61.2770.211	42
51.3924.224H	33	56.5730.120H	29	59.1018.008.099	76	59.2910.005.001	78	61.2770.900.099	42
51.5524.930H	59,63,71	56.5730.140H	29	59.1024.001.099	36	59.2910.006.001	78	61.2770.901.099	42
51.5720.120H	29	56.5790.002.099	34,35	59.1024.002.099	36	59.2910.007.001	78	61.2772.100	42
51.5720.140H	29	56.5790.003.099	29,32	59.1024.005.099	36	59.2910.008.001	78	61.2772.211.099	42
51.5721.160H	29	56.5790.004.099	29,32,47,49	59.1024.006.099	36	59.2910.009.001	78	61.2910.001.001	79
51.5722.160H	29	56.9065.110	18	59.1024.009.099	36	59.2910.010.001	78	61.2910.002.001	79
51.5750.001.099	46	58.1016.001.099	82	59.1024.010.099	36	59.2910.012.001	78	61.2910.003.001	79
51.5750.002.099	46	58.1016.002.099	82	59.1024.013.099	36	59.2910.013.001	78	61.2910.004.001	79
51.5750.003.099	46	58.1016.003.099	82	59.1024.014.099	36	59.2910.014.001	78	61.2910.005.001	79
51.5750.004.099	46	58.1016.004.099	82	59.1024.017.099	36	59.2910.015.001	78	61.2910.006.001	79
51.5770.001.099	46	58.1016.005.099	82	59.1024.019.099	36	59.2910.016.001	78	61.2910.007.001	79
51.5891.111.199	54,66	58.1016.006.099	82	59.1024.021.099	36	59.2910.017.001	78	61.2910.008.001	79
51.5891.112.199	54,66	58.1017.005.099	74	59.1024.022.099	36	59.2910.018.001	78	61.2910.021.001	79
51.5891.113.199	54,66	58.1017.006.099	74	59.1024.023.099	36	59.2910.019.001	78	61.2910.022.001	79
51.5891.114.199	54,66	58.1017.011.099	74	59.1024.024.099	36	59.2910.020.001	78	61.3000.003.010	71
51.5891.211.199	54,66	58.1017.012.099	74	59.1024.025.099	36	59.3491.110H	53	61.3000.004.010	71
51.5891.212.199	54,66	58.1017.013.099	74	59.1024.026.099	36	59.3491.120H	53	61.3480.149H	19,60
51.5891.213.199	54,66	58.1017.014.099	74	59.1024.027.099	36	59.3492.110H	53	61.3481.149H	19,60
51.5891.214.199	54,66	58.1017.015.099	74	59.1024.028.099	36	59.3492.120H	53	61.3482.149H	19,60
51.5891.311.199	54,66	58.1017.016.099	74	59.1024.029.099	36	59.3601.128H	62	61.3730.324H	18
51.5891.312.199	54,66	58.1038.003.099	74	59.1024.030.099	36	59.3601.178H	62	61.3730.326H	18
51.5891.313.199	54,66	58.1038.004.099	74	59.1025.001.099	21,60,64	59.3601.188H	62	61.3752.147H	45,52
51.5891.314.199	54,66	58.2704.044	83	59.1025.002.099	21,60,64	59.3602.128H	62	61.3752.167H	45,52
51.5891.411.199	54,66	58.2704.048	83	59.1027.001.099	22	59.3652.128H	27	61.3770.147H	45,48
51.5891.412.199	54,66	58.2704.051H	83	59.1027.002.099	22	59.3652.148H	27	61.3772.147H	45,48
51.5891.413.199	54,66	58.2704.070	83	59.1027.003.099	22	59.3652.168H	27	61.3773.147H	45,48,52
51.5891.414.199	54,66	58.2704.086	83	59.1027.004.099	22	59.3891.140H	71	61.3780.100H	45,47,48,49,52
51.5892.111.199	54,66	58.2704.088	83	59.1039.101.099	56	59.3900.123H	59	61.3780.147H	48
51.5892.112.199	54,66	58.2704.093	83	59.1039.104.099	56	59.3900.133H	58,63	61.3782.147H	48
51.5892.113.199	54,66	58.2705.001H	83	59.1039.105.099	56	59.3900.143H	58,63	61.3782.167H	48
51.5892.211.199	54,66	58.2705.003	83	59.1039.125.099	56	59.3900.223H	59	61.3783.147H	48
51.5892.212.199	54,66	58.3752.100	45	59.1039.151.099	56	59.3900.233H	58,63	61.3783.167H	48
51.5892.213.199	54,66	58.3752.200	45	59.1039.154.099	56	59.3900.243H	58,63	61.3860.100	18
51.5892.311.199	54,66	58.3781.100H	48	59.1039.155.099	56	59.3900.333	58,63	61.3860.214H	18
51.5892.312.199	54,66	58.3781.200H	48	59.1039.158.099	56	59.3900.343	58,63	61.3865.124H	18
51.5892.313.199	54,66	58.3783.200H	48	59.1039.175.099	56	59.3900.433	58,63	61.3900.100H	58,59,63
51.5892.411.199	54,66	58.3783.300H	48	59.1039.201.099	56	59.3900.443	58,63	61.3900.110H	58,59,63
51.5892.413.199	54,66	58.5700.001.099	21	59.1039.204.099	56	59.3962.210H	47	61.3900.120H	58,59,63
51.5893.111.199	54,66	58.5700.003.002	21	59.1039.205.099	56	59.3962.210H	47	61.3900.130H	58,59,63
51.5893.112.199	54,66	58.5700.004.002	21	59.1039.225.099	56	59.3965.210H	49	61.3910.110H	59
51.5893.113.199	54,66	58.5701.104.099	21	59.1039.251.099	56	59.3980.011H	52	61.3910.120H	59
51.5893.211.199	54,66	58.5710.001.099	21	59.1039.254.099	56	59.3980.012	52	61.3911.110H	58,63
51.5893.212.199	54,66	58.5713.114.099	21	59.1039.255.099	56	59.3980.021H	52	61.3911.120H	58,63
51.5893.213.199	54,66	58.5750.005.199	46	59.1039.258.099	56	59.3980.022H	52	61.5590.001.099	20,79
51.5894.112.199	54,66	58.5750.012.199	46	59.1039.275.099	56	59.3980.111	52	61.5700.210H	20
51.5894.212.199	54,66	58.5752.100H	46	59.1039.501.099	57	59.3980.112	52	61.5700.310.099	20
51.5894.310.199	54,66	58.5752.200H	46	59.1039.525.099	57	59.3980.121	52	61.5710.210H	20
51.5894.410.199	54,66	58.5752.300H	46	59.1039.551.099	57	59.3980.122	52	61.5710.310.099	20
51.5895.312.199	54,66	58.5752.400E	46	59.1039.558.099	57	59.3980.132	52	61.5721.004.099	29,64
51.5895.412.199	54,66	58.5800.101H	35	59.1039.575.099	57	59.3980.141	52	61.5721.005.099	64
51.7504.044.001	71	58.5800.102H	35	59.1039.601.099	57	59.3980.142	52	61.5721.006.099	64
55.1008.002.099	25	58.5800.201H	35	59.1039.625.099	57	59.5520.130H	21	61.5731.001.099	64
55.1008.003.099	25	58.5800.202H	35	59.1039.651.099	57	59.5520.230H	21	61.5740.001.099	20
55.1008.004.099	25	59.1005.001.099	21	59.1039.658.099	57	59.5520.530H	70	61.5750.100H	46
55.3000.001.001	71	59.1005.002.099	21	59.1039.675.099	57	59.5524.530H	71	61.9065.114H	18
55.3000.002.001	71	59.1005.003.099	61	59.1039.701.099	57	59.5524.648.099	59,63		
55.3000.003.001	71	59.1005.011.099	23	59.1039.751.099	57	59.5524.649.099	59		
55.3000.004.001	71	59.1008.005.099	24	59.1039.801.099	57	59.5580.147H	60		
56.1004.001.099	47,49,50	59.1008.006.099	24	59.1039.851.099	57	59.5580.247H	60,63		
56.1008.002.099	24	59.1008.011.099	24	59.1041.001.099	43	59.5590.013.099	23		
56.1008.003.099	24	59.1008.012.099	24	59.1041.002.099	43	59.5590.014.099	23		
56.1008.004.099	24	59.1008.017.099	24	59.1041.003.099	43	59.5595.131H	20		
56.1020.015.099	37	59.1008.018.099	24	59.1041.004.001	43	59.5595.132H	20		
56.1020.017.099	37	59.1008.045H	24	59.1042.001.099	43	59.5595.235H	20		
56.1020.018.099	37	59.1008.046H	24	59.1042.002.099	43	59.5595.236	20		
56.1020.019.099	37	59.1008.051H	24	59.1042.003.099	43	59.5595.331H	20		
56.1020.020.099	37,61	59.1008.052H	24	59.1042.004.099	43	59.5595.332	20		
56.2600.127H	26	59.1008.057H	24	59.1042.005.099	43	59.5800.101H	35		
56.2600.147H	26	59.1008.058H	24	59.2652.110H	27	59.5800.102H	35		
56.2650.121H	27	59.1013.101.199	38,68	59.2710.401H	77	59.5800.121H	35		
56.2660.001.099	27	59.1013.102.199	38,68	59.2710.402H	77	59.5800.122H	35		
56.2660.002.099	27	59.1013.106.199	38,68	59.2710.406	77	59.5800.201H	35		
56.2660.004.099	27	59.1013.109.199	38,68	59.2710.454	77	59.5800.202H	35		
56.2660.127H	27	59.1013.116.199	38,68	59.2712.111	40	59.5800.203H	35		

Homologationsnummern List of homologation numbers

e	E	Typ	type	Тип	тип
		tipo	тип	Тип	тип
II	e1	03*0002	575	46	
IV	e1	03*0003	577	46	
V	e5	02*0003	156/6 BO	--	
IV	e11	03*0003	224	64	
IV	E11	02*0003	224	64	
V	e5	02*0004	156/6 BO	--	
V	e11	03*0004	224	64	
VI	e11	03*0005	224	64	
VI	E11	02*0005	224	64	
IIIII	e1	03*0006	589	54,55,66,67	
III	e1	03*0007	570	20	
IV	e1	03*0008	571	20	
II	e1	03*0009	390	58,59,63	
IV	e1	03*0010	390	58,59,63	
V	e1	03*0011	558	60,61,63	
V	e1	02*0013	379-1	--	
IV	e1	03*0014	906	18	
VVI	e1	03*0015	365-1	27	
394, 394-1					
VI	e1	03*0016	389	71	
VI	e1	03*0017	396	47,49	
II	e1	03*0018	378-1	48	
IV	e1	02*0019	377-1	45,48	
II	e1	03*0022	271	40,77	
271-K					
276					
363					
373					
380-1					
IV	e1	03*0023	386, 386-1	--	
381-1					
II	e1	03*0024	392-1	33	
II	e1	03*0024	392-2	34	
IV	e1	03*0025	393-1	33	
IV	e1	03*0025	393-2	34	
II	e1	03*0031	572	29,64	
IV	e1	03*0032	573	29,64	
V+VI	e1	03*0033	552-1	21,59,63,70,71	
IV	e1	03*0037	390	58,59,63	
V	e1	02*0039	360-1	62	
VI	e1	03*0042	287-1 / 288-1	--	
V	e1	03*0044	287-1 / 288-1	--	
II	e1	03*0047	273	--	
395					
II	e1	03*0048	340	26	
II	e11	03*0050	400	61	
II	E11	02*0050	400	61	
IV	e11	03*0051	400	61	
IV	E11	02*0051	400	61	
II	e1	03*0060	364-1	--	
II	E1	01*00620	273	--	
395					
II	e1	03*0082	274	--	
II	e1	03*0084	277	42	
II	e1	03*0088	271	40,77	
271-K					
276					
363					
373					
380-1					
II	e1	03*0097	580	35	
IV	e1	03*0098	580	35	
V	e1	03*0109	579		
29,32,34,35,47,49					
II	e1	03*0115	380-1	31	
II	e1	03*0123	375	45	
398					
II	e1	03*0124	281	52	
II	e1	03*0128	278	41	
IV	e1	03*0129	278	41	
V	e1	03*0174	395	52	
II	e1	03*0184	348	19,60	
V	e1	03*0185	348	19,60	
II	e1	03*0188	374-1	--	
IV	E5	01*019	156/6 BO	--	
VI	e1	03*0196	559	21,23	
V	E5	01*020	156/6 BO	--	
IV	e1	03*0234	371-1	--	
II	e1	03*0242	1000-1	--	
IV	e1	03*0243	1000-2	--	
V	e1	03*0244	1001	--	
VI	e1	03*0245	1002	--	
II	e1	03*0257	385-1	--	
II	E1	01*0376	258	--	
II	E1	01*0377	258	--	
II	e1	02*0382	385	70	
II	e1	02*0384	349	53,65	
II	E1	01*0384	349	53,65	
II	e1	01*0391	282	--	
II	e1	01*0392	283	--	
IV	E1	01*0392	283	--	
IV	e1	01*0394	367	--	
IV	E1	01*0394	367	--	
II	e1	01*0395	368	--	
II	e1	02*0418	349	53,65	
II	e1	01*0423	271	40,77	
276					

e	E	Typ	type	Тип	тип
		tipo	тип	Тип	тип
363					
72					
373					
18,30					
380-1					
31					
II	E1	01*0423	271	40,77	
276					
40					
363					
72					
373					
18,30					
380-1					
31					
IV	e1	02*0424	386, 386-1	--	
381, 386-1					
IV	E1	01*0424	386, 386-1	--	
381					
II	e1	02*0447	281	52	
II	E1	01*0447	281	52	
IV	e1	02*0448	281	52	
II	E1	01*0448	281	52	
IV	e1	02*0462	377	45,48	
IV	E1	01*0462	377	45,48	
II	e1	02*0463	378	48	
II	E1	01*0463	378	48	
V	e1	02*0464	379	--	
V	E1	01*0464	379	--	
II	e1	01*0469	385	70	
II	E1	01*0469	385	70	
II	e1	02*0487	372	--	
IV	e1	02*0488	372	--	
II	e1	02*0505	375	45	
398					
II	E1	01*0505	375	45	
398					
II	e1	02*0524	271	40,77	
276					
40					
363					
72					
373					
18,30					
380-1					
31					
II	E1	01*0524	271	40,77	
276					
40					
363					
72					
373					
18,30					
380-1					
31					
II	e1	02*0529	380-1	31	
III	e1	02*0569	198	--	
III	E1	01*0569	198	--	
II	e1	02*0620	273	--	
395					
II	e1	02*0646	392	32	
II	E1	01*0646	392	32	
V	e1	02*0647	284	--	
IV	E1	01*0647	393	32	
II	e1	02*0662	374 (LDV)	--	
II	e1	02*0688	405	--	
IV	e1	02*0689	406	--	
II	e1	02*0740	550	--	
IV	e1	02*0741	551	--	
V	e1	02*0742	552	21	
V	E1	01*0742	552	21	
II	e1	01*0798	901 (Iveco)	--	
VVI	E1	02*0894	552-1	21,59,63,70,71	
IIIII	E1	02*0902	589	54,55,66,67	
II	E1	02*0902	1039	57	
III	E1	02*0902	1039	57	
II	E1	02*0905	271	40,77	
276					
40					
373					
18,30					
380-1					
31					
IV	E1	02*0906	906	18	
II	E1	02*0910	274	--	
V	E1	02*0912	558	60,61,63	
IV	E1	02*0913	390	58,59,63	
II	E1	02*0914	390	58,59,63	
II	E1	02*0915	227	--	
IV	E1	02*0916	390	58,59,63	
IV	E1	02*0917	573	29,64	
II	E1	02*0918	572	29,64	
VVI	E1	02*0922	365-1	27	
394, 394-1					
II	E1	02*0923	271	40,77	
276					
40					
363					
72					
373					
18,30					
380-1					
31					
IV	E1	02*0924	393-1	33	
IV	E1	02*0924	393-2	34	
II	E1	02*0925	392-1	33	
II	E1	02*0925	392-2	34	
II	E1	02*0926	273	--	
395					
II	E1	02*0929	580	35	
IV	E1	02*0930	580	35	
VI	E1	02*0937	389	71	
II	E1	02*0939	380-1	31	
II	E1	02*0941	375	45	
398					
II	E1	02*0942	281	52	
II	E1	02*0951	278	41	

e	E	Typ	type	Тип	тип
		tipo	тип	Тип	тип
IV	E1	02*0952	278	41	
V	E1	02*0973	360-1	62	
V	E1	02*0998	395	52	
V	e1	*10025	156/4 BO	--	
I	e1	02*10041	202	--	
II	e1	*10042	152 AS	--	
III	E1	02*1020	922, 923	--	
V	e3	03*1021	463-1	--	
V	E3	01*1021	463-1	--	
III	E1	02*1021	922, 923	--	
IV	e3	03*1022	462	--	
IV	E3	01*1022	462	--	
IV	E1	02*1023	348	19,60	
V	e3	03*1031	1008	24,25	
V	e3	03*1034	1008	24,25	
IV	e1	02*1035	349 TW	53,65	
IV	e3	03*1036	1008	24,25	
VI	E1	02*1039	559	21,23	
VI	e3	03*1042	1008	24,25	
II	e9	01*1047	271	40,77	
276					
40					
373					
18,30					
IV	e9	01*1054	386	18,30	
II	e9	01*1063	460	--	
II	e9	01*1073	271	40,77	
276					
40					
373					
18,30					
IV	e9	01*1074	386	18,30	
V	e9	01*1075	463-1	--	
IV	e1	02*11001	260	26	
II	e1	*11002	156/6 BO	--	
IV	e1	02*11003	283	--	
IV	e1	*11004	266	27	
IV	e1	02*11005	268	--	
IV	e1	*11006	267	--	
IV	e1	02*11007	266	27	
IIIV	e1	02*11008	266, 266-1	--	
IIIV	E1	01*11008	266, 266-1	--	
IIIV	E1	02*11008	266, 266-1	--	
IV	e1	02*11009	266	27	
IV	e1	02*11010	462	--	
IV	E1	01*11010	462	--	
IV	e1	02*11011	367	--	
IV	e1	01*11011	367	--	
IV	e1	02*11012	285	--	
IV	E1	01*11012	285	--	
IV	e1	02*11013	268	--	
IV	e1	02*11014	267	--	
IV	e1	*11015	266	27	
IV	e1	02*11016	371	62	
IV	E1	01*11016	371	62	
II	E4	02*1104	110	--	
II	E4	01*1104	110	--	
II	e4	01*1106	257	--	
II	E1	02*1108	1000	65	
II	E1	02*1109	1000	65	
II	E1	02*1112	600	50	
IV	E1	02*1113	600	50	
VI	E1	02*1114	603	--	
II	E1	02*1144	575	46	
IV	E1	02*1145	577	46	
II	e6	01*116	250	62	
II	E1	02*1165	1009 / 1017	--	
V	e9	04*11687	279	25	
V	e9	04*11688	279	25	
V	E1	02*1178	1014	--	

List of homologation numbers Homologationsnummern

e	E	Typ • type tipo • тип	Tip	📖
II	e1	01*14068	254	44
II	e1	01*14069	258	--
II	E1	01*14069	258	--
II	e1	01*14070	254	--
II	e1	01*14071	255	--
			256	--
II	e1	02*14072	258	--
II	e1	02*14073	40.4495.222	--
			253	44
II	e1	01*14075	251	28
II	e1	02*14076	152 AS	--
II	e2	02*14080	364	28
II	e1	02*14082	364	28
II	E1	01*14082	364	28
II	e1	02*14083	282	--
II	E1	01*14083	282	--
II	e1	02*14084	282	--
II	e1	*14085	340 / 341	--
II	e1	*14086	253	44
II	e1	02*14087	340 / 341	--
II	e1	02*14088	249 L	--
II	e1	02*14089	252	62
II	E1	01*14089	252	62
II	e1	02*14090	251	28
II	e1	*14091	253	44
II	e1	02*14092	254	44
II	e1	*14093	253	44
II	e1	*14094	253	44
II	e1	01*14095	254	44
II	e1	01*14096	253	44
II	e1	02*14097	258	--
II	E1	01*14097	258	--
II	e1	02*14098	340 / 341	--
II	E1	01*14098	340 / 341	--
II	e1	02*14099	254	44
II	e1	02*14100	330 / 331	--
II	E1	01*14100	330 / 331	--
II	e1	02*14101	340 / 341	--
II	e1	02*14102	460	--
II	E1	01*14102	460	--
II	e1	02*14103	461	--
II	E1	01*14103	461	--
II	e1	02*14105	368	--
II	e1	02*14108	254	44
II	e1	02*14109	254	44
II	e1	02*14111	385	--
II	e1	02*14112	258	--
II	e1	02*14117	280	--
II	E1	01*14117	280	--
II	e1	01*14119	249 L	--
II	e1	02*14121	366	--
II	e1	02*14122	364/1	--
II	e1	02*14123	368	--
II	E1	01*14123	368	--
II	e1	01*14124	340 / 341	--
II	e1	02*14125	370	62
II	E1	01*14125	370	62
II	e1	02*14126	371	62
II	E1	01*14126	371	62
II	e1	02*14142	364	28
II	E13	02*1456	38.3730.410H	--
IV	e13	03*1457	906	18
II	E1	041459	1036	75
II	E1	041469	1039	56
II	E1	041480	1041	43
II	E1	041481	1041	43
IV	E1	041482	1041	43
II	E1	041540	1000	65
II	E1	041541	1000	65
IV	E1	041542	1024	36
II	E1	041543	1024	36
IV	e1	02*1550	264	--
V	e1	02*1551	264	--
II	e13	02*1558	253	44
II	E1	041619	1027	22
IV	E1	041620	1027	22
IV	E1	041620	1027	22
IV	E1	051696	1038	74
III	e1	01*17023	249 A	--
			249 K	53
II	e1	*17087	151 K	--
III	e1	01*17098	249 A	--
			249 K	53
II	e1	*17105	156/4 BO	--
II	e1	*17140	149 K	--
II	e1	01*17149	198	--
II	e1	01*17194	200 (Ford)	--
III	e1	02*17324	196	--
III	e1	02*17335	249 L	53
			*18792	29,64
II	e4	01*2067	254	44
II	e4	02*2069	259	--
II	E4	01*2069	259	--
II	E6	00*208	250	62
II	e4	01*2083	252	62
II	e1	03*0242	1000	65
II	e1	03*0243	1000	65

e	E	Typ • type tipo • тип	Tip	📖
II	e1	*2407	244 A	--
II	e4	03*2563	373	18,30
II	E4	02*2563	373	18,30
II	e1	*2901	156/6 BO	--
II	e3	*30011	472	--
II	e3	*30595	467	--
II	e2	01*307	291	78,79
II	e3	*32806	467	--
II	e3	*32906	472	--
II	e3	*32908	474 (Iveco)	--
II	e3	*33488	473 (Iveco)	--
II	e3	*33491	472	--
II	e3	*34767	472	--
II	e3	*35216	472	--
II	e3	*35433	472	--
II	e3	*35911	474 (Iveco)	--
II	e3	01*36030	474 (Iveco)	--
II	e3	*36709	340 / 341	--
II	e3	*36710	473 (Iveco)	--
II	e3	*36726	600 (Fiat)	--
II	e11	01*3701	255	--
II	e11	01*3706	364	28
II	e11	01*3709	257	--
II	e11	01*3716	253	44
II	e11	01*3717	252	62
II	e3	*37469	475 (Iveco)	--
II	e3	*38090	472	--
III	e	01*38334	600 (Fiat)	--
II	e3	01*38662	475 (Iveco)	--
II	e3	01*3890	472	--
II	e3	02*3890	472	--
II	e3	01*38930	475 (Iveco)	--
II	e3	01*38961	475 (Iveco)	--
II	e3	01*39267	475 (Iveco)	--
II	e3	02*39267	475 (Iveco)	--
II	e3	01*39542	475 (Iveco)	--
II	e3	*40142	250	62
II	e3	01*40458	473 (Iveco)	--
II	e3	02*40458	473 (Iveco)	--
II	e3	01*40459	473 (Iveco)	--
II	e3	02*40459	473 (Iveco)	--
II	e1	*4051	253	44
II	e3	*41511	475 (Iveco)	--
II	e3	01*41877	474 (Iveco)	--
II	e3	*42453	257	--
II	e3	01*42704	253	44
II	e3	01*42928	258	--
II	e3	02*43355	264	--
II	e3	02*43356	264	--
II	e3	02*43360	472	--
II	e3	*43611	364	28
II	E9	02*4395	286-1	--
II	e3	*44994	258	--
II	e17	00*46002	257	--
II	e3	02*46315	472	--
II	e3	02*46656	460	--
II	E3	01*46656	460	--
V	e3	02*46657	463-1	--
IV	e3	02*46658	462	--
IV	E3	01*46658	462	--
II	e3	02*46919	461	--
II	E3	01*46919	461	--
IVV	e11	01*5002	156/6 BO	--
II	e2	02*5004	348	19,60
IVV	e13	01*51370	264	--
II	e11	01*5340	253	44
II	e11	01*5343	257	--
II	e11	01*5383	258	--
II	e11	01*5387	255	--
II	e11	01*5392	364	28
II	e11	01*5393	254	44
II	e11	01*5394	252	62
II	e11	01*5395	251	28
II	e11	01*5396	341	26
IV	e11	01*5398	261	--
IV	e11	01*5399	266	27
IV	e11	01*5420	260	26
II	e11	01*5421	249 L	53
V	e11	01*5422	265	27
II	e11	01*5464	254	44
IVV	e11	01*5465	156/6 BO	--
III	e11	01*5502	200 (Ford)	--
II	e3	02*56297	348	19,60
II	E3	01*56297	470	--
II	e3	02*57571	461	--
II	E3	01*57571	461	--
II	e3	02*58121	460	--
II	E3	01*58121	460	--
IV	e3	02*58232	462	--
IV	E3	01*58232	462	--
II	e11	03*6208	224	64
II	E11	02*6208	224	64
IV	e11	03*6209	224	64
IV	E11	02*6209	224	64
IV	e9	03*6450	580	35
IV	e6	02*6565	261	--
II	e6	02*6566	252	62

e	E	Typ • type tipo • тип	Tip	📖
II	E6	00*6566	252	62
II	e9	02*6569	373	18,30
II	E9	02*6569	373	18,30
IV	E3	02*7010	462	--
IV	E3	02*7012	462	--
II	e3	03*7018	460	--
V	e3	03*7024	463-1	--
II	E6	00*7059	253	44
II	e6	02*7060	253	44
II	e2	02*717	289	72
II	e2	00*718	249 L	--
II	E13	08*7293	253	44
II	e2	02*739	253	44
II	e2	02*740	258	--
II	e2	02*752	286	--
II	E2	00*752	286	--
IVV	E2	00*753	287-1	--
II	E2	00*759	254	44
V	e6	02*8104	263	--
III	e13	00*86246	39.3730.210H	--
			39.3730.410H	--
IV	e13	01*87290	264	--
IV	E13	01*87290	264	--
V	e13	01*87291	264	--
IV	E13	01*87291	264	--



MEKRA Lang GmbH & Co. KG hat diesen Katalog sorgfältig verfasst. Das Unternehmen enthebt sich jeglicher Verantwortung für eventuelle Fehler oder Auslassung hinsichtlich Schemen, Zeichnungen, Übereinstimmung mit O.E. Codes usw. und behält sich das Recht vor, ohne Ankündigung, am Inhalt Veränderungen vorzunehmen. Anmerkungen, Fehlerhinweise und weitere Anregungen seitens der Kunden werden gerne entgegen genommen, um die nächste Ausgabe des Kataloges effizienter zu gestalten.

Die Vervielfältigung, auch teilweise, des urheberrechtlich geschützten Inhalts des vorliegenden Kataloges ist ohne schriftliche Genehmigung durch die **MEKRA Lang GmbH & Co. KG** untersagt.

Sämtliche im Katalog genannten Sachnummern der Fahrzeughersteller und deren Markennamen sowie Prüfnummern anderer Spiegelhersteller dienen lediglich zu Vergleichszwecken.



MEKRA Lang GmbH & Co. KG has devoted its best attention to the editing of this catalogue; it nevertheless declines any responsibility for possible mistakes or omissions regarding figures, drawings, correspondence with O.E. codes etc. and it reserves the right to modify the contents without prior notice. Users' comments, reports of inaccuracies or any other suggestions which may in any way improve the next edition of this catalogue are warmly welcomed.

It is forbidden to reproduce, even partially, the contents of this catalogue without prior written consent of **MEKRA Lang GmbH & Co. KG**, who will protect its right in accordance with the law.

All vehicle manufacturers' reference numbers, mentioned in the catalogue, as well as their brand names and approval numbers of other mirror manufacturers are only for identification purposes.

Vergleichsliste nach OE-Nummern Cross-reference-table

OE			
Agco			
F743810150020	40.1009.421.002	73	
F743810150030	40.1009.422.002	73	
Adria Mobil			
9090 83003 00	20.2710.650	41	
9095 83001 00	59.2760.005.001	--	
9095 83001 00 A	59.2761.302	--	
9095 83002 00	59.2760.006.001	--	
9095 83010 00	59.1018.001.099	76	
9095 83011 00	59.1018.002.099	76	
9095 83012 00	12.1018.001.099	76	
9095 83013 00	12.1018.002.099	76	
9095 83014 00	12.1018.007.099	76	
9095 83015 00	12.1018.009.001	76	
9095 83016 00	12.1018.010.001	76	
9095 83017 00	09.2910.005.099	76,79	
9095 83018 00	09.2910.002.099	76,79	
9095 83021 00	59.1018.025.001	--	
RD 322 077 0	11.3730.210H	18,40,72,77	
RD 322 244 0	19.1018.311.099	76	
Bürstner			
202204008	11.3730.210H	18,40,72,77	
2193829	12.1018.001.099	76	
2193831	12.1018.002.099	76	
2193831 MIT ANT	12.1018.012.001	--	
2193839	12.1018.009.001	76	
2193840	12.1018.010.001	76	
2193841	12.1018.007.099	76	
2218516	09.2910.002.099	76,79	
2218519	09.2910.005.099	76,79	
2247710	59.1018.021.001	--	
2247727	59.1018.022.001	--	
2247751	59.1018.023.001	--	
2276379	59.1018.007.099	76	
2304574	12.1018.005.099	76	
2613741	59.1018.025.001	--	
Z60000	20.2710.650	41	
298889	51.3200.147H	26	
68152322	59.2782.120	--	
70025517	59.2910.003.001	--	
70026237	59.2910.500.001	--	
70026787	59.2781.120	41	
70026788	20.2710.630	--	
70026789	59.2910.017.001	78	
7002690	61.2910.005.001	79	
7002692	09.2910.002.099	76,79	
70027178	61.2910.006.001	79	
70027665	51.2540.140H	44	
70028068	61.2530.110H	44	
70029007	59.2770.210.099	42	
70029251	15.2780.840	41,43,79	
70029917	19.2910.001.099	43,79	
70029941	15.2780.840	41,43,79	
70029942	15.2780.870	41	
70030418	59.2780.110	--	
70030686	11.2910.007.000	79	
70030687	11.2910.006.000	79	
70030688	20.2780.631	--	
70030875	19.2910.002.099	43,79	
70030923	59.2780.120.099	41	
70031268	11.2910.002.000	79	
70031577	11.2910.001.000	79	
70031996	11.2910.006.000	79	
70032095	11.2910.003.000	79	
70032122	61.2910.011.002	78	
70032360	59.2910.014.001	78	
70032377	59.2910.013.001	78	
70033394	59.2910.009.001	78	
70034438	61.2910.012.002	--	
70034479	19.2910.001.099	43,79	
70034480	19.2910.002.099	43,79	
70034551	59.2780.160.001	--	
70036218	61.2910.010.002	--	
70036219	11.2910.011.002	79	
70036220	61.2910.009.002	--	
70036705	15.3802.840H	72	
70037106	20.2710.620	40,41,81	
70037291	11.2910.012.002	79	
Carthago			
118016	20.2710.121	77	
118017	20.2710.630	--	
118023	20.2710.111H	77	
118029	20.2710.200H	40,77	
120665	56.3491.110H	53,65	
120666	56.3492.110H	53,65	
201619	12.1018.001.099	76	
201620	12.1018.002.099	76	
201621	12.1018.007.099	76	
201622	12.1018.007.099	76	
201623	12.1018.008.000	--	
201624	12.1018.008.000	--	
201931	09.2910.004.099	79	
201932	15.2780.841F	41,76,79	
201933	19.1018.311.099	76	
201934	19.1018.312.099	76	
203722	59.2910.019.001	78	

OE			
Carthago			
203723	59.2910.020.001	78	
207192	59.1018.007.099	76	
207193	59.1018.008.099	76	
207194	12.1018.005.099	76	
207195	12.1018.009.001	76	
207196	12.1018.010.001	76	
107977	51.1009.017.099	73	
110485	51.1009.246.001	--	
112137	51.2510.127H	28	
372807603	51.1009.025.099	--	
3728076-03	51.1009.025.099	73	
Case New Holland (CNH)			
00437650	51.3850.227	70	
47922739	51.1036.009.099	75	
47922741	51.1036.010.099	75	
47922743	51.1036.007.099	75	
47922744	51.1036.008.099	75	
48025196	19.1036.005.099	75	
48025209	19.1036.006.099	75	
Caterpillar			
236-5334	09.2500.300	--	
290-5544 / 319-6789	51.3635.201	72	
294-1991 / 316-6791	51.3635.204	72	
294-1992	51.3636.204	72	
308-3844	15.3731.470H	18,40,77	
319-6787	11.3730.210H	18,40,72,77	
319-6788	51.3636.201	72	
319-6790	51.3636.204	72	
372-8075	51.1009.017.099	73	
372-8076	51.1009.246.001	--	
415-3114	56.2660.147H	27	
436-2886	51.1009.027.099	73	
436-2887	51.1009.242.099	73	
436-2890	20.1016.004.000	82	
438-6751	09.3200.340	--	
443-2540	51.1009.248.001	--	
443-2541	51.1009.243.001	--	
443-2541	51.1009.244.001	--	
508-0795 ALT	51.1009.009.099	73	
526-5057	51.1009.001.099	73	
Claas			
11578380	40.1009.004.099	73	
11578530	11.1009.004.000	--	
11578540	51.1009.048.099	--	
11578550	40.1009.002.099	73	
11617700	11.1036.011.099	75	
11617720	11.1036.012.099	75	
11617730	19.1036.007.099	75	
11617740	19.1036.008.099	75	
11653120	40.1009.001.000	73	
11653140	40.1009.421.002	73	
11653170	40.1009.422.002	73	
11654100	51.1009.001.099	73	
11654110	61.1009.001.099	73	
11654120	61.1009.002.099	73	
11683170	40.1009.002.000	73	
11683190	51.1009.049.099	73	
1817890	11.3400.510	--	
21971360	51.1009.097.099	73	
22332170	51.1009.113.099	73	
26079370	51.1036.023.099	75	
26079500	51.1036.024.099	75	
26143870	51.1009.017.099	73	
30331340	8.1038.003.099	74	
30331350	8.1038.004.099	74	
5591600	56.2660.003.001	--	
5806090	40.3300.318	--	
5854370	51.3300.137	--	
6259300	40.3305.218	--	
6439980	56.2650.121H	27	
Concorde			
248268	59.2910.013.001	78	
248269	59.2910.014.001	78	
28421	15.2780.840	41,43,79	
284213	59.2910.019.001	78	
284214	59.2910.020.001	78	
284215	59.2910.001.001	78	
284215-01	11.2910.011.002	79	
284215-03	61.2910.011.002	--	
284215-07/28421	19.2910.001.099	43,79	
284215-10	15.2780.840	41,43,79	
284215-10/28421	15.2780.840	41,43,79	
284216	59.2910.002.001	78	
284216-01	11.2910.012.002	79	
284216-02	11.2910.008.000	79	
284216-03	61.2910.012.002	--	
284217	61.2910.021.001	79	
-- 284218	61.2910.022.001	79	
284217-3	61.2770.901.099	42	
284221	09.2910.002.099	76,79	
284222	20.2710.650	41	
284223	20.2710.630	--	
284224	59.2780.130	--	
2842241	11.2780.910	41	

OE			
Claas			
284225	59.2780.230	--	
2842251	11.2780.920	41	
284226	15.2711.114	40,77	
284228	15.2712.114	40,77	
284230	59.2710.401H	77	
284232	59.2710.402H	77	
284233	59.2710.406	77	
-- 284237	20.2710.500	--	
2842372	11.3730.210H	18,40,72,77	
284240	20.2480.216H	40,52,77,81	
284242	20.2480.217H	40,52,77,81	
284248	15.3731.470H	18,40,77	
284260	59.1018.003.099	76	
284261	59.1018.004.099	76	
284262	12.1018.001.099	76	
284263	12.1018.002.099	76	
284264	12.1018.003.099	76	
284265	12.1018.009.001	76	
284266	12.1018.010.001	76	
284267	09.2910.005.099	76,79	
284273	59.2910.009.001	78	
284274	59.2910.010.001	78	
-- 284277	59.2910.017.001	78	
284278	59.2910.018.001	78	
284281	19.2910.002.099	43,79	
284282	11.2910.016.000	--	
284283	11.2910.017.000	--	
284284	11.2910.014.000	--	
DAF			
1401046	59.5580.147	--	
1404849 / 1796325	40.3485.403H	19,60	
1404868	61.3482.149H	19,60	
1404871	61.3480.149H	19,60	
1405295	61.3480.149H	19,60	
1405350	61.3482.149H	19,60	
1409570	59.5580.147	--	
1409962	59.5580.247H	60,63</	

Vergleichsliste nach OE-Nummern Cross-reference-table

OE			
Liebherr			
11657854	58.1016.006.099		82
11657855	20.1016.004.000		82
11830241	11.1200.502.099		23
11830530	59.1005.004.001		--
11931048	20.2710.630		--
12218370	59.1005.004.001		--
12230063	40.1009.001.000		73
12230064	40.1009.003.099		--
12254474	09.3200.320H		80
12269787	58.1016.004.099		82
571070008	09.2070.101H	26,28,44,62,72,80	
571229808	40.2520.422H		62
571572108	09.3200.340		--
571572208	09.3200.220		80
571757008	08.3492.324.099		--
591055977	59.2640.110H		--
591056608	51.2520.147H		62
591059377	56.2660.127H		27
591060808	56.2640.127H		--
591061008	56.2661.147		--
591069208	09.3200.440		--
591070908	56.2630.127		--
591077608	58.2704.042		--
591080008	58.2486.507		--
7004956	51.1524.119H		72
7005028	51.3640.127		--
7017444	56.2660.127H		--
7021442	51.3640.147H		--
7022092	51.2461.117H		28
7616670	51.1523.121H		--
7619627	55.2021.177		--
7621216	20.2480.210H		81
7621717	51.2530.128H		--
Lindner			
3006104	51.3495.112H		65
3006232	56.3492.110H	53,65	
3006233	56.3491.110H	53,65	
3009960	51.1009.043.001		--
3009961	58.1017.011.099		74
3009999	58.1017.012.099		74
3010115	51.1009.001.099		73
3010188	51.1009.081.099		73
3010662	51.1009.017.099		73
3010850	51.1009.021.099		73
3010851	51.1009.022.099		73
3010852	51.1009.121.099		73
3010853	51.1009.122.099		73
3022116	40.1009.001.000		73
3205677	40.1009.004.099		73
3205678	40.1009.002.099		73
3207388	40.1009.002.000		73
3207415	11.1009.004.000		--
MAN			
11075175	59.2762.101		40
16100772027	09.3400.420	26,70,80	
33.25203-6001	08.2910.001.002	42,79	
33.25404-6190	09.2770.211	--	
33.28104-6355	09.1041.004.099		43
33.63700-6003	59.1042.005.099		43
33.63700-6004	59.1042.001.099		43
33.63730-6003	51.3635.206		72
33.63731-6002	58.2705.002		--
336373060001	51.3850.267		70
36.25404-6033	09.1041.002.099		43
36.63700-6017	59.1042.001.099		43
36.63700-6018	59.1041.001.099		43
36.63700-6019	59.1042.003.099		43
36.63700-6020	59.1042.004.099		43
36.63700-6022	59.1042.002.099		43
36.63730-6013	56.1523.117H		--
36.63730-6024	59.2910.500.001		--
36.63731-6000	20.2710.620	40,41,81	
36.63731-6001	20.2710.630		--
36.63731-6012	20.1042.002.099		43
36.63731-6013	20.1042.003.099		43
36.63732-0000	11.2770.102		42
36.63732-0001	11.2770.302		42
36.63732-0002	11.2770.202		42
36.63732-0003	11.2770.402		42
36.63732-0004	11.2770.620		--
36.63732-0006	11.2780.920		41
36.63732-0024	61.2910.009.002		--
36.63732-0033	12.1041.004.099		43
36.63732-0034	12.1041.003.099		43
36.63732-0036	12.1041.005.099		43
36.63732-0037	12.1041.001.099		43
36.63732-0040	12.1042.001.099		43
36.63732-0041	12.1042.002.099		43
36.63732-0044	11.2910.017.000		--
36.63732-6000	61.2770.900.099		42
36.63733-0009	19.2910.002.099	43,79	
36.63733-0010	19.2910.001.099		43
36.63733-0011	15.2780.840		43
36.63733-0012	19.2910.002.099		43
36.92611-0002	11.2770.040		--

OE			
MAN			
65.63733-0002	19.1013.011.099		39
65.63733-0006	19.1013.013.099		39
65.63733-0014	19.1013.013.009		39
65.63733-0015	19.1013.011.099		39
81.25404-6247	09.3200.310H		--
81.25406-6252	09.3200.360		--
81.25432-0149	09.2070.101H	26,28,44,62,72,80	
81.25505-6247	08.2770.001.000		42
81.25525-0232	08.3200.233H	41,42,76,79,80	
81.62410-0107	20.5800.710H		35
81.62410-0108	20.5800.720H		35
81.62410-0109	20.5800.750H		35
81.62730-6221	51.3410.147H		26
81.63732-0089	61.2772.100		42
81.63730-0032	40.3640.422H	26,28	
81.63730-6432	51.3922.222H		32
81.63730-6127/-6167	51.2510.127H		28
81.63730-0032	40.3640.422H	26,28	
81.63730-0058	08.3400.324		--
81.63730-0067	15.3731.074H		30
81.63730-0082	61.2770.110		--
81.63730-0083	61.2770.210		42
81.63730-0066	15.3731.070H		30
81.63730-6001	51.3640.147H		28
81.63730-6003	40.3640.422H	26,28	
81.63730-6016	51.3400.147H		26
81.63730-6094	51.2460.218H		--
81.63730-6108	51.3640.127H		28
81.63730-6126	51.3640.127H		28
81.63730-6128	51.2510.147H		28
81.63730-6138	56.1562.110		--
81.63730-6147	51.3640.613H		28
81.63730-6148	51.3640.127H		28
81.63730-6149	51.3640.127H		28
81.63730-6151	51.3640.147H		28
81.63730-6193	51.3200.147H		26
81.63730-6194	51.3640.127H		28
81.63730-6202	40.3640.422H	26,28	
81.63730-6203	40.3640.422H	26,28	
81.63730-6206	56.2600.127H		26
81.63730-6220	51.3410.127H		26
81.63730-6221	51.3410.147H		26
81.63730-6222	56.2660.127H		27
81.63730-6223	56.2660.147H		27
81.63730-6224	56.2660.121H		27
81.63730-6233	51.3410.127H		26
81.63730-6234	51.3410.147H		26
81.63730-6235	56.2660.127H		27
81.63730-6236	56.2660.147H		27
81.63730-6237	59.2652.110H		27
81.63730-6294	59.3652.128H		27
81.63730-6295	59.3652.147H		--
81.63730-6296	59.3652.167H		--
81.63730-6299	56.2660.147H		27
81.63730-6303	51.3736.121H		30
81.63730-6305	51.3736.126H		30
81.63730-6306	56.3860.112H		30
81.63730-6307	56.3860.114H		30
81.63730-6308	56.3862.116H		30
81.63730-6314	51.3735.121H		30
81.63730-6315	51.3735.124H		30
81.63730-6316	51.3735.126H		30
81.63730-6317	56.3861.116H		30
81.63730-6328	56.3862.116H		30
81.63730-6331	51.3735.121H		30
81.63730-6332	51.3736.121H		30
81.63730-6345	51.3921.222H		32
81.63730-6347	51.3922.222H		32
81.63730-6350	56.3932.222H		--
81.63730-6351	56.3931.222H		--
81.63730-6361	51.3735.124H		30
81.63730-6362	51.3736.124H		30
81.63730-6363	51.3735.126H		30
81.63730-6364	51.3736.126H		30
81.63730-6365	51.3735.124H		30
81.63730-6366	51.3736.124H		30
81.63730-6367	51.3735.126H		30
81.63730-6368	51.3736.126H		30
81.63730-6369	51.3922.232H		--
81.63730-6373	08.3492.324.099		--
81.63730-6374	51.3732.326	40,77	
81.63730-6375	51.3731.326	40,77	
81.63730-6390	51.3732.326	40,77	
81.63730-6394	51.3924.222H		--
81.63730-6395	51.3921.222H		32
81.63730-6398	51.3923.222H		32
81.63730-6401	51.3922.232H		--
81.63730-6409	56.3931.222H		--
81.63730-6410	56.3932.222H		--
81.63730-6420	51.3412.120H		26
81.63730-6421	56.2662.120H		27
81.63730-6430	51.3921.222H		32
81.63730-6431	51.3924.222H		--
81.63730-6432	51.3922.222H		32
81.63730-6433	51.3923.222H		32
81.63730-6434	51.3922.232H		--
81.63730-6443	56.3931.222H		--

OE			
MAN			
81.63730-6444	56.3932.222H		--
81.63730-6480	51.3921.223H		33
81.63730-6481	51.3922.223H		33
81.63730-6482	51.3921.224H		33
81.63730-6483	51.3922.224H		33
81.63730-6484	51.3924.223H		--
81.63730-6485	51.3923.223D		33
81.63730-6486	51.3924.224H		33
81.63730-6487	51.3923.224H		33
81.63730-6492	51.3922.233H		--
81.63730-6510	56.3931.343H		33
81.63730-6511	56.3932.343H		33
81.63730-6512	56.3931.323H		33
81.63730-6513	56.3932.323H		33
81.63730-6529	59.5800.101H		35
81.63730-6531	59.5800.201H		35
81.63730-6533	59.5800.121H		35
81.63730-6534	59.5800.221H		35
81.63730-6549	59.5800.122H		35
81.63730-6550	59.5800.222H		35
81.63730-6551	59.5800.422H		35
81.63730-6552	59.5800.322H		35
81.63730-6553	59.5800.223H		35
81.63730-6560	59.5800.102H		35
81.63730-6561	59.5800.202H		35
81.63730-6562	59.5800.402H		35
81.63730-6563	59.5800.302H		35
81.63730-6564	59.5800.203H		35
81.63730-6573	56.5790.004.099	29,32,47,49	
81.63730-6574	56.5790.003.099	29,32	
81.63730-6578	56.5790.002.099	34,35	
81.63730-6737	56.5790.004.099	29,32,47,49	
81.63730-6734	56.5790.003.099	29,32	
81.63730-6735	56.5790.002.099	34,35	
81.63730-6738	51.3920.002.099		34
81.63730-6739	51.3920.001.099		34
81.63730-6740	51.3920.003.099		34
81.63730-6741	51.3920.013.099		34
81.63730-6742	51.3920.005.099		34
81.63730-6744	51.3920.012.099		34
81.63730-6745	51.3920.004.099		34
81.63730-6746	51.3920.014.099		34
81.63730-6748	56.3930.004.099		34
81.63730-6749	56.3930.002.099		34
81.63730-6750	56.3930.003.099		34
81.63730-6751	56.3930.001.099		34
81.63730-6753	51.5720.001.099		--
81.63730-6754	56.2660.002.099		27
81.63730-6755	59.5800.122H		35
81.63730-6756	59.5800.102H		35
81.63730-6757	59.5800.422H		35
81.63730-6758	59.		

Cross-reference-table Vergleichsliste nach OE-Nummern

Table with columns for OE, MAN, and various part numbers. Includes a small icon in the top right of the header.

Table with columns for OE, MAN, and various part numbers. Includes a small icon in the top right of the header.

Table with columns for OE, Mercedes, and various part numbers. Includes a small icon in the top right of the header.

Vergleichsliste nach OE-Nummern Cross-reference-table

OE		
Mercedes		
0028115633	19.5891.011.099	55,67
0028115733	19.5891.012.099	55,67
0028116333	15.6000.001.099	50
0028116433	15.6000.002.099	50
0028116533	15.6000.003.099	50
0028116633	15.6000.004.099	50
2818107116	51.2530.120H	44
3018102116	51.2530.140H	44
3148101316	51.2540.120H	44
3148101916	51.2540.130H	44
3148102016	51.2540.140H	44
3148102616	51.2530.140H	44
3568100611	20.2480.213	77,81
3600100512654	58.2704.048	83
3818102516	51.2530.120H	44
3818102616	51.2530.140H	44
3818107116	51.2530.120H	44
3818107316	51.2530.140H	44
6118100116	51.3490.110H	53
6228100116	59.3980.141	52
6288103016	59.3980.121	52
6288103116	59.3980.122	52
6288103316	59.3980.111	52
6288103416	59.3980.112	52
6288103616	59.3980.131	--
6288103716	59.3980.132	52
6298110033	15.3951.174	52
6298110133	15.3951.114	52
6298110233	15.3952.174	--
6338100216	59.3980.142	52
6418104216	51.3680.147H	--
6418104416	51.3680.167H	--
6418106816	51.3680.147H	--
6638100816	51.2530.120H	44
6718100095	20.2710.620	40,41,81
6718100716	59.3980.011H	52
6718100916	59.3980.021H	52
6718101316	59.3980.022H	52
6718101111	20.2480.210H	81
6738100816	51.2530.120H	44
6738103916	51.2540.120H	44
6738104016	51.2530.120H	44
6738104116	51.2540.140H	44
6738104216	51.2530.140H	44
86880001840	51.3640.127	--
86880320130	10.6321.100	26,27
86880410010	40.2500.222H	62
86880410290	10.6121.100	26,28
86880751690	08.2810.124	--
86880902140	11.2810.200H	52
86880902250	20.2810.310	--
87480181000	51.2510.127H	28
89199311514	08.3200.500	--
89199718444	40.2540.422H	44
8919978658	40.2540.422H	44
9018100116	51.3490.110H	53
9018100216	51.3490.120H	53
9018100916	51.3490.112H	53
9018101016	51.3490.122H	53
9018101093	56.3491.110H	53,65
9018101193	56.3492.110H	53,65
9018102516	59.3491.110H	53
9018102616	59.3491.120H	53
9018103716	59.3492.110H	53
9018103816	59.3492.120H	53
9018105716	51.3490.112H	53
9018105816	59.3491.110H	53
9018106116	59.3492.110H	53
9018106416	51.3490.120H	53
9018106616	51.3490.122H	53
9018106716	59.3491.120H	53
9018107016	59.3492.120H	53
9068101893	51.5891.111.199	54,66
9068101993	51.5891.211.199	54,66
9068102093	51.5891.411.199	54,66
9068102293	51.5892.111.199	54,66
9068102393	51.5892.211.199	54,66
9068102493	51.5892.411.199	54,66
9068102593	51.5892.311.199	54,66
9068102693	51.5893.111.199	54,66
9068102793	51.5893.211.199	54,66
9068103093	51.5891.112.199	--
9068103193	51.5891.212.199	--
9068103293	51.5891.412.199	--
9068103393	51.5891.312.199	--
9068103493	51.5892.112.199	--
9068103593	51.5892.212.199	--
9068103693	51.5892.412.199	--
9068103793	51.5892.312.199	--
9068103893	51.5893.112.199	--
9068103993	51.5893.212.199	--
9068104293	51.5891.114.199	--
9068104393	51.5891.214.199	--
9068104493	51.5891.414.199	--
9068104593	51.5891.314.199	--
9068104816	51.5891.111.199	54,66
9068104916	51.5891.211.199	54,66

OE		
Mercedes		
9068105016	51.5891.411.199	54,66
9068105116	51.5891.311.199	54,66
9068105216	51.5892.111.199	54,66
9068105316	51.5892.211.199	54,66
9068105416	51.5892.411.199	54,66
9068105516	51.5892.311.199	54,66
9068105616	51.5893.111.199	54,66
9068105716	51.5893.211.199	54,66
9068106016	51.5891.113.199	54,66
9068106116	51.5891.213.199	54,66
9068106216	51.5891.413.199	54,66
9068106316	51.5891.313.199	54,66
9068106393	51.5894.410.199	54,66
9068106416	51.5892.113.199	54,66
9068106493	51.5894.310.199	54
9068106516	51.5892.213.199	54,66
9068106593	51.5894.112.199	--
9068106616	51.5892.413.199	54,66
9068106693	51.5894.212.199	--
9068106716	51.5892.313.199	54,66
9068106816	51.5893.113.199	54,66
9068106916	51.5893.213.199	54,66
9068107993	51.5895.412.199	--
9068108093	51.5895.312.199	--
9408100516	59.3964.210H	47
9418101016	59.3792.127H	--
9418102116	59.3792.127H	--
941810007	20.3780.700H	48
9438104716	59.3965.210H	49
9738100314	58.3752.100	45
9738100414	58.3752.200H	45
9738107316	59.3962.210H	47
0001590268	09.3200.320H	80
0008100102	51.5720.001.099	--
0008100211	20.2810.110H	--
0008100412	61.2703.110	83
0008100512	61.2703.120	83
0008100617	51.2500.127H	62
0008101613	11.3001.100	--
0008103716	51.2520.147H	62
0008105316	51.3200.147H	26
0008108316	51.3410.147H	26
0008110135	14.2530.100	--
0008110818	11.3491.200	--
0008110839	11.3491.300	--
0008114730	51.3209.197	--
0008115130	51.3490.282E	--
0008115330	51.3490.272E	--
0008115530	51.3490.182E	--
0008115730	51.3491.102.099	--
0008115630	51.3491.101E	--
0008117733	40.3200.422H	26
0008119133	40.3665.118F	--
0008205198	10.6221.100	28,70,72
0008205198	10.6221.100	28,70,72
0008210929	10.6211.140	--
0018106116	15.2712.114	40,77
0018107216	51.3731.326	40,77
0018111433	40.2660.404H	27
0018210029	10.6221.100	28,70,72
0018271104	09.2810.220	--
0028104216	51.3770.001.002	--
0028106016	56.1004.001.099	47,49,50
0048204715	09.3200.360	--
3568100611	20.2480.213	77,81
3578110471	11.3730.210H	18,40,72,77
3818107216	51.2530.130H	--
4068105216	51.1522.211H	--
4168100416	51.1523.111H	--
6298100416	59.3951.300	--
6298110133	15.3951.114	52
9108100300	59.1039.125.099	56
9108100400	59.1039.225.099	56
9108100401	59.1039.525.099	57
9108100500	59.1039.175.099	56
9108100501	59.1039.625.099	57
9108100600	59.1039.275.099	56
9108100601	59.1039.575.099	57
9108100701	59.1039.675.099	57
9108100801	59.1039.501.099	57
9108100901	59.1039.601.099	56
9108101001	59.1039.551.099	57
9108101100	59.1039.104.099	56
9108101101	59.1039.651.099	57
9108101200	59.1039.204.099	56
9108101300	59.1039.154.099	--
9108101400	59.1039.254.099	56
9108101601	59.1039.701.099	57
9108101701	59.1039.801.099	57
9108101801	59.1039.751.099	57
9108101900	59.1039.105.099	56
9108101901	59.1039.851.099	57
9108102000	59.1039.205.099	56
9108102100	59.1039.155.099	56
9108102200	59.1039.255.099	56
9108107001	59.1039.558.099	57
9108107101	59.1039.658.099	57

OE		
Mercedes		
9108108901	59.1039.101.099	56
9108109001	59.1039.201.099	56
9108109101	59.1039.151.099	56
9108109201	59.1039.251.099	56
9108109501	59.1039.158.099	56
9108109601	59.1039.258.099	56
9108112400	19.1039.412.099	56
9108112500	19.1039.411.099	56
9108112600	19.1039.012.099	56
9108112700	19.1039.011.099	56
9108112800	19.1039.812.099	56
9108112900	19.1039.811.099	56
9108113600	19.1039.312.099	56
9108113700	19.1039.311.099	56
9108113800	11.1039.012.099	56
9108113900	11.1039.011.099	56
9108114000	13.1039.002.099	56
9108114100	13.1039.001.099	56
9108114400	11.1039.002.099	56
9108114500	11.1039.001.099	56
9108250400	61.1039.002.099	56
9109064600	08.1039.002.099	56
9109064700	08.1039.001.099	56
9109065600	08.1039.011.099	56
9578110033	40.3605.204F	62
66560398	56.3492.110H	53,65
Morelo		
205804	59.1018.007.099	76
205805	59.1018.008.099	76
205815	12.1018.001.099	76
205816	12.1018.002.099	76
205820	12.1018.005.099	76
205822	12.1018.009.001	76
205824	12.1018.010.001	76
205825	09.2910.005.099	76,79
205826	09.2910.002.099	76,79
Niesmann + Bischoff		
0866048	59.3601.128H	62
10222	59.3601.128H	62
12667	59.2761.302	--
21082	15.2780.841F	41,76,79
22922	59.1018.007.099	76
25032	19.1018.311.099	76
28852	12.1018.010.001	76
288523	12.1018.009.001	76
8002710	59.2761.302	--

Cross-reference-table Vergleichsliste nach OE-Nummern

OE			
Plaxton			
AP119170C-10	11.2910.003.000	79	
AP119170C-10	59.2910.003.001	78	
AP119170C-100	59.2910.003.001	78	
AP119170C-11	11.2910.006.000	79	
AP119170C-12	11.2910.008.000	79	
AP119170C-13	11.2910.002.000	79	
AP119170C-14	61.2910.011.002	--	
AP119170C-15	11.2910.007.000	79	
AP119170C-16	61.2910.012.002	--	
AP119170C-17	11.2910.011.002	79	
AP119170C-18	11.2910.012.002	79	
AP119170C-2	59.2910.010.001	78	
AP119170C-5	61.2910.009.002	--	
AP119170C-6	61.2910.019.002	--	
AP119170C-7	19.2910.001.099	43,79	
AP119170C-9	11.2910.001.000	79	
AP138271C-1	11.2780.510	--	
AP138271C-2	11.2780.910	41	
AP138271C-3	15.2780.870	41	
AP138274C	59.2780.180.001	41	
AP138274C-1	11.2780.520	--	
AP140857C-1	59.2910.009.001	78	
AP140857C-3	61.2910.005.001	79	
AP140857C-4	61.2910.006.001	79	
APAA-01976-4	11.3730.210H	18,40,72,77	
APAA-01976-6	09.3200.360	--	
APAA-01983-3	20.2710.500	--	
P105367C15	20.2480.210H	81	
P107424C10	20.2480.216H	40,52,77,81	
P119170C-3	61.2910.003.001	79	
P119170C-4	61.2910.004.001	79	
P119170C8	15.2780.840	41,43,79	
PAA01976-1	51.3731.326	40,77	
PAA019762	15.3731.470H	18,40,77	
PAA019763	15.2711.114	40,77	
PAA019771	51.3732.326	40,77	
PAA019774	15.2712.214	40,77	
PAA-01985	09.3200.220	80	
Renault			
5001856290	61.3481.149H	19,6	
5010578503	59.3900.123H	59	
5010578504	59.3900.223H	59	
5010578505	59.3901.123H	--	
5010578506	59.3901.223H	--	
5010578511	59.5580.247H	60,63	
5010623057	20.3900.510H	58,59,63	
5010623058	20.3900.520H	58,59,63	
5010623231	59.3900.143H	58,63	
5010623232	59.3900.243H	58,63	
5010623246	59.3900.133H	58,63	
5010623247	59.3900.233H	63	
5010623689	59.3901.143H	--	
5010623690	59.3901.243H	--	
5010623698	59.3901.233H	--	
7420849799	59.5524.748.099	--	
7420849835	59.5524.649.099	59	
7420849837	59.5524.648.099	59,63	
7420849852	59.5524.640.099	--	
7420850409	20.5520.250H	--	
7420862779	11.3900.200H	58,63	
7420862782	61.3900.100H	58,59,63	
7420862795	15.3900.840H	58,59,63	
7420862800	11.3910.200H	58,63	
7420862809	61.3911.110H	58,63	
7420862810	15.3911.871H	58,63	
7420862812	08.5752.024.099	41,42,58,59,63	
7420862813	61.3911.120H	58,63	
7420862815	15.3911.872H	58,63	
7420866665	61.3900.110H	58,59,63	
7420866672	08.5752.024.099	41,42,58,59,63	
7420903714	11.3900.201H	--	
7420903722	58.3900.143H	--	
7420903723	58.3900.133H	--	
7420903727	58.3900.243H	--	
7420903732	58.3900.233H	--	
7420903736	11.3910.201H	--	
7420903880	11.3900.100H	59	
7420903881	11.3900.101H	--	
7420913815	61.3900.120H	58,59,63	
7421020285	51.5524.930H	59,63,71	
7421164788	59.5524.730.099	--	
7421276373	61.3482.149H	19,6	
7421326526	59.3900.233H	63	
7421326527	59.3900.243H	58,63	
7421326550	59.3900.223H	--	
7421326551	59.3901.223H	--	
7421326554	59.3901.233H	--	
7421326558	59.3901.243H	--	
7421346867	20.5520.250H	--	
7421614025	09.3900.003.000	58,59,63	
7421618499	08.5752.024.099	41,42,58,59,63	
7478493162	59.1025.003.099	--	
7482226023	59.5524.640.099	--	
7482226025	59.5524.648.099	59,63	
7482226027	59.5524.649.099	59	
7482265705	59.5524.748.099	--	

OE			
Renault			
7482408450	19.1033.001.199	58	
7482408451	19.1033.002.199	58	
7484531138	59.1025.001.099	21,60,64	
7484531168	59.1025.002.099	21,60,64	
7485120820	61.3900.120H	58,59,63	
Scania			
102088 / 2081428	55.3000.117	--	
108832	11.3001.100	--	
129429	20.2700.200H	40,77	
1441529	59.2706.121	--	
1441530	59.2706.101	--	
1441533	59.2706.124	--	
1441534	59.2706.104H	--	
1448217	20.2480.210H	81	
1451226	20.2480.216H	40,52,77,81	
1451227	20.2480.211H	81	
1485117	59.2706.203	--	
1485118	59.2706.232	--	
1505201	15.3731.470H	18,40,77	
1505202	11.3730.210H	18,40,72,77	
1505203	61.2708.842H	83	
1522365	21.2706.100	--	
1522366	21.2706.110	--	
1522367	09.3200.360	--	
1543451	51.2510.127H	28	
1742422	09.3200.310H	--	
1763444	51.1524.117	81	
1767265	15.4001.740H	61	
1805203	51.3732.326	40,77	
1857128	59.2706.302	--	
1880287	20.2710.121	77	
1880288	20.2710.111H	77	
1880289	59.2715.101.099	--	
1880290	59.2715.102	--	
1880295	20.2710.200H	40,77	
1886454	40.2510.222H	28	
1893487	51.3635.206	72	
1893489	15.3802.840H	72	
1893532	51.3731.326	40,77	
1895048	51.3732.326	40,77	
1915758	20.2700.260	--	
1946640	15.2712.113F	77	
2081428	55.3000.108H	--	
2092223	55.2462.117	--	
2092593	08.5752.024.099	41,42,58,59,63	
2116023	56.1020.020.099	61	
2116845	19.1019.013.099	61	
2116846	19.1019.014.099	61	
2116848	19.1019.313.099	61	
2116849	19.1019.314.099	61	
2118477	12.1020.003.099	61	
2127721	55.2561.111.001	--	
2239699	59.2706.005.001	--	
22479890	11.2770.920	42	
2248592	56.2660.002.099	27	
2249381	19.1020.213.099	61	
2249382	19.1020.613.099	61	
2252649	58.2706.002.001	--	
2252652	58.2706.104H	--	
2332206	09.3200.320H	80	
2382791	59.1005.003.099	61	
2411114	59.2770.210.099	42	
2434918	55.2561.111.001	--	
2530656	09.2910.002.099	76,79	
2530662	59.2910.004.001	78	
2530663	59.2910.001.001	--	
2537657	61.2910.009.002	--	
2537709	11.2910.003.000	79	
2537712	11.2910.011.002	79	
2537714	19.2910.001.099	43,79	
2537717	61.2910.011.002	--	
2537719	11.2910.008.000	79	
2537720	11.2910.012.002	79	
2537722	61.2910.020.002	--	
2537723	11.2910.017.000	--	
2537726	61.2910.012.002	--	
2541253	61.2910.005.001	79	
2541254	11.2910.001.000	79	
2541255	11.2910.002.000	79	
2541259	61.2910.006.001	79	
2541260	11.2910.006.000	79	
2541261	11.2910.007.000	79	
2541262	19.2910.002.099	43,79	
2548189	15.2780.840	41,43,79	
2556182	59.2782.120	--	
2567224	59.2910.010.001	78	
2567225	59.2910.017.001	78	
2577310	09.3200.330	--	
2599501	61.2910.019.002	--	
2599528	61.2910.010.002	--	
2599529	11.2910.014.000	--	
2599530	11.2910.016.000	--	
2723896	59.2770.310.099	42	
2728569	59.2770.211.099	42	
2729143	59.1041.001.099	43	
2729156	59.1042.003.099	43	

OE			
Scania			
2729158	59.1042.001.099	43	
2739165	11.2770.102	42	
2739167	15.2771.840	42	
2739168	15.2771.870	42	
2760509	59.2910.012.001	78	
2794079	08.2910.001.002	42,79	
2911918	09.1041.002.099	43	
2926677	15.2780.870	41	
3070159	51.3000.002.001	71	
3070160	61.3000.004.001	71	
3139595	08.1024.124.099	43	
437489	51.2540.148	--	
437491	58.2481.012	--	
639093	14.2530.100	--	
639141	61.2530.110H	44	
9006839	05.3308.100	--	
SIAC			
166351394	40.1009.004.099	73	
166352077	40.1009.002.099	73	
166428555 - ALT	51.1009.048.099	--	
620031733 - ALT	59.1017.003.099	74	
620031734 - ALT	59.1017.004.099	74	
620102328 - ALT	51.1009.017.099	73	
620102331 - ALT	51.1009.113.001	--	
620102332 - ALT	51.1009.009.099	73	
620102081 - ALT	58.1017.005.099	74	
620102082 - ALT	58.1017.006.099	74	
620102083 - ALT	58.1017.011.099	74	
620102084 - ALT	58.1017.012.099	74	
620186052	09.3200.420H	26,73,75	
SOLARIS			
0000-059-207	11.2770.102	42</	

Vergleichsliste nach OE-Nummern Cross-reference-table

OE			
Tatra			
443332041000	51.3300.149	--	
443332042000	59.3601.128H	62	
443332051000	51.3635.206	72	
443332052000	51.3636.206	72	
443332058000	51.3635.216	--	
443332059000	51.3636.216	--	
443400151000	51.3300.147H	--	
990115703000	15.3802.840H	72	
990115704000	40.3605.203H	62	
Temsa			
5053APA03Y	61.2910.004.001	79	
5053APA0401Y	15.2780.840	41,43,79	
5053APA0403Y	19.2910.001.099	43,79	
5053APA04Y	59.2910.002.001	78	
5053APA05Y	61.2910.003.001	79	
5053APA06Y	59.2910.001.001	78	
HD301144-02Y	19.2910.002.099	43,79	
HD3011444Y	59.2910.004.001	78	
HD301151	61.2910.006.001	79	
HD301152	61.2910.005.001	79	
MD301145Y	59.2910.010.001	78	
Terex			
103724	51.1523.121H	--	
105518	55.2020.171	--	
27230912	59.5524.530H	71	
48092012	15.3802.840H	72	
5253100003	51.3640.127	--	
5653634760	51.1523.111H	--	
5653634770	51.1524.118	--	
5653634775	51.2500.127H	62	
5653634816	51.2500.147H	62	
5653634822	51.2493.137H	--	
5653634825	51.1009.017.099	73	
5653634830	51.1009.089.099	--	
5653634836	40.1009.001.000	73	
5653634837	40.1009.002.000	73	
VDL			
20510114	51.2530.148H	--	
24012180000	51.2530.128H	--	
28250087	55.2561.110	--	
30014897	59.2770.210.099	42	
30014898	59.2780.120.099	41	
30016869	11.2780.910	41	
30017252	15.2780.870	41	
30017729	59.2710.402H	77	
30017737	51.3732.326	40,77	
30017741	15.3731.470H	18,40,77	
30017752	11.3730.210H	18,40,72,77	
30017839	55.2561.010	--	
30017840	15.2561.640	--	
30017844	15.2771.870	42	
30017845	20.2780.830	--	
30017846	15.2780.840	41,43,79	
30017876	15.2780.840	41,43,79	
30022423	51.3731.326	40,77	
30032132	55.2561.110	--	
30045213	11.2770.202	42	
30045214	11.2770.302	42	
30045215	11.2770.402	42	
30102976	20.2710.630	--	
30103263	11.2780.510	--	
30103281	61.2770.210	42	
30103282	61.2770.211	42	
30103284	11.2780.920	41	
30103285	11.2780.520	--	
30103286	59.2780.150.001	41	
30110912	09.2910.006.001	--	
30120778	59.2712.111	40	
30120779	59.2712.114	40	
30120780	20.2480.222	--	
30120781	20.2480.221	--	
30121356	59.2910.024.001	--	
30121358	59.2910.023.001	--	
30121380	61.2910.027.001	--	
30121381	61.2910.026.001	--	
30127115	59.2706.006.001	--	
30130954	51.3635.206	72	
30130955	15.3802.840H	72	
30130962	11.2910.001.000	79	
30130963	11.2910.006.000	79	
30130964	11.2910.003.000	79	
30130965	11.2910.008.000	79	
30130967	11.2910.012.000	--	
30130970	61.2910.009.002	--	
30130971	61.2910.019.002	--	
30130972	19.2910.001.099	43,79	
30130975	61.2910.010.002	--	
30130976	61.2910.020.002	--	
30130977	11.2910.016.000	--	
30130978	11.2910.017.000	--	
30130979	11.2910.014.000	--	
30130981	19.2910.002.099	43,79	
30130982	61.2910.011.002	--	
30130983	61.2910.012.002	--	

OE			
VDL			
30130985	11.2910.002.000	79	
30130986	11.2910.007.000	79	
30139755	59.2910.027.001	--	
30162330	55.3000.117	--	
30162331	61.3000.002.001	71	
30172295	59.2760.007.001	--	
30172762	11.2770.040	--	
30172776	61.2770.900.099	42	
30184984	61.2910.006.001	79	
30184985	61.2910.005.001	79	
30207377	59.2910.500.001	--	
30218618	20.2760.140	--	
30218619	20.2760.150	--	
30218620	51.3636.206	72	
30218738	09.2910.003.099	42,79	
30218739	08.3950.001.099	42,79	
30226914	12.1018.002.099	76	
30226915	19.1018.314.000	--	
30243430	12.1018.001.099	76	
31041266	08.2910.001.002	42,79	
53707213480217	20.2480.217H	40,52,77,81	
60000269	58.2601.010	--	
60000270	09.3200.320H	80	
H28250077	51.2500.167H	--	
HJ24013370	51.3850.147H	70	
J24013361200	09.3200.320H	80	
P758200126	59.2710.401H	77	
P759001645	20.2480.216H	40,52,77,81	
P759001646	20.2480.217H	40,52,77,81	
Viscon			
44152400300	09.2910.002.099	76,79	
44176040317	59.2910.001.001	78	
44176040318	59.2910.002.001	78	
44176040321	59.2910.003.001	78	
44176040322	59.2910.004.001	78	
Volvo			
22210899	58.2704.065	--	
23227102	61.1000.004.099	65	
0331121	20.2710.121	77	
1096643	59.3601.128H	62	
1581550	51.2500.127H	62	
1581599	40.2500.222H	62	
1581602	40.2500.422H	62	
1581616	51.2500.147H	62	
1594411	51.2500.147H	62	
1594412	51.2500.147H	62	
1594415	40.2500.422H	62	
1594902 / 1621353	51.2520.147H	62	
1195934 / 3090396	51.2520.147H	62	
1599462	51.2520.127H	62	
161 00 77 0005	51.3200.147H	26	
16281990	51.1009.025.099	73	
16315898	55.2020.177H	--	
1697007	40.2520.422H	62	
1697927	14.2530.100	--	
1697928	61.2530.110H	44	
17452496	51.1009017099	73	
20207881	59.3900.143H	58,63	
20515454	20.2480.223	81	
20523873	59.2710.410	--	
20523877	59.2710.409	--	
20526284	09.3200.320H	80	
20526353	56.2660.127H	27	
20540638	20.2710.500	--	
20548032	56.2660.147H	27	
20548137	58.2600.010H	--	
20564284	58.2704.086	83	
20567670	15.2240.840H	64	
20707812	59.5580.247H	60,63	
20707874	59.3900.133H	58,63	
20707881	59.3900.143H	58,63	
20708110	20.3900.510H	58,59,63	
20708230	20.3900.520H	58,59,63	
20708303	59.3900.233H	58,63	
20743983	59.3900.243H	58,63	
20849837	59.5524.648.099	59,63	
20854088	20.2480.211H	81	
20854564	15.3702.470H	62	
20854568	15.3712.410H	--	
20854576	40.2520.422H	62	
20854583	40.3605.204F	62	
20862779	11.3900.200H	58,63	
20862782	61.3900.100H	58,59,63	
20862795	15.3900.840H	58,59,63	
20862800	11.3910.200H	58,63	
20862809	61.3911.110H	58,63	
20862810	15.3911.871H	58,63	
20862812	08.5752.024.099	41,42,58,59,63	
20862813	61.3911.120H	58,63	
20862815	15.3911.872H	58,63	
20866665	61.3900.110H	58,59,63	
20866672	08.5752.024.099	41,42,58,59,63	
20903722	58.3900.143H	58,59,63	
20903723	58.3900.133H	58,63	
20903727	58.3900.143H	58,59,63	

OE			
Volvo			
20903732	58.3900.233H	58,63	
20925244	08.3200.233H	41,42,76,79,80	
20970652	51.3850.197H	70	
20970794	61.3000.002.001	71	
21020285	51.5524.930H	59,63,71	
21070768	15.2242.870H	--	
21083501	56.2600.147H	26	
21083541	09.2070.101H	26,28,44,62,72,80	
21150393	55.2561.110	--	
21203313	59.3601.178H	62	
21310517	51.2480.150H	--	
21314080	55.3000.117	--	
21320365	15.2242.870H	--	
21320383	15.2240.840H	64	
21326526	59.3900.233H	58,63	
21326527	59.3900.243H	58,63	
21386593	15.2712.113F	77	
21462625	58.2704.065	--	
21475603	59.3900.233H	58,63	
21614025	09.3900.003.000	58,59,63	
21618499	08.5752.024.099	41,42,58,59,63	
21879369	59.2910.001.001	78	
21879404	59.2910.004.001	78	
21885961 / 22117455	61.2910.002.001	79	
21885962	61.2910.005.001	79	
21885963	61.2910.006.001	79	
21885964	61.2910.003.001	79	
21885965	61.2910.008.001	79	
21894545	59.2910.002.001	78	
21922258	59.2910.005.001	78	
22026461	20.2710.650	41	
22026977	59.2910.008.001	78	
22033845	12.1018.001.099	76	
22033846	12.1018.002.099	76	
22033847	15.2780.840	41,43,79	
22033849	19.1018.314.000	--	
22038103	09.2910.002.099	76,79	

Cross-reference-table Vergleichsliste nach OE-Nummern

OE		
Volvo		
22544279	59.2910.024.001	--
22648216	61.2910.004.001	79
22836792	59.2910.007.001	78
22838596	59.2760.007.001	--
22847902	51.3635.206	72
22847915	11.3730.210H	18,40,72,77
22847920	15.3802.840H	72
23120356	58.2706.104H	--
23200690	51.7504.044.001	71
23227102	61.1000.004.099	65
23238988	20.2710.121	77
23286290	20.7504.044.001	71
23286294	20.7504.003.001	71
23329006	59.2910.006.001	78
23614948	20.2760.140	--
23614972	20.2760.150	--
23655694	09.2710.200	--
23946968	59.2910.014.001	78
23946969	59.2910.013.001	78
24015370	19.1000.121.099	65
24015373	19.1000.122.099	65
24018790	51.3000.002.001	--
24018822	61.3000.004.010	71
2739166	11.2770.920	42
3090395	51.2520.127H	62
3090734	40.3605.204F	62
3090737	15.3702.470H	62
3090739	15.3712.410H	--
3091756	15.3702.470H	62
3091757	15.3712.410H	--
3092854	15.3702.470H	62
3093944	59.2715.101.099	--
3093945	59.2715.102	--
3098470	40.3640.422H	26,28
3126117	59.3602.128H	62
5.899.90.057.81	40.3640.422H	26,28
5.899.90.058.03	51.2540.128	--
52510003	56.2630.127	--
589990057800	51.3410.147H	26
589990057960	51.2540.148	--
5899900579601	40.2540.422H	44
592710409	59.2710.409	--
6795142	51.2520.177	--
703060536	15.2712.113F	77
70309620	58.2705.001H	83
70309627	51.3731.326	40,77
70309630	58.2704.059	--
70310107	56.2630.127	--
70310110	11.1523.212	--
70328278	59.2710.401H	77
70328289	59.2710.406	77
70328290	20.2710.121	77
70328291	59.2706.104H	--
70328294	58.2704.070	83
70331012	15.2712.114	40,77
70331060	58.2704.044	83
70331062	51.1524.117	--
70331063	51.2500.167H	--
70331119	20.2700.240	--
70331120	20.2700.230	--
70331122	20.2710.111H	77
70331123	20.2480.217H	40,52,77,81
7033112370348002	20.2480.217H	40,52,77,81
70331124	20.2480.216H	40,52,77,81
70331940	59.2762.322	40
70331941	20.2710.620	40,41,81
70332172	58.2704.078	--
70348000	59.2715.101.099	--
70348001	59.2715.102	--
70348002	20.2480.216H	40,52,77,81
70348003	20.2480.216H	40,52,77,81
70348066	09.3200.220	90
70352000	58.2705.003	83
70352646	20.2480.210H	81
70360528	20.2710.132D	--
70360529	20.2480.222	--
70360530	20.2710.200H	40,77
70360531	58.2710.101	--
70360533	11.3730.210H	18,40,72,77
70360534	20.2710.142D	--
70360538	08.3491.325.000	--
70369682	51.3732.326	40,77
73028283	59.2710.402H	77
82356808	13.1043.001.000	65
82356810	19.1000.101.099	65
82356824	19.1000.103.099	65
82359213	13.1043.001.000	65
82359214	19.1000.102.099	65
82417041	40.5725.412H	29,64
82417042	11.5721.001.099	29,64
82417044	40.5735.403H	29,64
82417045	11.5731.001.099	29,64
82471688	61.5721.005.099	64
82471689	61.5731.001.099	--
82471690	61.5721.006.099	64
82472612	61.5721.004.099	29,64
8350002289	09.2070.101H	26,28,44,62,72,80

OE		
Volvo		
8350026023	09.3400.440	--
8350035653	51.3731.326	40,77
8350035654	51.3732.326	40,77
8350035655	09.3200.220	80
8350042502	59.2710.401H	77
8350045482	20.2700.240	--
8350045484	20.2700.230	--
8350046432	20.2480.217H	40,52,77,81
8350046433	20.2710.200H	40,77
8350046555	11.3730.210H	18,40,72,77
8350046557	15.2712.114	40,77
8350046970	20.2710.111H	77
8350046971	20.2480.216H	40,52,77,81
8350046556	15.2711.114	40,77
84531138	59.1025.001.099	21,60,64
84531168	59.1025.002.099	21,60,64
85104654	20.2700.260	--
85104656	20.2700.200H	40,77
85120820	61.3900.130H	58,59,63
8690002311	40.3005.222	--
8706271900014	59.2715.101.099	--
70348000	59.2715.101.099	--
8706271900015	59.2715.102	--
8706271900018	20.2480.217H	40,52,77,81
8706271900020	20.2710.111H	77
8706271900021	09.3200.220	80
8706271900030	15.3731.470H	18,40,77
8706271900031	59.2705.000	--
8706271900052	11.3730.210H	18,40,72,77
8706271900058	58.2704.059	--
8706271900059	51.3731.326	40,77
8706271900060	51.3732.326	40,77
8706271900055	20.2480.210H	81
8706331900007	56.3491.110H	53,65
8706331900008	56.3492.110H	53,65
VW		
2D0 857 537 C	11.3491.200	--
2D0 959 577	08.3491.313.000	--
2D3 857 501 D	59.3496.110V	--
2D0857521	15.3491.071H	53,65
2D0857521A	15.3491.371H	53,65
2D0857522	15.3491.072H	53,65
2D0857522A	15.3491.372H	53,65
2D1857501A01C	51.3495.110H	--
2D1857501C01C	51.3495.112H	65
2D1857502A01C	51.3495.120H	--
2D1857502C01C	51.3495.122H	65
2E0857513B	51.5894.310.199	54
2E0857513C	51.5894.112.199	--
2E0857514A	51.5894.410.199	54,66
2E0857514B	51.5894.212.199	--
2E0857527	13.5890.120.099	55,57,67
2E0857528	13.5890.220.099	55,57,67
2E0857587A	19.5890.011.099	55,57,67
2E0857587B	19.5891.011.099	55,67
2E0857588B	19.5891.012.099	55,67
2E0919473	08.5890.300.099	55,67
2E0919473A	08.5890.301.099	55,67
2E0945981	08.5892.105.099	55,57,67
2E0950050A	08.5892.003.099	55,57,67
2E0953049A	08.5892.001.099	55,67
2E0953049B	08.5892.004.099	55,67
2E0953049C	08.5892.002.099	55,57,67
2E0953050A	08.5892.004.099	55,67
2E0953050C	08.5892.003.099	55,57,67
2E1857136	14.5890.100.099	55,57,67
2E1857136A	14.5890.200.099	55,57,67
2E1857501AJ	51.5891.111.199	54,66
2E1857501AK	51.5892.111.199	54,66
2E1857501AL	51.5893.111.199	54,66
2E1857501E	51.5891.111.199	54,66
2E1857501F	51.5891.113.199	54,66
2E1857501Q	51.5891.112.199	--
2E1857501R	51.5892.112.199	--
2E1857502AK	51.5891.211.199	54,66
2E1857502AL	51.5892.211.199	54,66
2E1857502AM	51.5893.211.199	54,66
2E1857502D	51.5892.211.199	54,66
2E1857502E	51.5891.211.199	54,66
2E1857502F	51.5891.213.199	54,66
2E1857502P	51.5891.212.199	--
2E1857502Q	51.5892.212.199	--
2E1857516A	13.5890.110.199	55,57,67
2E1857516B	13.5890.210.199	55,57,67
2E1857587	15.5891.741H	55,67
2E1857587A	15.5891.611H	55,67
2E1857587E	15.5891.721.099	55,57,67
2E1857588	15.5891.742H	55,67
2E1857588A	15.5891.612H	55,67
2E1857588E	15.5891.722.099	55,57,67
2E2857501C	51.5891.311.199	54,66
2E2857501D	51.5891.313.199	54,66
2E2857501F	51.5891.312.199	--
2E2857501G	51.5892.312.199	--
2E2857501N	51.5891.311.199	54,66
2E2857502C	51.5891.411.199	54,66

OE		
Wirtgen		
2186303	51.1009.001.099	73
2499855	58.1016.004.099	82
2499856	58.1016.003.099	82
Wrightbus		
MIR-00196	51.3731.326	40,77
MIR-00215	59.2706.302	--
MIR-00235	09.3200.360	--
MIR-00246	20.2710.600	--
MIR-00258	20.2710.520	40,41,81
MIR-00329	59.3601.128H	62
MIR-00337	08.3492.324.099	--
MIR-00515	08.3491.325.000	--
RW MIR-00265	20.2710.630	--
RW MIR-00266	09.3200.220	80

DAF

65 CF, 75 CF,
85 CF, 95 XF
alternativ 75 / 85 / 95
03/00 - 04/06
09/92



373	II [e1] 02★0423 II (E1) 010423			Ø 28 mm
------------	-----------------------------------	--	--	---------

MEKRA LANG Group	Beschreibung description descripção descriziune beniämning popis omivcawne özellik leirats opis						mm	OE
	Icon 1	Icon 2	Icon 3	Icon 4	Icon 5	Icon 6		
61.3730.324H							384 x 205 x 120	1425 104 ♦ 1610 186
15.3731.470H							369 x 190 x 42	1425 109 ♦ 1610 190
11.3730.210H							367 x 187 x 60	1425 113
61.3730.326H							384 x 205 x 120	1425 105 ♦ 1610 184
15.3731.470H							369 x 190 x 42	1425 109 ♦ 1610 190
11.3730.210H							367 x 187 x 60	1425 113

386 386-1	IV [e1] 02★0424 IV (E1) 010424 IV [e1] 03★0023			Ø 28 mm
----------------------------	--	--	--	---------

MEKRA LANG Group	Beschreibung description descripção descriziune beniämning popis omivcawne özellik leirats opis						mm	OE
	Icon 1	Icon 2	Icon 3	Icon 4	Icon 5	Icon 6		
61.3860.214H							219 x 170 x 120	1425 108 ♦ 1610 187
15.3861.114H							203 x 154 x 36	1425 111 ♦ 1610 191
11.3860.500H							203 x 154 x 60	1425 114
61.3865.124H							219 x 170 x 120	1610 189
15.3862.174H							203 x 154 x 36	1610 182
11.3860.500H							203 x 154 x 60	1425 114

































906	IV [e1] 03★0014			Ø 28 mm
------------	-----------------	--	--	---------

MEKRA LANG Group	Beschreibung description descripção descriziune beniämning popis omivcawne özellik leirats opis						mm	OE
	Icon 1	Icon 2	Icon 3	Icon 4	Icon 5	Icon 6		
61.9065.114H							209 x 218 x 136	1670 877
15.9060.870H							204 x 195 x 58	1670 878
11.9060.100H							202 x 194 x 55	1670 888
56.9065.110							209 x 218 x 136	
15.9060.870H							204 x 195 x 58	1670 878
11.9060.100H							202 x 194 x 55	1670 888
61.3860.100							210 x 9ø	

DAF



















03/00 - 05/06

DAF

348	II  03★0184 II  021022	 	Ø 22 mm
	Beschreibung description description description benámening Popis özellik leirás opis		OE
61.3481.149H	      1	395 x 205 x 145	1805 714
15.3480.840H	      	372 x 189 x 32	1805 717
11.3480.100		169 x 88 x 27	
61.3480.149H	      2	382 x 193 x 85	1405 295 ♦ 1805 712 1404 871
40.3485.412H	      	375 x 190 x 3	1805 713

LF 45/55



348	IV  03★0185 IV  021023	 	Ø 22 mm
	Beschreibung description description description benámening Popis özellik leirás opis		OE
61.3482.149H	     	199 x 199 x 97	1796 324 ♦ 1404 868 1405 350
40.3485.403H	      	191 x 191 x 3	1796 325 ♦ 1404 849



XF 95, XF 105, XF 106
CF 65/75/85
JOHN DEERE

01/06
05/06
10/11



XF 95, XF 105, XF 106

02/13

DAF

570	II e1 03★0007		ABS	Ø 40 mm
	II E1 02 1251			
		mm		OE
61.5700.210H		411 x 228 x 140	1692 557	
61.5700.310.099		411 x 228 x 140	1812 862 + 1689 348	
15.5701.840H		363 x 177 x 25	1685 330 AL 20 31 51 (John Deere)	
11.5700.100H		411 x 228 x 110	1644 325	
09.5700.001.099		250 x 6 ø		

571 574	IV e1 03★0008		ABS	Ø 40 mm
	IV E1 02 1252			
		mm		OE
EURO 5	61.5710.210H		239 x 221 x 140	1692 556
	61.5710.310.099		239 x 221 x 140	1817 860 + 1689 347
	15.5711.870H		207 x 161 x 35	1685 331
	11.5710.110H		239 x 221 x 118	1644 326 + 1659249
	09.5700.002.099		250 x 6 ø	1812 865
	61.5710.310.099		239 x 221 x 140	1817 860 + 1689 347
	15.5711.870H		207 x 161 x 35	1685 331
	11.5710.110H		239 x 221 x 118	1644 326 + 1659249
	61.5740.001.099		245 x 243 x 140	1940 341
	19.5740.311.099		211 x 192 x 40	1940 342
12.5740.002.099		245 x 240 x 118	1882 113	

XF 95, XF 105, XF 106

11/09
11/09



559	VI E1 021039		ABS	INTEGR.
	VI e1 03★0196			
		mm		OE
XF	59.5595.235H		411 x 375 x 285	1684 042 + 1816 912
	59.5595.236		411 x 375 x 285	1684 043 + 1816 913
XF	59.5595.331H		1007 x 320 x 220	1684 046 + 1816 914
	59.5595.332		1007 x 320 x 220	1684 047 + 1816 915
CF	59.5595.131H		437 x 433 x 383	1684 030 + 1816 902
	59.5595.132H		437 x 433 x 383	1684 031 + 1816 903
	61.5590.001.099		256 x 165 x 82	1830 338
	20.5521.100H		110 x 53 x 51	1698 180

DAF

570 A		ALU		Ø 40 mm	
MEKRA LANG Group		Beschreibung description descripção descrizione benamning popis описанье leirás opis		mm	
		OE			
58.5701.104.099		818 x 40 ø	1685 324 ♦ 1812 867	XF	EURO 5
58.5700.001.099		818 x 40 ø	1685 325 ♦ 1830 562		
58.5700.003.002		818 x 40 ø	1940334	EURO 6	
58.5700.004.002		818 x 40 ø	1940335		
58.5713.114.099		920 x 40 ø	1788 972 ♦ 1812 859	CF	
58.5710.001.099		920 x 40 ø	1788 487 ♦ 1818 353		
20.5700.410H		145 x 98 x 68	1644 324	XF	EURO 5
20.5700.420H		145 x 98 x 68	1644 323		
12.5700.001.099		304 x 113 x 82	1882 126	XF	EURO 6
12.5700.002.099		205 x 78 x 45	1882 111		
12.5700.003.099		304 x 113 x 82	1882 127		
12.5700.004.099		205 x 78 x 45	1882 112		



XF 95, XF 105, XF 106
CF 65/75/85
01/06
05/06

552 552-1		V e1 02★0742 V VI e1 03★0033 V VI (E) 020894		Truck ABS	
MEKRA LANG Group		Beschreibung description descripção descrizione benamning popis описанье leirás opis		mm	
		OE			
59.5520.230H		319 x 187 x 50	1669 573	XF	
59.5520.130H		319 x 187 x 50		CF	



1005		V e1 04★1336 V (E) 041336		Truck ABS	
MEKRA LANG Group		Beschreibung description descripção descrizione benamning popis описанье leirás opis		mm	
		OE			
59.1005.001.099		326 x 202 x 214	1949 304	CF	
59.1005.002.099		326 x 202 x 214	1949 305	XF	

New Regulation ECE R46/04



1025		V e1 04★1345		Truck ABS	
MEKRA LANG Group		Beschreibung description descripção descrizione benamning popis описанье leirás opis		mm	
		OE			
59.1025.001.099		315 x 179 x 220	1709 390	LF	
59.1025.002.099		315 x 179 x 220	1709 389		

LF 45/55

New Regulation ECE R46/04



*XD/XF/XG/XG+
New Generation*

10/2020



DAF

1027	NEW	II (E1) 041619 IV (E1) 041620			INTEGR.
-------------	------------	----------------------------------	--	--	----------------

Beschreibung
description
description
description
description
bezeichnung
popis
omrečnice
drüelikk
reirags
opis

mm

OE

LHD	59.1027.001.099		1014 x 397 x 200	2248 157	
	59.1027.002.099		1014 x 414 x 258	2248 158	
	RHD	59.1027.003.099		1014 x 414 x 258	2248 175 + 2352 946
		59.1027.004.099		1014 x 397 x 200	2248 176
a	12.1027.005.099	für für pour main mirror	1 701 x 248 x 154	2248 166	
	12.1027.107.099	für für pour main mirror	2 701 x 248 x 154	2248 172	
	12.1027.207.099	für für pour main mirror	3 701 x 248 x 154	2298 826	
	12.1027.006.099	für für pour main mirror	4 701 x 248 x 154	2248 167	
	12.1027.108.099	für für pour main mirror	5 701 x 248 x 154	2248 173	
	12.1027.208.099	für für pour main mirror	6 701 x 248 x 154	2298 827	
b	12.1027.001.099	für für pour upper foot	7 205 x 103 x 98	2248 164	
	12.1027.002.099	für für pour upper foot	8 205 x 103 x 98	2248 165	
c	12.1027.103.099	für für pour lower foot	9 266 x 177 x 114	2248 160	
	12.1027.203.099	für für pour lower foot	10 266 x 177 x 114	2298 758	
	12.1027.104.099	für für pour lower foot	11 266 x 177 x 114	2248 161	
	12.1027.204.099	für für pour lower foot	12 266 x 177 x 114	2298 759	
d	19.1027.011.099	1200 24 V	13 384 x 200 x 42	2306 590	
	19.1027.012.099	1200 24 V	14 384 x 200 x 42	2306 591	
	19.1027.311.099	300 24 V	15 209 x 210 x 52	2306 592	
	19.1027.312.099	300 24 V	16 209 x 210 x 52	2306 593	
	12.1027.015.099	für für pour neck	17 176 x 164 x 79	2248 168	
	12.1027.016.099	für für pour neck	18 176 x 164 x 79	2248 169	
	61.1029.224.099	für für pour	19 130 x 125 x 50	2306 586	
	61.1024.224.099	für für pour	20 130 x 125 x 50	2306 587	

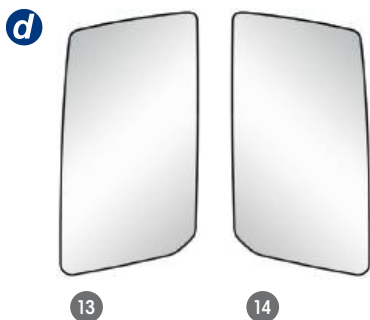

DAF

559	NEW	VI (E1) 021039			INTEGR.	
		VI (e1) 03★0196				
		Beschreibung description descripción descrizione beskrivning oíríscríobán optiskaine optisk optis		mm	OE	
59.5590.013.099					450 x 491 x 217	2248 178 ♦ 2346 204 ♦ 2415 378
59.5590.014.099					450 x 491 x 217	2248 179 ♦ 2346 205 ♦ 2415 379
12.5590.009.099					① 209 x 128 x 70	2248 184

*XD/ XF / XG / XG+
New Generation*

10/2020 →



1005	NEW	V (e1) 04★1336				
		V (E) 041336				
		Beschreibung description descripción descrizione beskrivning oíríscríobán optiskaine optisk optis		mm	OE	
59.1005.011.099					330 x 233 x 205	2248 159
12.1005.001.099					② 121 x 78 x 52	2248 174

*XD/ XF / XG / XG+
New Generation*

10/2020 →



IVECO

Stralis
Trakker
Eurocargo
Tector

04/06
04/06
04/06
04/06



IVECO

1008		II e3 03★1034 IV e3 03★1036		Truck	ABS	INTEGR.
MEKRA LANG Group		Beschreibung description descripção descripziõe benamning popis omivkaue üzellik opis		mm		OE
59.1008.005.099		799 x 370 x 272	504 150 526 + 504 369 910 580 133 4614			
59.1008.006.099		799 x 370 x 272	504 150 527 + 504 369 961 580 133 4610			
59.1008.045H*		799 x 370 x 272	504 150 532			
59.1008.046H*		799 x 370 x 272	504 150 533			
59.1008.011.099		799 x 424 x 287	504 150 538 + 504 370 048 580 133 6285			
59.1008.012.099		799 x 424 x 287	504 150 539 + 504 370 055 580 133 6298			
59.1008.051H*		799 x 424 x 287	504 150 544			
59.1008.052H*		799 x 424 x 287	504 150 545			
59.1008.017.099		811 x 520 x 304	504 150 551 + 504 369 979 580 134 1206			
59.1008.018.099		811 x 520 x 304	504 150 552 + 504 369 995 580 134 1207			
59.1008.057H*		811 x 520 x 304	504 150 557			
59.1008.058H*		811 x 520 x 304	504 150 558			
19.1008.041.099		371 x 181 x 15	504 197 878			
19.1008.311.099		192 x 206 x 20	504 197 879			

* only available in UK/IRL



1008		V e3 03★1031		Truck	ABS	
MEKRA LANG Group		Beschreibung description descripção descripziõe benamning popis omivkaue üzellik opis		mm		OE
56.1008.002.099		270 x 230 x 60	504 168 236			
56.1008.003.099*		270 x 230 x 60	504 168 237			
56.1008.004.099*		270 x 230 x 60	504 168 238			
11.1008.001.099		210 x 205 x 100	504 168 244			

* only available in UK/IRL

IVECO

1008	VI e3 03★1042			INTEGR.
	Beschreibung description descripção descrizione benámenning popis onycauwe őzeilijk leírás opis		mm	OE
55.1008.002.099		315 x 240 x 60	504 224 428	
55.1008.003.099*		315 x 240 x 60	504 224 429	
55.1008.004.099*		315 x 240 x 60	504 224 430	

* only available in UK/IRL

Stralis
Trakker
Eurocargo
Tector



IVECO

04/06 - 2019
04/06
04/06
04/06

279	NEW	II e4 04★11854 IV e4 04★11853 V e4 04★11687 V e4 04★11688			INTEGR.
	Beschreibung description descripção descrizione benámenning popis onycauwe őzeilijk leírás opis		mm	OE	
19.2790.011.099		399 x 222	500 086 749	a	
19.2790.012.099		399 x 222	500 086 750	a	
19.2790.031.099		223 x 218	500 086 753	b	
19.2790.032.099		223 x 218	500 086 754	b	
11.2790.001.099		640 x 240 x 108	580 249 8968	c	
11.2790.002.099		640 x 240 x 108	580 249 8969	c	

S-Way, T-Way



2020

MAN

M 90, F 90

03/00



320	II [e1] 02★14054 II [e1] 02★14053 II (E1) 0114053	II		Ø 18-30 mm
	Beschreibung description descripção descripziune benamning popis оригинале leírás opis		mm	OE
51.3200.147H		380 x 190 x 100	81.63730-6193	
40.3200.422H		366 x 176 x 3	81.63733-0036	
09.3200.420H		42 x 42 x 54 [2000]	88.25505-0024	

M 90, F 90

08/88 - 09/94



340 341	II [e1] 02★14098 II (E1) 0114098	II		① Ø 14-20 mm ② Ø 20-30 mm
	Beschreibung description descripção descripziune benamning popis оригинале leírás opis		mm	OE
51.3410.127H		377 x 189 x 65	81.63730-6233 + 81.63730-6220	
51.3412.120H		377 x 189 x 65	81.63730-6420	
40.3640.222H		363 x 175 x 3	81.63733-0025 + 81.63733-0030 81.63733-0060	
51.3410.147H		377 x 189 x 65	81.63730-6234 + 81.63730-6221 81.62730-6221	
51.3410.140		377 x 189 x 65		
40.3640.422H		363 x 175 x 3	81.63733-0064 + 81.63733-6003 81.63730-0032 + 81.63730-6003 81.63730-6202 + 85.20000-9601	
10.6121.100		340 x 159		
09.2000.301H		2000 x 9ø	83.25402-6010	
51.3400.147H		377 x 189 x 65	88.63730-6041 + 85.63730-6015 81.63730-6016	
40.3640.422H		363 x 175 x 3	81.63733-0064 + 81.63733-6003 81.63730-0032 + 81.63730-6003 81.63730-6202 + 85.20000-9601	
09.3400.420		42 x 42 x 54 [2000]		

M 90, F 90

07/88



260	IV [e1] 02★11001	IV		Ø 14-20 mm
	Beschreibung description descripção descripziune benamning popis оригинале leírás opis		mm	OE
56.2600.127H		205 x 158 x 70	81.63730-6206	
40.2605.204H		190 x 143 x 3	81.63733-0042	
56.2600.147H		205 x 158 x 70		
40.2605.204H		190 x 143 x 3	81.63733-0042	
10.6321.100		186 x 130		
09.2070.101H		2070 x 9ø	81.25432-0149	

MAN

266 266-1	IV V 02★11008			① Ø 14-20 mm
	IV V 0111008			② Ø 20-30 mm
	IV V 0211008			

MEKRA LANG Group	Beschreibung description descripção descrizione description benamning popis описание skaidis leirás opis	mm	OE
56.2660.127H	①	214 x 164 x 55	81.63730-6235 + 81.63730-6222
56.2662.120H	②	214 x 164 x 55	81.63730-6421
40.2665.204H	400	200 x 150 x 3	81.63733-0061
56.2660.147H	①	214 x 164 x 55	81.63730-6236 + 81.63730-6223 81.63730-6299
40.2660.404H	400	200 x 150 x 3	81.63733-6007
10.6321.100	24V 15W	186 x 130	
09.2000.301H		2000 x 9ø	83.25402-6010
56.2660.001.099	①	214 x 164 x 60	
56.2660.004.099	①	214 x 164 x 60	
40.2665.203H	300	200 x 150 x 3	
56.2660.002.099	②	214 x 164 x 60	81.63730-6754
40.2665.403H	300	200 x 150 x 3	
10.6321.100	24V 15W	186 x 130	
09.2000.301H		2000 x 9ø	83.25402-6010

265	V 02★12007			① Ø 10 mm
	V 0112007			②

MEKRA LANG Group	Beschreibung description descripção descrizione description benamning popis описание skaidis leirás opis	mm	OE
56.2650.121H	①	247 x 157 x 63	81.63730-6224
59.2652.110H	②	247 x 157 x 63	81.63730-6237

365-1	V VI 03★0015			
	V VI 020922			
	V VI 02★12015			
	V VI 0112015			

MEKRA LANG Group	Beschreibung description descripção descrizione description benamning popis описание skaidis leirás opis	mm	OE
59.3652.128H		324 x 184 x 98	82.63730-6033 + 81.63730-6294
15.3946.670F	300	324 x 184 x 61	81.63733-0099
59.3652.148H	24V	324 x 184 x 98	82.63730-6034
59.3652.168H	24V	324 x 184 x 85	82.63730-6035

08/88 - 09/94

M 90, F 90



MAN

M 90, F 90
G 90



08/88 - 09/94
09/87 - 05/95

08/88 - 09/94
09/87 - 05/95

M 90, F 90
G 90
F 2000, L 2000
M 2000
TG-L, TG-M

09/94
09/97
06/05



MAN / VW G 90 (6-9 t) 10/75 - 07/88



MAN

251		II e1 01★14050		Truck II	ABS	Ø 14-20 mm
MEKRA LANG Group		Beschreibung description descripción descricao description benämning pops описанье özellik leirás opis		mm		OE
51.2510.127H		318 x 186 x 26	81.63730-6167 + 81.63730-6127			
40.2510.222H		308 x 176 x 3	81.63733-0032			
51.2510.137H		318 x 186 x 26				
40.2510.322H		308 x 176 x 3				
10.6211.100		282 x 162				
09.2070.101H		2070 x 9ø	81.25432-0149			
51.2510.147H		318 x 186 x 26	81.63730-6128 + 81.63730-6148			
40.2510.422H		308 x 176 x 3				
10.6221.100		282 x 162				
09.2070.101H		2070 x 9ø	81.25432-0149			

10/75 - 07/88

F8, F9



364		II e1 02★14082 II (E1) 0114082		Truck II	ABS	Ø 14-20 mm
MEKRA LANG Group		Beschreibung description descripción descricao description benämning pops описанье özellik leirás opis		mm		OE
51.3640.127H		376 x 187 x 28	81.63730-6108 + 81.63730-6126 81.63730-6149 + 81.63730-6147 81.63730-6148 + 81.63730-6194			
40.3640.222H		363 x 175 x 3	81.63733-0025 + 81.63733-0030 81.63733-0060			
51.3640.137H		376 x 187 x 28				
40.3640.322H		363 x 175 x 3				
10.6111.100		340 x 159				
09.2070.101H		2070 x 9ø	81.25432-0149			
51.3640.147H		376 x 187 x 28	81.63730-6151 + 81.63730-6001			
40.3640.422H		363 x 175 x 3	81.63733-0064 + 81.63733-6003 81.63730-0032 + 81.63730-6003 81.63730-6202 + 85.20000-9601			
10.6121.100		340 x 159				
09.2070.101H		2070 x 9ø	81.25432-0149			

MAN

572	II 03★0031 II 020918		Ø (18) / 22 / 28 mm
	Beschreibung description descripção descrizione benamning Popis описанье özellik leirás opis		OE
51.5720.120H		426 x 200 x 135	85.63730-6030
40.5725.212H		412 x 188 x 3	81.63733-0101
51.5720.140H		426 x 200 x 135	85.63730-6033
40.5725.412H		412 x 188 x 3	81.63733-0103
51.5721.160H		426 x 200 x 135	85.63730-6035
51.5722.160H		426 x 200 x 135	85.63730-6036
40.5725.412H		412 x 188 x 3	81.63733-0103
61.5721.004.099		78 x 69 x 38	
11.5721.001.099		426 x 199 x 36	
11.3860.700		100 x 22 ø → 18 ø	

06/2005 →
06/2005 →

TGL, TGM (TGA)
L 2000, M 2000



MAN

573	IV 03★0032 IV 020917		Ø (18) / 22 / 28 mm
	Beschreibung description descripção descrizione benamning Popis описанье özellik leirás opis		OE
56.5730.120H		202 x 198 x 126	85.63730-6037
40.5735.203H		190 x 184 x 3	81.63733-0104
56.5730.140H		202 x 198 x 126	85.63730-6039
40.5735.403H		190 x 184 x 3	81.63733-0106
61.5721.004.099		78 x 69 x 38	
11.5731.001.099		202 x 198 x 27	
11.3860.700		100 x 22 ø → 18 ø	



579	V 03★0109 V 021179		
	Beschreibung description descripção descrizione benamning Popis описанье özellik leirás opis		OE
56.5790.003.099		303 x 163 x 88	81.63730-6734 + 81.63730-6574
15.5791.570.099		303 x 163 x 55	81.63733-6078
56.5790.004.099		303 x 163 x 88	81.63730-6733 + 81.63730-6573
15.5791.470H		303 x 163 x 55	81.63733-6074



F 2000, L 2000
M 2000
09/94 - 03/00
09/97 - 03/00

MAN

373		II 02★0524 II 010524	II		Ø (18) / 22 mm
MEKRA LANG Group		Beschreibung description descripção descripziõe benämning popis описување írírás opis			OE
51.3735.121H		384 x 205 x 120	81.63730-6314 ♦ 81.63730-6331		
51.3736.121H		384 x 205 x 120	81.63730-6303 ♦ 81.63730-6332		
51.3735.124H		384 x 205 x 120	81.63730-6315 ♦ 81.63730-6365 81.63730-6361		
51.3736.124H		384 x 205 x 120	81.63730-6304 ♦ 81.63730-6366 81.63730-6362 ♦ 81.63732-0046		
51.3731.325		384 x 205 x 120			
51.3732.325		384 x 205 x 120			
51.3735.126H		384 x 205 x 120	81.63730-6316 ♦ 81.63730-6367 81.63730-6363 ♦ 81.63732-0051		
51.3736.126H		384 x 205 x 120	81.63730-6305 ♦ 81.63730-6368 81.63730-6364 ♦ 81.63732-0047		
15.3731.070H		369 x 190 x 42	81.63733-0066 ♦ 81.63730-0066		
15.3731.373		369 x 190 x 42			
15.3731.074H		369 x 190 x 42	81.63733-0067 ♦ 81.63733-0075 81.63730-0067		
11.3730.310H		367 x 187 x 60			
11.3860.700		100 x 22 ø -> 18 ø			



MAN

386		IV 02★0424 IV 010424	IV		Ø (18) / 22 mm
MEKRA LANG Group		Beschreibung description descripção descripziõe benämning popis описување írírás opis			OE
56.3860.112H		219 x 170 x 120	81.63730-6306		
56.3860.114H		219 x 170 x 120	81.63730-6307 ♦ 81.63732-0050		
56.3861.116H		219 x 170 x 120	81.63730-6317 ♦ 81.63732-0049		
56.3862.116H		219 x 170 x 120	81.63730-6308 ♦ 81.63730-6328 81.63732-0048		
11.3860.300H		203 x 154 x 60			
11.3860.700		100 x 22 ø -> 18 ø			



MAN

380-1		II 03★0022 II 020905		Ø (18) / 22 mm
MEKRA LANG Group		Beschreibung description descripção descrizione benámenning Popis описання özellik leirats opis		OE
51.3801.148H		384 x 205 x 120	82.63730-6015	
51.3802.148H		384 x 205 x 120	82.63730-6016	
51.3801.168H		384 x 205 x 120	82.63730-6017	
51.3802.168H		384 x 205 x 120	82.63730-6018	
15.3802.840H		368 x 189 x 40	81.63733-0095	
11.3800.300H		374 x 196 x 40	81.63732-0044	
11.3860.700		100 x 22 ø -> 18 ø		

381-1		IV 03★0023 IV 021248		Ø (18) / 22 mm
MEKRA LANG Group		Beschreibung description descripção descrizione benámenning Popis описання özellik leirats opis		OE
56.3812.128H		219 x 170 x 120	82.63730-6022 * 82.63730-6021	
56.3812.148H		219 x 170 x 120	82.63730-6024 * 82.63730-6023	
56.3811.168H		219 x 170 x 120	82.63730-6025	
56.3812.168H		219 x 170 x 120	82.63730-6026	
15.3811.870H		203 x 154 x 36	81.63733-0097 * 81.63733-0098	
11.3810.340		209 x 160 x 40	81.63732-0078 * 81.63732-0045	
11.3860.700		100 x 22 ø -> 18 ø		

New Regulation
F 2000, L 2000
M 2000
2003/97/ECE
2007/38/ECE
09/94 - 03/00
09/97 - 03/00



MAN



MAN

F2000
TGA
TGL
TGM

09/94 - 03/00
03/00 →
2005 - 11/14
04/06 - 11/14



579	V e1 03★0109 V (E1) 021179	Truck	ABS	
MEKRA LANG Group	Beschreibung description descripción descripção descripção benámenning popis opniscawa úzeľník opis	mm	OE	
56.5790.003.099		303 x 163 x 88	81.63730-6734 * 81.63730-6574	
15.5791.570.099		303 x 163 x 55	81.63733-6078	
56.5790.004.099		303 x 163 x 88	81.63730-6733* 81.63730-6573	
15.5791.470H		303 x 163 x 55	81.63733-6074	

TGA
TGL
TGM

03/00 - 11/06
2005 - 11/06
04/06 - 11/06



392	II e1 02★0646 II (E1) 010646	Truck	ABS	Ø 28 mm
MEKRA LANG Group	Beschreibung description descripción descripção descripção benámenning popis opniscawa úzeľník opis	mm	OE	
51.3921.222H		399 x 207 x 137	81.63730-6395 * 81.63730-6345 81.63730-6430	
15.3921.870H		379 x 176 x 47	81.63733-0082 * 81.63733-6033	
51.3922.222H		399 x 222 x 138	81.63730-6399 * 81.63730-6347 81.63730-6432	
15.3922.870H		379 x 176 x 47	81.63733-0083 * 81.63733-6034	
11.3920.300H		57 x 23 x 30	81.63731-0286	
04.0603.007.000		30 x 6 Ø		
11.3921.110H		399 x 196 x 52	81.63732-0054 * 81.63732-0059 81.63732-0063	
11.3921.120H		399 x 210 x 52	81.63732-0055 * 81.63732-0060 81.63732-0064	

MAN

392-1	II e1 03★0024		ABS	Ø 28 mm
	II (E1) 02 0925			

MEKRA LANG Group	Beschreibung / description / descripción / descrizione / beňnaming / popis / описаније / breiðlik / leírás / opis				mm	OE
	Icon 1	Icon 2	Icon 3	Icon 4		
51.3921.224H					399 x 207 x 137	81.63730-6482
51.3923.224H					339 x 222 x 138	81.63730-6487
51.3921.223H					399 x 207 x 137	81.63730-6480
51.3923.223D					399 x 222 x 138	81.63730-6485
15.3920.840H					379 x 176 x 47	81.63733-6049
51.3922.224H					399 x 222 x 138	81.63730-6483
51.3924.224H					399 x 207 x 137	81.63730-6486
51.3922.223H					399 x 222 x 138	81.63730-6481
51.3924.223D					399 x 207 x 137	81.63730-6484
15.3920.840H					379 x 176 x 47	81.63733-6049
11.3921.400					117 x 62 x 9	81.63731-0309 + 81.63731-0366
04.0603.007.000					30 x 6 ø	
11.3921.110H					399 x 196 x 52	81.63732-0054 + 81.63732-0059 81.63732-0063
11.3921.120H					399 x 210 x 52	81.63732-0055 + 81.63732-0060 81.63732-0064

393-1	IV e1 03★0025		ABS	Ø 28 mm
	IV (E1) 02 0924			

MEKRA LANG Group	Beschreibung / description / descripción / descrizione / beňnaming / popis / описаније / breiðlik / leírás / opis				mm	OE
	Icon 1	Icon 2	Icon 3	Icon 4		
56.3931.343H					188 x 207 x 129	81.63730-6510
56.3931.323H					188 x 207 x 129	81.63730-6512
15.3932.870H					177 x 167 x 38	81.63733-6057
56.3932.343H					188 x 220 x 130	81.63730-6511
56.3932.323H					188 x 220 x 130	81.63730-6513
15.3932.870H					177 x 167 x 38	81.63733-6057
11.3921.400					117 x 62 x 9	81.63731-0309 + 81.63731-0366
04.0603.007.000					30 x 6 ø	
11.3931.110H					187 x 197 x 52	81.63732-0057 + 81.63732-0061 81.63732-0065
11.3931.120H					187 x 209 x 52	81.63732-0056 + 81.63732-0062 81.63732-0066

New Regulation
2003/97/ECE

12/06 →
12/06 - 11/14
12/06 - 11/14

TGA
TGL
TGM



New Regulation
2007/38/ECE

01/07 →
12/06 - 11/14
12/06 - 11/14

TGA
TGL
TGM



TGL Evolution
TGM Evolution
(Euro 6) 12/14
(Euro 6) 12/14

MAN

MAN

392-2	II [e1] 03★0024 II (E1) 02 0925			Ø 28 mm
--------------	------------------------------------	--	--	---------

	Beschreibung description descripção descripziune benamning popis omicaune özelliik leirás opis		OE
--	---	--	----

51.3920.002.099		24V	399 x 210 x 120	81.63730-6738
51.3920.004.099		24V	399 x 225 x 121	81.63730-6745
51.3920.001.099		24V	399 x 210 x 120	81.63730-6739
51.3920.014.099		24V	399 x 225 x 121	81.63730-6746
51.3920.003.099		24V	399 x 225 x 121	81.63730-6740
51.3920.005.099		24V	399 x 210 x 120	81.63730-6743
51.3920.013.099		24V	399 x 225 x 121	81.63730-6741
51.3920.012.099		24V	399 x 210 x 120	81.63730-6744
19.3920.011.099		24V 1200	379 x 176 x 34	81.63733-6079
12.3920.001.099			399 x 203 x 52	81.63732-0094
12.3920.002.099			399 x 208 x 53	81.63732-0095
11.3921.400		für pour 12/06	117 x 62 x 9	81.63731-0309 + 81.63731-0366
04.0603.007.000			30 x 6 ø	



393-2	IV [e1] 03★0025 IV (E1) 02 0924			Ø 28 mm
--------------	------------------------------------	--	--	---------

	Beschreibung description descripção descripziune benamning popis omicaune özelliik leirás opis		OE
--	---	--	----

56.3930.004.099		24V	187 x 210 x 127	81.63730-6748
56.3930.002.099		24V	187 x 210 x 127	81.63730-6749
56.3930.003.099		24V	188 x 223 x 128	81.63730-6750
56.3930.001.099		24V	188 x 223 x 128	81.63730-6751
19.3930.311.099		24V 300	177 x 167 x 35	81.63733-6080
12.3930.001.099			187 x 197 x 52	81.63732-0096
12.3930.002.099			187 x 209 x 52	81.63732-0097
11.3921.400		für pour 12/06	117 x 62 x 9	81.63731-0309 + 81.63731-0366
04.0603.007.000			30 x 6 ø	



579	V [e1] 03★0109 V (E1) 021179			
------------	---------------------------------	--	--	--

	Beschreibung description descripção descripziune benamning popis omicaune özelliik leirás opis		OE
--	---	--	----

56.5790.002.099		24V	303 x 163 x 88	81.63730-6735 + 81.63730-6578
15.5791.570.099		24V 300	303 x 163 x 55	81.63733-6078

MAN

580	II 03★0097			INTEGR.
	II 020929			
	IV 03★0098			
	IV 020930			

	Beschreibung description descripção descriptione benámenning popis описанье özellik leirás opis		OE

59.5800.101H		943 x 382 x 153	81.63730-6529	TGX
59.5800.102H		943 x 382 x 153	81.63730-6560 + 81.63730-6756	
59.5800.302H		943 x 382 x 153	81.63730-6563 + 81.63730-6767	
59.5800.201H		943 x 382 x 153	81.63730-6531	
59.5800.202H		943 x 382 x 153	81.63730-6561 + 81.63730-6765	
59.5800.203H		943 x 382 x 153	81.63730-6564 + 81.63730-6770	
59.5800.402H		943 x 382 x 153	81.63730-6562 + 81.63730-6758	

58.5800.101H		943 x 281 x 28 ø	81.63731-6638
58.5800.102H		943 x 281 x 28 ø	81.63731-6639

59.5800.121H		943 x 437 x 153	81.63730-6533	TGS
59.5800.122H		943 x 437 x 153	81.63730-6549 + 81.63730-6755	
59.5800.322H		943 x 437 x 153	81.63730-6552 + 81.63730-6764	
59.5800.221H		943 x 437 x 153	81.63730-6534	
59.5800.222H		943 x 437 x 153	81.63730-6550 + 81.63730-6762	
59.5800.223H		943 x 437 x 153	81.63730-6553 + 81.63730-6761	
59.5800.422H		943 x 437 x 153	81.63730-6551 + 81.63730-6757	

58.5800.201H		943 x 334 x 28 ø	81.63731-6640
58.5800.202H		943 x 334 x 28 ø	81.63731-6641

15.5801.840H		381 x 201 x 22	81.63733-6071
15.5811.871H		197 x 181 x 42	81.63733-6073
15.5811.872H		197 x 181 x 42	81.63733-6072

13.5800.100H		634 x 259 x 90	81.63732-0091
11.5800.100H		631 x 237 x 174	81.63731-0356
11.5800.200H		631 x 237 x 174	81.63731-0380

20.5800.410H		289 x 149 x 85	81.63732-0073
20.5800.420H		289 x 149 x 85	81.63732-0074
20.5800.610H		242 x 140 x 94	81.63732-0075
20.5800.620H		242 x 140 x 94	81.63732-0076
20.5800.710H		127 x 116 x 33	81.62410-0107
20.5800.720H		127 x 116 x 33	81.62410-0108
20.5800.750H		13 x 19 ø	81.63732-0090 + 81.62410-0109

579	V 03★0109			
	V 021179			

	Beschreibung description descripção descriptione benámenning popis описанье özellik leirás opis		OE

56.5790.002.099		303 x 163 x 88	81.63730-6735 + 81.63730-6578
15.5791.570.099		303 x 163 x 55	81.63733-6078

TGX / TGS
09/07 - 2021



TGX / TGS
01/2011



2020
2020
2020

TGX/TGS new
TGL new
TGM new

MAN

1024 **NEW** II (E1) 041543 IV (E1) 041542 ASA INTEGR.

Beschreibung description descripción descripción description benámenning popis omicaame бейлік лэйрас opis mm

MAN



L H D	59.1024.001.099		24 V	kurz short		936 x 355 x 206	81.63730-6859		
	59.1024.002.099		24 V	kurz short		936 x 355 x 206	81.63730-6860		
	59.1024.005.099		24 V	lang long		936 x 455 x 288	81.63730-6875		
	59.1024.006.099		24 V	lang long		936 x 455 x 288	81.63730-6874		
	59.1024.009.099		24 V	kurz short		936 x 355 x 206	81.63730-6853		
	59.1024.010.099		24 V	kurz short		936 x 355 x 206	81.63730-6854		
	59.1024.013.099		24 V	lang long		936 x 455 x 288	81.63730-6869		
	59.1024.014.099		24 V	lang long		936 x 455 x 288	81.63730-6868		
	59.1024.017.099		24 V	kurz short		936 x 355 x 206	81.63730-6865		
	59.1024.019.099		24 V	lang long		936 x 455 x 206	81.63730-6878		
R H D	59.1024.021.099		24 V	kurz short		936 x 355 x 206	81.63730-6863		
	59.1024.022.099		24 V	lang long		936 x 455 x 288	81.63730-6879		
	59.1024.023.099		24 V	kurz short		936 x 355 x 206	81.63730-6861		
	59.1024.024.099		24 V	kurz short		936 x 355 x 206	81.63730-6862		
	59.1024.025.099		24 V	lang long		936 x 455 x 288	81.63730-6877		
	59.1024.026.099		24 V	lang long		936 x 455 x 288	81.63730-6876		
	59.1024.027.099		24 V	kurz short		936 x 355 x 206	81.63730-6855		
	59.1024.028.099		24 V	kurz short		936 x 355 x 206	81.63730-6856		
	59.1024.029.099		24 V	lang long		936 x 455 x 288	81.63730-6871		
	59.1024.030.099		24 V	lang long		936 x 455 x 288	81.63730-6870		
19.1024.011.099		24 V		a	379 x 193 x 35	81.63733-6083			
19.1024.012.099		24 V		a	379 x 193 x 35	81.63733-6084			
19.1024.311.099		24 V		b	204 x 196 x 51	81.63733-6085			
19.1024.312.099		24 V		b	204 x 196 x 51	81.63733-6086			
13.1024.001.099					427 x 244 x 122	81.63732-0111			
13.1024.002.099					427 x 244 x 122	81.63732-0110			
13.1024.003.099		paintable			427 x 244 x 122	81.63732-0125			
13.1024.004.099		paintable			427 x 244 x 122	81.63732-0124			
12.1024.009.099		für for pour	foot cover top		241 x 137 x 105	81.63732-0115			
12.1024.010.099		für for pour	foot cover top		241 x 137 x 105	81.63732-0114			
12.1024.011.099		für for pour	foot cover bottom		215 x 148 x 100	81.63732-0113			
12.1024.012.099		für for pour	foot cover bottom		215 x 148 x 100	81.63732-0112			

MAN

1020	NEW	V (E1) 041389			INTEGR.
-------------	------------	---------------	--	--	---------

	Beschreibung description description description benamning popis описанье özellik leírás opis		mm	OE
--	--	--	----	----

56.1020.017.099			LIN-BUS	307 x 279 x 95	81.63730-6845
56.1020.018.099			LIN-BUS	307 x 279 x 95	81.63730-6846
56.1020.019.099			CAN-BUS	307 x 279 x 95	81.63730-6844
56.1020.020.099				307 x 279 x 95	81.63730-6843
56.1020.015.099				307 x 279 x 95	81.63730-6881
19.1020.213.099				297 x 172 x 62	81.63733-6087
19.1020.613.099				297 x 172 x 62	81.63733-6088
12.1020.003.099				191 x 137 x 41	81.63732-0106

2018



MAN TGX/TGS



MAN

2017

MAN

1013 **NEW** II (E1) 041427   INTEGR.

  mm 

TGE





















MAN



1



2

		Beschreibung description description description benamning pops omicaune bœreilk opis				
L H D	1	59.1013.116.199		384 x 330 x 257	7C1857387FP * 7C1857387ES 5, 14, 16, 20, 23, 24, 27 *	
		59.1013.117.199		384 x 330 x 257	7C1857387FJ * 7C1857387FC 1, 5, 12, 14, 16, 20, 23, 24, 25, 27 *	
		59.1013.216.199		384 x 309 x 314	7C1857388EG * 7C1857388DK 6, 15, 17, 21, 22, 24, 25, 29 *	
		59.1013.101.199		384 x 330 x 257	7C1857387FT * 7C1857387ET 4, 5, 14, 16, 18, 23, 27 *	
		59.1013.109.199		384 x 330 x 257	7C1857387FK * 7C1857387FD 1, 4, 5, 12, 14, 16, 18, 23, 27 *	
		59.1013.201.199		384 x 309 x 314	7C1857388EH * 7C1857388DL 4, 6, 15, 17, 19, 22, 25, 29 *	
		59.1013.212.199		384 x 309 x 314	7C1857388EC * 7C1857388DQ 2, 3, 4, 6, 13, 15, 17, 19, 22, 25, 29 *	
		59.1013.102.199		384 x 330 x 257	7C1857387FR * 7C1857387FB 4, 5, 14, 16, 18, 23, 26 *	
		59.1013.106.199		384 x 330 x 257	7C1857387FM * 7C1857387FF 1, 4, 5, 12, 14, 16, 18, 23, 26 *	
		59.1013.202.199		384 x 309 x 314	7C1857388EK * 7C1857388DN 4, 6, 15, 17, 19, 22, 25, 28 *	
	R H D		59.1013.316.199		384 x 309 x 314	7C2857387CR * 7C2857387CG 10, 14, 16, 20, 23, 24, 25, 30 *
			59.1013.317.199		384 x 309 x 314	7C2857387CN * 7C2857387CJ 1, 10, 12, 14, 16, 20, 23, 24, 25, 30*
			59.1013.416.199		384 x 330 x 257	7C2857388CB * 7C2857388BL 11, 15, 17, 21, 22, 24, 25, 31 *
			59.1013.301.199		384 x 309 x 314	7C2857387CS * 7C2857387CH 4, 10, 14, 16, 18, 23, 25, 30 *
			59.1013.309.199		384 x 309 x 314	7C2857387CP * 7C2857387CK 1, 4, 10, 12, 14, 16, 18, 23, 25, 30 *
		59.1013.401.199		384 x 330 x 257	7C2857388CC * 7C2857388BM 4, 11, 15, 17, 19, 22, 25, 31 *	
		59.1013.412.199		384 x 330 x 257	7C2857388BT * 7C2857388BP 2, 3, 4, 11, 13, 15, 17, 19, 22, 25, 31 *	
L H D		2	59.1013.501.199		384 x 434 x 191	7CB857387BE v 7CB857387BA 4, 5, 14, 16, 18, 23, 25, 32 *
			59.1013.509.199		384 x 434 x 191	7CB857387BC v 7CB857387AT 4, 5, 7, 12, 14, 16, 18, 23, 25, 32 *
		59.1013.601.199		384 x 434 x 238	7CB857388AL v 7CB857388AJ 4, 6, 15, 17, 19, 22, 25, 33 *	
		59.1013.612.199		384 x 434 x 238	7CB857388AN v 7CB857388AG 4, 6, 8, 9, 13, 15, 17, 19, 22, 25, 33 *	

* Der Komplettspiegel besteht aus den aufgelisteten Positionen.
Die Zuordnung zu den entsprechenden Artikelnummern befindet sich auf der rechten Seite.
The complete mirror consists of the items listed.
The allocation to the corresponding article number is on the right-hand side.

MAN

1013	NEW	II (E1) 041427			INTEGR.			
		Beschreibung description descripção descrizione description benámening Popis описанье leírás opis				OE		
19.1013.011.099						a	211 x 169 x 19	MAN 65.63733-0002 MAN 65.63733-0015
19.1013.012.099						b	211 x 169 x 19	MAN 65.63733-0006 MAN 65.63733-0014

2017

TGE



MAN

Pos.	MEKRA	MAN	FM	LTE	GNSS	Navigation	1200	12V	U	Phone	Navigation	Navigation	Rumpfspiegel - carcase
1	08.1013.007.000	65.28205-6000											
2	08.1013.008.000	65.28205-6001											
3	08.1013.009.000	65.28205-6002											
4	08.1013.010.000	65.63734-0002											
5	08.1013.012.100	65.25320-6001											
6	08.1013.013.100	65.25320-6002											
7	08.1013.107.000	65.28205-0005											
8	08.1013.108.000	65.28205-0006											
9	08.1013.109.000	65.28205-0007											
10	08.1013.712.100	65.25320-6003											
11	08.1013.713.100	65.25320-6004											
12	11.1013.015.000	65.28240-0000											
13	11.1013.016.000	65.28240-0001											
14	13.1013.001.000	65.63732-0002											
15	13.1013.002.000	65.63732-0003											
16	13.1013.003.000	65.63732-0000											
17	13.1013.004.000	65.63732-0001											
18	19.1013.011.004	65.63733-0015											
19	19.1013.012.004	65.63733-0014											
20	19.1013.411.004	65.63733-0013											
21	19.1013.412.004	65.63733-0012											
22	61.1013.002.004	65.63732-6001											
23	61.1013.003.004	65.63732-6000											
24	61.1013.001.004	65.63734-0000											
25	61.1013.005.004	65.63731-6008											
26	61.1013.103.004	65.63731-6031											
27	61.1013.116.004	65.63731-6033											
28	61.1013.203.004	65.63731-6032											
29	61.1013.216.004	65.63731-6034											
30	61.1013.316.004	65.63731-6037											
31	61.1013.416.004	65.63731-6038											
32	61.1013.501.004	65.63731-6025											
33	61.1013.601.004	65.63731-6026											

MAN

276

II 02★0524 II 02★ 0423
 II 010524 II 010423
 II 03★0022 II 03★0088
 II 020905 II 020923



Beschreibung
description
descripción
descrizione
descripcion
benamning
pops
omicaune
üzeylik
opis



1	59.2762.101		592 x 205 x 120	
	51.3732.326		384 x 205 x 116	81.63730-6374 + 81.63730-6390
	15.3731.470H		369 x 190 x 42	81.63733-6029 + 81.63733-0075
	11.3730.210H		367 x 187 x 60	81.63732-0058
2	59.2762.322		592 x 205 x 120	
	51.3732.326		384 x 205 x 116	81.63730-6374 + 81.63730-6390
	15.3731.470H		369 x 190 x 42	81.63733-6029 + 81.63733-0075
	11.3730.210H		367 x 187 x 60	81.63732-0058
	59.2762.422		592 x 205 x 120	
	51.3731.326		384 x 205 x 116	81.63730-6375
	15.3731.470H		369 x 190 x 42	81.63733-6029 + 81.63733-0075
	11.3730.210H		367 x 187 x 60	81.63732-0058
	20.2710.620		124 x 59 x 21 [500]	36.63731-6000

271

II 02★0524
 II 010524



Beschreibung
description
descripción
descrizione
descripcion
benamning
pops
omicaune
üzeylik
opis



1	59.2712.111		783 x 703 x 212	83.63700-6502 + 81.63700-6091
	51.3731.326		384 x 205 x 116	81.63730-6375
	15.3731.470H		369 x 190 x 42	81.63733-6029 + 81.63733-0075
	15.2711.114		165 x 93 x 25	81.63733-6027
	11.3730.210H		367 x 187 x 60	81.63732-0058
	20.2700.200H		126 x 25ø	
	20.2710.200H		183 x 181 x 84	81.63731-0289
	20.2480.216H		108 x 50 x 15 [2000]	83.63731-6507
2	59.2712.114		641 x 701 x 200	83.63700-6501 + 81.63700-6092
	51.3732.326		384 x 205 x 116	81.63730-6374 + 81.63730-6390
	15.3731.470H		369 x 190 x 42	81.63733-6029 + 81.63733-0075
	15.2711.114		165 x 93 x 25	81.63733-6027
	15.2712.114		152 x 128 x 23	81.63733-6028
	11.3730.210H		367 x 187 x 60	81.63732-0058
	20.2700.200H		126 x 25ø	
	20.2710.200H		183 x 181 x 84	81.63731-0289
		20.2480.217H		108 x 50 x 15 [5000]

2002
2002
09/2012

Euroliner
Trendliner
PLAXTON: Elite



09/99
09/01
2002
2003

Intercity Mega S 2000
R07/08, A 20
Euroliner
Trendliner
Tourliner
Lions Coach Fortuna



MAN

278		II 03★0128 II 020951 IV 03★0129 IV 020952			
MEKRA LANG Group		Beschreibung description descripção descripzione benáhmning pops описанье leirás opis	mm		OE
59.2780.120.099		684 x 247 x 174	88.63700-6059	1	
59.2781.120		684 x 247 x 174			
59.2780.200.001		684 x 247 x 174			
59.2780.140.001		684 x 247 x 174	83.63700-6510	2	
59.2780.150.001		684 x 247 x 174	83.63700-6511		
59.2780.180.001		684 x 247 x 174			
59.2780.170.001		684 x 247 x 174			
20.2710.620		124 x 59 x 21 [500]			
20.2710.650		124 x 59 x 21 [3500]			
08.3200.233H		42 x 42 x 54	81.25525-0232		
15.2780.840		307 x 177 x 22	81.63733-0113		
15.2780.841F		307 x 177 x 22			
15.2780.870		177 x 177 x 34	81.63733-0112		
15.2780.871F		177 x 177 x 34			
11.2780.910		681 x 229 x 104	81.63732-0088		
11.2780.920		681 x 229 x 104	36.63732-0006		
08.5752.012		130 x 120 x 53			
08.5752.024.099		130 x 120 x 53			

MAN Lion's City
 MAN Lion's Regio
 MAN Lion's Star
 Inter Deck, IRISBUS (Citellis),
 KRAVTEX, LAZ, SOLARIS (Urbino),
 VDL (Citea), VOLVO 7900H,
 Heuliez, Caetano, Plaxton, Scania
 2007 →



1



2

MAN

MAN

277		II e1 03★0084 II (E1) 020915	Truck II	ABS	INTEGR.
MEKRA LANG Group		Beschreibung description description description benamning pops omrcauwe buelilik tehras opis		mm	OE
59.2770.210.099		1001 x 720 x 254	88.63700-6062		
59.2770.211.099		1001 x 720 x 254	88.63700-6066		
59.2771.210.099		1001 x 720 x 254	88.63700-6060		
59.2770.310.099		1001 x 720 x 254	2227 4292 (Volvo) 272 3896 (Scania)		
09.2770.210		(→ 59.2770.210.099)	6050 x 6 ø	88.25426-6837	
09.2770.211 + 09.2770.210		(→ 59.2770.211.099)	6050 x 6 ø	33.25404-6190 + 88.25426-6837	
09.2770.001.000		(→ 59.2771.210.099)	6050 x 6 ø		
08.2910.001.002	LED			33.25203-6001	
09.2910.003.099		(for LED)	6050 x 6 ø		
08.3200.233H			42 x 42 x 54	81.25525-0232	
08.2770.001.000			45 x 40 x 44	81.25505-6247	
08.3950.001.099	Control Unit (→ 59.2771.210.099)		40 x 30 x 30		
15.2771.840			307 x 183 x 23	81.63733-0110	
15.2771.870			206 x 166 x 37	81.63733-0111	
61.2770.210			670 x 280 x 253	81.63730-0083	
61.2772.211.099			670 x 280 x 253		
61.2770.211		(→ 59.2770.210.099 + 59.2770.211.099)	817 x 192 x 130	81.63731-0373	
11.2770.920			669 x 254 x 237	81.63732-0087	
11.2770.102		1	707 x 123 x 185	36.63732-0000	
11.2770.202		2	399 x 149 x 129	36.63732-0002	
11.2770.302		3	268 x 151 x 118	36.63732-0001	
11.2770.402		4	399 x 153 x 128	36.63732-0003	
61.2772.100		(for LED)	399 x 172 x 129	81.63732-0089	
08.5752.024.099			130 x 120 x 53	81.63734-6001	
61.2770.900.099	KIT 1			36.63732-6000	
61.2770.901.099	KIT 2				

MAN Lion's City
MAN Lion's Regio
MAN Lion's Star
IRISBUS (Citelis), KRAVTEX, LAZ,
VDL (Citea), VOLVO 7900H,
Heuliez, Caetano, Plaxton, Scania
2007

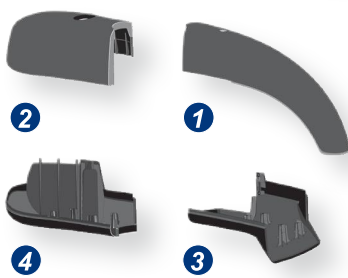

KIT 1



Scharnierdeckel
Hinge cover



Scharnierklemme
Hinge clamp



Schenkeifeder
Spring screw

KIT 2



Spann Schlüssel
Wrench



Spannhebel
Bolt lever



Druckfeder
Compression spring

MAN

1041		II (E1) 041480		Truck II	ASA	INTEGR.
MEKRA LANG Group		Beschreibung description descripção descripção benämning popis onivcaune bællik veikrás opis		mm		OE
59.1041.001.099		636 x 907 x 250	36.63700-6018			
59.1041.002.099		636 x 907 x 250	33.63700-6004			
59.1041.003.099		636 x 907 x 250	83.63700-6530			
59.1041.004.001		636 x 907 x 250		5		
15.2780.840		178 x 307 x 22	36.63733-0011	a		
19.2910.002.099		172 x 184 x 39	36.63733-0012	b		
12.1041.001.099		274 x 643 x 165	36.63732-0037			
12.1041.002.099		114 x 313 x 63	36.63732-0035	1	back	
12.1041.003.099		112 x 194 x 91	36.63732-0034	2	front	
12.1041.004.099		113 x 349 x 75	36.63732-0033	3	front	
12.1041.005.099		90 x 470 x 118	36.63732-0036	4	back	
08.1024.124.099		120 x 130 x 45 mm	81.63734-6006 3139595 (Scania)	a		
09.1041.002.099		2400	36.25404-6033	a		
09.1041.004.099		2400	33.28104-6355	b		

2019 →
Stadtbusse MAN
(Lion's City)



5 Unter 2 m verbaubar und abklappbar
Can be installed and folded away below 2 meters



2019 →

Stadtbusse MAN
(Lion's City)

1042		II (E1) 041481 IV (E1) 041482		Truck II+IV	ASA	INTEGR.
MEKRA LANG Group		Beschreibung description descripção descripção benämning popis onivcaune bællik veikrás opis		mm		OE
59.1042.001.099		685 x 176 x 237	36.63700-6017			1
59.1042.002.099		685 x 176 x 237	36.63700-6022			
59.1042.004.099		685 x 176 x 237	36.63700-6020			
59.1042.005.099		685 x 176 x 237	33.63700-6003			
59.1042.003.099		685 x 176 x 237	36.63700-6019			2
15.2780.840		178 x 307 x 22	36.63733-0011	a		
19.2910.001.099		154 x 183 x 31	36.63733-0010	b		
12.1042.001.099		232 x 528 x 87	36.63732-0040			
12.1042.002.099		232 x 528 x 87	36.63732-0041			
61.1042.005.099		127 x 172 x 111			for door	
61.1042.006.099		167 x 160 x 163			for A-Pillar	
08.1024.124.099		120 x 130 x 45 mm	81.63734-6006 3139595 (Scania)	a		
20.1042.002.099		2100	36.63731-6012			
20.1042.003.099		2500	36.63731-6013			
09.1041.004.099		2400	33.28104-6355	b		



MERCEDES

253	II 02★14067 II 0114067			Ø 18 mm
------------	-----------------------------	--	--	---------

	Beschreibung description description description benamning popis omircaune üzeylik leirats opis		OE
--	--	--	----

51.2530.120H		370 x 182 x 64	381 810 25 16* 000 810 27 16 281 810 71 16* 000 810 62 16 000 811 12 33* 314 810 26 16 381 810 71 16* 663 810 08 16 673 810 08 16* 673 810 40 16 000 811 33 33* 001 811 87 33 000 811 20 33* 000 811 64 33 000 811 21 33
40.2530.222H		356 x 170 x 3	000 811 33 33* 001 811 87 33 000 811 20 33* 000 811 64 33 000 811 21 33
61.2530.110H		55 x 43 x 36	000 811 02 39
51.2530.140H		370 x 182 x 64	381 810 73 16* 381 810 26 16 000 810 23 16* 301 810 21 16 314 810 26 16* 673 810 42 16
40.2530.422H		356 x 170 x 3	
09.2070.101H		2070 x 9ø	000 150 55 33
61.2530.110H		55 x 43 x 36	000 811 02 39

1013 - 2644
EvoBus D 303, 404, 405, 407
08/73 - 12/86



MERCEDES

254	II 01★14068			Ø 18 mm
------------	--------------	--	--	---------

	Beschreibung description description description benamning popis omircaune üzeylik leirats opis		OE
--	--	--	----

51.2540.120H		305 x 183 x 60	314 810 13 16* 000 810 04 16 000 810 48 16* 673 810 39 16 000 811 35 33* 001 811 90 33 000 811 19 33
40.2540.222H		291 x 170 x 3	000 811 35 33* 001 811 90 33 000 811 19 33
61.2530.110H		55 x 43 x 36	000 811 02 39
51.2540.130H		305 x 183 x 60	314 810 19 16* 000 810 06 16 000 810 20 16
40.2540.222H		291 x 170 x 3	000 811 35 33* 001 811 90 33 000 811 19 33
09.2070.101H		2070 x 9ø	000 150 55 33
61.2530.110H		55 x 43 x 36	000 811 02 39
51.2540.140H		305 x 183 x 60	314 810 20 16* 673 810 41 16
40.2540.422H		291 x 170 x 3	001 811 90 33 + 000 821 08 29
09.2070.101H		2070 x 9ø	000 150 55 33
61.2530.110H		55 x 43 x 36	000 811 02 39

11/77
12/98

LK08 - 1113
LN2 (LK)



MERCEDES

375	II 03★0123 II 020941 II 02★0505 II 010505		Ø 28 mm
------------	--	--	---------

		Beschreibung description descripción descrizione benámining þopps ömricauwe breiðlik leirrás optis		OE
61.3752.147H			380 x 170 x 68	000 810 02 79
15.3752.470H			380 x 170 x 15	001 811 34 33+ 001 811 73 33
61.3780.100H			74 x 65 x 14	000 811 13 07
61.3752.167H			380 x 170 x 68	000 810 03 79
15.3752.470H			380 x 170 x 15	001 811 34 33+ 001 811 73 33
61.3780.100H			74 x 65 x 14	000 811 13 07

Atego (LKN)
Axor
Unimog U 20



MERCEDES

377 377-1	IV 02★0462 IV 010462 IV 03★0019		Ø 28 mm
----------------------------	--	--	---------

		Beschreibung description descripción descrizione benámining þopps ömricauwe breiðlik leirrás optis		OE
61.3770.147H			200 x 200 x 155	000 810 96 16 + 001 811 21 33 + 000 811 13 07
15.3774.410H			200 x 200 x 15	001 811 21 33
61.3772.147H			200 x 200 x 118	000 810 96 16
61.3780.100H			74 x 65 x 14	000 811 13 07
61.3773.147H			200 x 200 x 155	001 810 92 16 + 000 811 13 07
15.3771.174H			200 x 200 x 15	001 811 60 33
61.3780.100H			74 x 65 x 14	000 811 13 07



Atego (LKN)
Axor

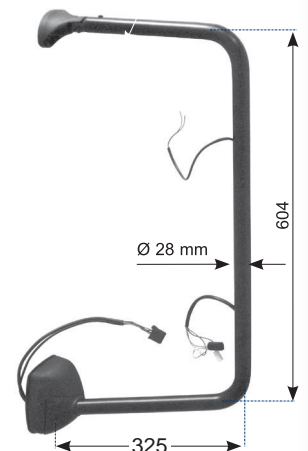

375 A			Ø 28 mm
--------------	--	--	---------

		Beschreibung description descripción descrizione benámining þopps ömricauwe breiðlik leirrás optis		OE
58.3752.100			639 x 325 x 28 ø	973 810 03 14
58.3752.200			639 x 325 x 28 ø	973 810 04 14
20.3750.710.099			136 x 82 x 73	000 811 03 61
20.3750.720.099			136 x 82 x 73	000 811 04 61

MERCEDES

Atego II (LKN)
Axor II



10/04
10/04

575		II (E1) 021144				Ø 28 mm
MEKRA LANG Group		Beschreibung description descripção descripzione benamining popis оригинале üzeylik leirás opis		mm		OE
51.5750.003.099		24V		439 x 219 x 124	000 810 17 79 + 000 810 22 79	
51.5750.004.099		24V		439 x 219 x 124	000 810 14 79 + 000 810 23 79	
09.5750.220.099				250	000 820 28 13	
51.5750.001.099		24V		439 x 219 x 124	000 810 18 79 + 000 810 20 79	
51.5750.002.099		24V		439 x 219 x 124	000 810 15 79 + 000 810 21 79	
09.5750.001.099				335	000 820 27 13	
19.5750.011.099		24V	07/10	435 x 196 x 39	002 811 46 33	
15.5750.840H		24V	06/10	431 x 186 x 15	001 811 99 33	
61.5750.100H				86 x 79 x 77	000 811 20 07	



577		IV (E1) 021145				Ø 28 mm
MEKRA LANG Group		Beschreibung description descripção descripzione benamining popis оригинале üzeylik leirás opis		mm		OE
51.5770.001.099		24V		214 x 199 x 116	000 810 16 79 + 000 810 24 79	
19.5770.311.099		300	07/10	203 x 200 x 43	002 811 47 33	
15.5770.870H		300	06/10	192 x 186 x 15	002 811 00 33	
09.5750.220.099				250	000 820 28 13	
61.5750.100H				86 x 79 x 77	000 811 20 07	

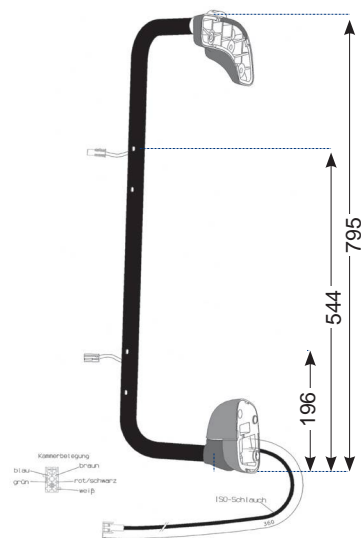

575 A					Ø 28 mm	
MEKRA LANG Group		Beschreibung description descripção descripzione benamining popis оригинале üzeylik leirás opis		mm		OE
58.5752.100H			03/13	795 x 321 x 28 ø	001 810 97 14	
58.5752.200H			03/13	795 x 376 x 28 ø	001 810 98 14	
58.5752.300H			03/13	795 x 376 x 28 ø	001 810 99 14	
58.5752.400E			03/13	795 x 321 x 28 ø	002 810 00 14	
58.5750.012.199			04/13	795 x 322 x 28 ø	002 810 85 14	
58.5750.005.199			04/13	795 x 322 x 28 ø	002 810 94 14	
20.5750.710.099				134 x 80 x 74	000 811 18 07	
20.5750.720.099				134 x 80 x 74	000 811 19 07	

MERCEDES

579	V 03★0109			
	V 021179			
	Beschreibung description descripção descripziune benamning popis описание özellik leirás opis			OE
56.5790.004.099		303 x 163 x 88	002 810 08 16	
15.5791.470H		303 x 163 x 55	002 811 22 33	

*Atego (LKN)
Axor
Atego II (LKN)
Axor II*

*01/98 - 05/08
09/01 - 09/04
10/04 →
10/04 →*



New Regulation ECE R46/04



MERCEDES

1004	V 04 1341			
	Beschreibung description descripção descripziune benamning popis описание özellik leirás opis			OE
56.1004.001.099		338 x 275 x 105	002 810 60 16	

396	VI 03★0017			INTEGR.
	Beschreibung description descripção descripziune benamning popis описание özellik leirás opis			OE
59.3962.210H	1	1261 x 303	973 810 73 16	
59.3964.210H	2	1145 x 265	940 810 55 16	
56.3960.148H		130 x 250 ø	000 810 08 79 + 001 811 69 33 + 000 811 13 07	
15.3961.174H		45 x 250 ø	001 811 69 33	
61.3780.100H		74 x 65 x 14	000 811 13 07	

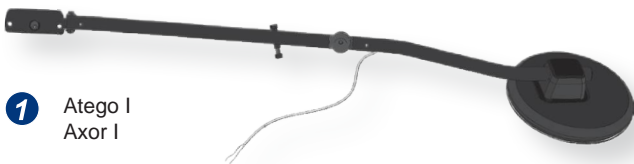

MERCEDES

378 378-1	II [E1] 02★0463 II [E1] 010463 II [E1] 03★0018			Ø 28 mm
----------------------------	--	--	--	---------

	Beschreibung description descripção descrizione benamning poppis õniveaune õzellik õpõis		mm	OE
--	--	--	----	----

61.3780.147H		433 x 188 x 85	
15.3784.470H		433 x 188 x 15	001 811 20 33
61.3782.147H		433 x 188 x 68	000 810 95 16
61.3780.100H		74 x 65 x 14	000 811 13 07
61.3783.147H		433 x 188 x 68	
15.3780.840H		433 x 188 x 15	002 811 04 33
61.3780.100H		74 x 65 x 14	000 811 13 07
61.3782.167H		433 x 188 x 68	000 810 94 16
15.3784.470H		433 x 188 x 15	001 811 20 33
61.3780.100H		74 x 65 x 14	000 811 13 07
61.3783.167H		433 x 188 x 68	
15.3780.840H		433 x 188 x 15	002 811 04 33
61.3780.100H		74 x 65 x 14	000 811 13 07

Actros (SKL) I+II
Econic

09/96
03/98



MERCEDES

377 377-1	IV [E1] 02★0462 IV [E1] 010462 IV [E1] 03★0019			Ø 28 mm
----------------------------	--	--	--	---------

	Beschreibung description descripção descrizione benamning poppis õniveaune õzellik õpõis		mm	OE
--	--	--	----	----

61.3770.147H		200 x 200 x 155	
15.3774.410H		200 x 200 x 15	001 811 21 33
61.3772.147H		200 x 200 x 118	000 810 96 16
61.3780.100H		74 x 65 x 14	000 811 13 07
61.3773.147H		200 x 200 x 155	
15.3771.174H		200 x 200 x 15	001 811 60 33
61.3780.100H		74 x 65 x 14	000 811 13 07

Actros (SKL) I+II
Econic

09/96 - 05/08
03/98

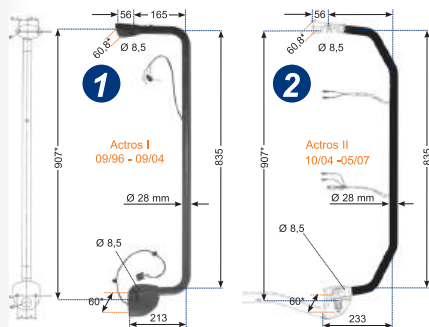











378 A			Ø 28 mm
--------------	--	--	---------

	Beschreibung description descripção descrizione benamning poppis õniveaune õzellik õpõis		mm	OE
--	--	--	----	----









58.3781.100H		983 x 197 x 28	001 810 44 14
58.3781.200H		983 x 197 x 28	001 810 45 14
58.3783.300H		983 x 227 x 28	002 810 08 14
58.3783.200H		983 x 227 x 28	002 810 09 14
20.3780.700H		96 x 91 x 88	941 811 00 07

MERCEDES

579	V e1 03★0109			
	V E1 021179			
	Beschreibung description descripção descripziune benamining popis opis opis		OE	
56.5790.004.099	   	303 x 163 x 88	002 810 08 16	
15.5791.470H	 	303 x 163 x 55	002 811 22 33	

Actros (SKL) I+II
Econic
09/96 - 05/08
03/98 →



















1004	V E1 04 1341			
	Beschreibung description descripção descripziune benamining popis opis opis		OE	
56.1004.001.099	   	338 x 275 x 105	002 810 60 16	

New Regulation ECE R46/04



MERCEDES

396	VI e1 03★0017			INTEGR.
	Beschreibung description descripção descripziune benamining popis opis opis		OE	
59.3965.210H	    	1219 x 303	943 810 47 16	
56.3960.148H	 	130 x 250 ø	000 810 08 79 + 001 811 69 33 + 000 811 13 07	
15.3961.174H	  	45 x 250 ø	001 811 69 33	
61.3780.100H	 	74 x 65 x 14	000 811 13 07	

Actros I + II



MERCEDES

ACTROS MP3



1012	ECE	II + IV Truck	
MEKRA LANG Group	Beschreibung description descripção descripziune benämning popis opisčanica özelliik leirás opis		OE
19.1012.002.099			a
19.1012.003.099			a
19.1012.000.099			b
19.1012.001.099			b

10/2011
07/2012
05/2013

ACTROS MP4
ANTOS
AROCS
(SFTP)



600	II (E1) 02★1112 IV (E1) 02★1113	II + IV Truck	ABS	INTEGR.
MEKRA LANG Group	Beschreibung description descripção descripziune benämning popis opisčanica özelliik leirás opis		OE	
15.6000.001.099			a	
15.6000.002.099			a	
15.6000.003.099			b	
15.6000.004.099			b	

Komplettsystem (MP3 + MP4) bei Mercedes erhältlich
complete system (MP3 + MP4) available at Mercedes

ACTROS MP3
ACTROS MP4
ANTOS
AROCS
(SFTP)



1004	V (E1) 04 1341	V Truck	ABS	
MEKRA LANG Group	Beschreibung description descripção descripziune benämning popis opisčanica özelliik leirás opis		OE	
56.1004.001.099				

New Regulation ECE R46/04



Electronics and Accessories

Product Catalog for Camera Monitor Systems and Active Alarm Systems

Download



MERCEDES

1994 →
EvoBus Kombibus
Ares (Renault, Karosa, Iveco)



281	II E1 02★0447 II E1 010447 II E1 02★0448	Truck II	ABS	INTEGR.
	Beschreibung description descripção descripzione descripció benámenning popis omicawire özzeilikk leirás opis	mm	OE	
59.2810.111H		470 x 230 x 85		
59.2810.113H		470 x 230 x 85		
15.2810.480H		409 x 168 x 6		
11.2810.200H		460 x 180 x 50		

1999 →

Conecto CÜ
Intouro



398	II E1 03★0123 II E1 020941 II E1 02★0505 II E1 010505	Truck II	ABS	
	Beschreibung description descripção descripzione descripció benámenning popis omicawire özzeilikk leirás opis	mm	OE	
1	59.3980.021H		551 x 278 x 147	671 810 09 16
	59.3980.022H		551 x 1278 x 47	671 810 13 16
2	59.3980.121		435 x 246 x 143	628 810 30 16
	59.3980.122		435 x 246 x 143	628 810 31 16
3	59.3980.011H		474 x 733 x 166	671 810 07 16
	59.3980.012		474 x 733 x 166	671 810 12 16
	59.3980.111		474 x 733 x 166	628 810 33 16
	59.3980.112		474 x 733 x 166	628 810 34 16
4	59.3980.132		622 x 758 x 224	628 810 37 16
	59.3980.141		622 x 758 x 224	633 810 01 16
	59.3980.142		622 x 758 x 224	633 810 02 16
	61.3752.147H		380 x 170 x 68	000 810 02 79
	61.3752.167H		380 x 170 x 68	000 810 03 79
	15.3752.470H		380 x 170 x 15	001 811 34 33 + 001 811 73 33
	61.3773.147H		200 x 200 x 155	001 810 92 16
	15.3771.174H		200 x 200 x 15	001 811 60 33
	61.3780.100H		74 x 65 x 14	000 811 13 07
	20.2480.216H		108 x 50 x 15 [2000]	
	20.2480.217H		108 x 50 x 15 [5000]	



09/97 →
10/03 →
09/99 →
09/97 →
Travego
Tourino
Setra TC 400
Multego
Tourismo



395	II E1 02★0620 II E1 020926 II E1 010620 V E1 03★0174 II E1 03★0047 V E1 020998	II + V		
	Beschreibung description descripção descripzione descripció benámenning popis omicawire özzeilikk leirás opis	mm	OE	
	15.3951.174		368 x 174 x 15	629 811 00 33
	15.3951.114		202 x 153 x 15	629 811 01 33

MERCEDES

249 K	III e1 01★17023		PP	① Ø 10 mm ② Ø 12 mm
Beschreibung description descripção descripziune descripziôn benamining popis opis ovis ovis ovis ovis ovis ovis				OE
51.2491.121H		①	210 x 140 x 21	460 810 01 16 + 601 810 02 16 460 810 03 16
51.2491.122H		②	210 x 140 x 21	601 810 01 16

249 L	II e1 02★14035 II E1 0114035		PP	① Ø 10 mm ② Ø 14 - 20 mm
Beschreibung description descripção descripziune descripziôn benamining popis opis ovis ovis ovis ovis ovis ovis				OE
51.2493.121H		①	247 x 157 x 61	612 810 01 66 + 611 810 01 16
51.2493.127H		②	247 x 157 x 61	

349 349 TW	II e1 02★0384 II E1 010384 II e1 02★0418 II E1 010418		ABS	① INTEGR. ③ Ø 18 mm
Beschreibung description descripção descripziune descripziôn benamining popis opis ovis ovis ovis ovis ovis ovis				OE
51.3490.110H		①	283 x 295 x 80	901 810 01 16 + 901 810 55 16
15.3491.071H			238 x 142 x 6	001 811 06 33
51.3490.120H		①	283 x 340 x 80	901 810 02 16 + 901 810 64 16
15.3491.072H			238 x 142 x 6	001 811 07 33
51.3490.112H		①	283 x 295 x 80	901 810 09 16 + 901 810 57 16
15.3491.371H			238 x 142 x 6	001 811 05 33
51.3490.122H		①	283 x 340 x 80	901 810 10 16 + 901 810 66 16
15.3491.372H			238 x 142 x 6	001 811 04 33
56.3491.110H		②	175 x 116 x 70	901 810 10 93 + B 66 5603 97
15.2711.214H			165 x 93 x 15	
56.3492.110H		②	175 x 116 x 70	901 810 11 93 + B 66 5603 98
15.2711.214H			165 x 93 x 15	
59.3491.110H		③	283 x 495 x 80	901 810 25 16 + 901 810 58 16
59.3492.110H			283 x 465 x 80	901 810 37 16 + 901 810 61 16
15.3491.071H			238 x 142 x 6	001 811 06 33
59.3491.120H		③	283 x 535 x 80	901 810 26 16 + 901 810 67 16
59.3492.120H			283 x 535 x 80	901 810 38 16 + 901 810 70 16
15.3491.072H			238 x 142 x 6	001 811 07 33

05/77 - 07/81
05/79 →
Transporter
207D - 308 (T1, TN)
Typ 230 GE, 280 GE
Typ 240 GD, 300 GD



08/81 - 02/95
Transporter
207D - 410 (T1, TN)



01/95 - 09/05
Sprinter (T1N)

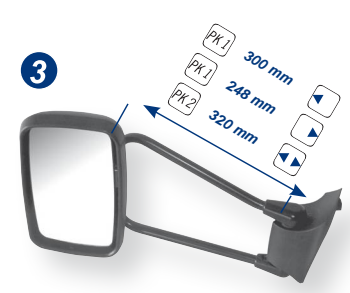

MERCEDES

MERCEDES

Mercedes Sprinter II
(NCV3)
10/2005 - 11/2017

589	II III e1 03★0006		INTEGR.
	II III E1 020902		

MEKRA LANG Group

Beschreibung description descripción descripción descripción benámenning þýttalík íritrás opis

mm

OE

MERCEDES



* mit beheizter Weitwinkel - Glaseinheit, nur verwendbar für Fahrzeuge ab "EURO 5" with heated wide angle mirror glass unit, suitable from "EURO 5" vehicles only



L H D	1	51.5891.111.199			344 x 315 x 182	906 810 48 16 + 906 810 18 93		
		51.5891.112.199 *		12 V	344 x 315 x 182	906 810 30 93		
		51.5891.113.199		12 V	344 x 315 x 182	906 810 60 16		
		51.5891.114.199 *		12 V	PARK PILOT	344 x 315 x 182	906 810 42 93	
		51.5894.112.199 *		12 V	ohne w/o sans	344 x 315 x 182	906 810 65 93	
	R H D		51.5891.311.199			344 x 345 x 182	906 810 51 16 + 906 810 21 93	
			51.5894.310.199		ohne w/o sans	344 x 345 x 182	906 810 64 93	
			51.5891.312.199 *		12 V		344 x 345 x 182	906 810 33 93
			51.5891.313.199		12 V		344 x 345 x 182	906 810 63 16
		51.5891.314.199 *		12 V	PARK PILOT	344 x 345 x 182	906 810 45 93	
L H D		51.5891.211.199			344 x 345 x 182	906 810 49 16 + 906 810 19 93		
		51.5891.212.199 *		12 V		344 x 345 x 182	906 810 31 93	
		51.5891.213.199		12 V		344 x 345 x 182	906 810 61 16	
		51.5891.214.199 *		12 V	PARK PILOT	344 x 345 x 182	906 810 43 93	
		51.5894.212.199 *		12 V	ohne w/o sans	344 x 345 x 182	906 810 66 93	
	R H D		51.5891.411.199			344 x 315 x 182	906 810 50 16 + 906 810 20 93	
		51.5894.410.199		ohne w/o sans	344 x 315 x 182	906 810 63 93		
		51.5891.412.199 *		12 V		344 x 315 x 182	906 810 32 93	
		51.5891.413.199		12 V		344 x 315 x 182	906 810 62 16	
		51.5891.414.199 *		12 V	PARK PILOT	344 x 315 x 182	906 810 44 93	
L H D	2	51.5892.111.199			344 x 509 x 182	906 810 52 16 + 906 810 22 93		
		51.5892.112.199 *		12 V		344 x 509 x 182	906 810 34 93	
		51.5892.113.199		12 V		344 x 509 x 182	906 810 64 16	
	R H D		51.5892.311.199			344 x 460 x 182	906 810 55 16 + 906 810 25 93	
			51.5892.312.199 *		12 V		344 x 460 x 182	906 810 37 93
			51.5892.313.199		12 V		344 x 460 x 182	906 810 67 16
	51.5895.312.199 *		12 V	ohne w/o sans	344 x 460 x 182	906 810 80 93		
L H D		51.5892.211.199			344 x 460 x 182	906 810 53 16 + 906 810 23 93		
		51.5892.212.199 *		12 V		344 x 460 x 182	906 810 35 93	
		51.5892.213.199		12 V		344 x 460 x 182	906 810 65 16	
	R H D		51.5892.411.199			344 x 509 x 182	906 810 54 16 + 906 810 24 93	
		51.5892.413.199		12 V		344 x 509 x 182	906 810 66 16	
		51.5895.412.199 *		12 V	ohne w/o sans	344 x 509 x 182	906 810 79 93	
L H D	3	51.5893.111.199			344 x 543 x 182	906 810 56 16 + 906 810 26 93		
		51.5893.112.199 *		12 V		344 x 543 x 182	906 810 38 93	
		51.5893.113.199		12 V		344 x 543 x 182	906 810 68 16	
		51.5893.211.199			344 x 511 x 182	906 810 57 16 + 906 810 27 93		
		51.5893.212.199 *		12 V		344 x 511 x 182	906 810 39 93	
		51.5893.213.199		12 V		344 x 511 x 182	906 810 69 16	

MERCEDES

589

II III e1 03★0006

II III E1 020902



Beschreibung
description
description
description
description
benamning
Popis
omircaune
brevlik
letrals
opis



OE

15.5891.741H		236 x 155 x 16	002 811 15 33	a
15.5891.742H		236 x 155 x 16	002 811 16 33	
15.5891.611H		154 x 59 x 19	002 811 19 33	b
15.5891.612H		154 x 59 x 19	002 811 20 33	
19.5890.011.099		240 x 158 x 21	002 811 52 33	c
19.5890.012.099		240 x 158 x 21	002 811 53 33	
19.5891.011.099		240 x 158 x 21	002 811 56 33	
19.5891.012.099		240 x 158 x 21	002 811 57 33	
08.5890.300.099		113 x 32 x 15	000 440 00 15	
08.5890.301.099		113 x 32 x 15	000 440 01 15	
15.5891.721.099		157 x 65 x 20	002 811 39 33	d
15.5891.722.099		157 x 65 x 20	002 811 40 33	
13.5890.110.199		344 x 218 x 82	000 811 10 22	
13.5890.210.199		344 x 218 x 82	000 811 11 22	
13.5890.120.099		344 x 201 x 82	001 811 00 22	
13.5890.220.099		344 x 201 x 82	001 811 01 22	
14.5890.100.099		337 x 192 x 56	000 813 04 36	
14.5890.200.099		337 x 192 x 56	000 813 05 36	
08.5892.001.099		13 133 x 118 x 88	001 822 89 20 + 000 820 12 77	
08.5892.002.099		13 133 x 118 x 88	001 822 93 20 + 000 820 12 77	
08.5892.003.099		13 133 x 118 x 88	001 822 90 20 + 000 820 12 77	
08.5892.004.099		13 133 x 118 x 88	001 822 92 20 + 000 820 12 77	
08.5892.105.099		12 51 x 27 ø	000 820 12 77	

Mercedes Sprinter II (NCV3) 10/05 - 09/10



MERCEDES

Sprinter II Euro 5 + 6 10/2010 - 11/2017

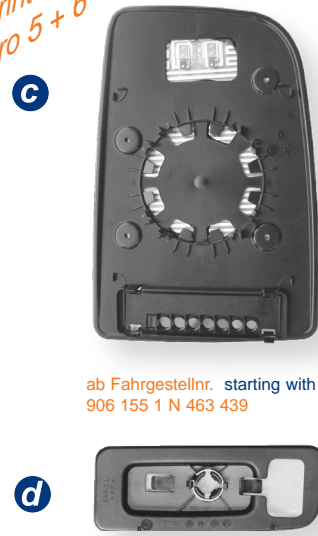

ab Fahrgestellnr. starting with chassis no. 906 155 1 N 463 439



ab Fahrgestellnr. starting with chassis no. 906 155 1 N 416 545



2018

MERCEDES

1039

NEW

II (E1) 041469



ABS

INTEGR.



Beschreibung
description
description
descripção
description
benamning
pops
omrcauwe
bœrellik
reirais
oyps



OE

Sprinter III
W907 und W910



1

L
H
D

R
H
D

59.1039.125.099		423 x 280 x 160	9108100300
59.1039.225.099		423 x 280 x 160	9108100400
59.1039.101.099		423 x 280 x 160	9108108901
59.1039.201.099		423 x 280 x 160	9108109001
59.1039.104.099		423 x 280 x 160	9108101100
59.1039.204.099		423 x 280 x 160	9108101200
59.1039.105.099		423 x 280 x 160	9108101900
59.1039.205.099		423 x 280 x 160	9108102000
59.1039.175.099		423 x 280 x 160	9108100500
59.1039.275.099		423 x 280 x 160	9108100600
59.1039.151.099		423 x 280 x 160	9108109101
59.1039.251.099		423 x 280 x 160	9108109201
59.1039.158.099		423 x 280 x 160	9108109501
59.1039.258.099		423 x 280 x 160	9108109601
59.1039.154.099		423 x 280 x 160	9108101300
59.1039.254.099		423 x 280 x 160	9108101400
59.1039.155.099		423 x 280 x 160	9108102100
59.1039.255.099		423 x 280 x 160	9108102200
19.1039.411.099		1 207 x 139 x 20	9108112500
19.1039.412.099		1 207 x 139 x 20	9108112400
19.1039.011.099		1 207 x 139 x 20	9108112700
19.1039.012.099		1 207 x 139 x 20	9108112600
19.1039.811.099		207 x 139 x 20	9108112900
19.1039.812.099		207 x 139 x 20	9108112800
19.1039.311.099		2 137 x 70 x 20	9108113700
19.1039.312.099		2 137 x 70 x 20	9108113600
13.1039.001.099		3 308 x 216 x 104	9108114100
13.1039.002.099		3 308 x 216 x 104	9108114000
11.1039.011.099		4 308 x 189 x 60	9108113900
11.1039.012.099		4 308 x 189 x 60	9108113800
08.1039.011.099		5 Ø 38 x 15	9109065600
61.1039.002.099		6 Ø 36 x 19	9108250400
08.1039.001.099		7 87 x 67 x 54	9109064700
08.1039.002.099		7 87 x 67 x 54	9109064600
11.1039.001.099		62 x 87 x 27	9108114500
11.1039.002.099		62 x 87 x 27	9108114400
08.1039.005.099		35 x 42 x 12	9105420100
08.1039.006.099		35 x 42 x 12	9105420000



MERCEDES

1039 **NEW** II III (E1) 02★0902 ABS INTEGR.

MEKRA LANG Group Beschreibung description descripción descripción description benámining popis omírcauwe брэйтлік лэйтэіс optis OE

59.1039.525.099		423 x 447 x 270	9108100401	2 LHD RHD	
59.1039.625.099		423 x 447 x 270	9108100501		
59.1039.501.099		423 x 447 x 270	9108100801		
59.1039.601.099		423 x 447 x 270	9108100901		
59.1039.575.099		423 x 447 x 270	9108100601		
59.1039.675.099		423 x 447 x 270	9108100701		
59.1039.551.099		423 x 447 x 270	9108101001		
59.1039.651.099		423 x 447 x 270	9108101101		
59.1039.558.099		423 x 447 x 270	9108107001		
59.1039.658.099		423 x 447 x 270	9108107101		

59.1039.701.099		423 x 502 x 343	9108101601	3 LHD RHD	
59.1039.801.099		423 x 502 x 343	9108101701		
59.1039.751.099		423 x 502 x 343	9108101801		
59.1039.851.099		423 x 502 x 343	9108101901		

19.5890.011.099		8 240 x 158 x 21	0028115233	2 + 3	
19.5890.012.099		8 240 x 158 x 21	0028115333		
15.5891.721.099		9 157 x 65 x 20	0028113933		
15.5891.722.099		9 157 x 65 x 20	0028114033		
13.5890.110.199		10 344 x 218 x 82	0008111022		
13.5890.120.099		344 x 218 x 82	0018110022		
13.5890.210.199		10 344 x 218 x 82	0008111122		
13.5890.220.099		344 x 218 x 82	0018110122		
14.5890.100.099		11 337 x 192 x 56	0008130436		
14.5890.200.099		11 337 x 192 x 56	0008130536		
08.5892.105.099		12 Ø 51 x 27	0008201277		
08.5892.002.099		13 133 x 118 x 88	0018229320 + 0008201277		
08.5892.003.099		13 133 x 118 x 88	0018229420 + 0008201277		

Sprinter III
W907 und W910

MERCEDES



RENAULT

390	II 03★0009 II 020914 IV 03★0037 IV 020916			INTEGR.
------------	--	--	--	----------------

	Beschreibung description descripción descrizione benámenning popis omlcauwe öreňlik opis		OE
--	--	--	-----------

59.3900.143H		880 x 340 x 155	50.10.623.231
59.3900.243H		880 x 340 x 155	50.10.623.232 + 74.21.326.527
59.3900.133H		880 x 440 x 155	50.10.623.246
59.3900.233H		880 x 440 x 155	50.10.623.247 + 74.21.326.526
59.3900.343		880 x 340 x 155	
59.3900.443		880 x 340 x 155	
59.3900.333		880 x 440 x 155	
59.3900.433		880 x 440 x 155	
15.3900.840H		337 x 202 x 25	74.20.862.795
15.3911.871H		200 x 197 x 75	74.20.862.810
15.3911.872H		200 x 197 x 75	74.20.862.815
61.3900.100H		373 x 245 x 101	74.20.862.782
61.3900.110H		373 x 245 x 101	74.20.866.665
61.3900.120H		373 x 245 x 101	74.20.913.815 + 74.85.120.820
61.3900.130H		373 x 245 x 101	74.85.120.820
61.3911.110H		245 x 236 x 105	74.20.862.809
61.3911.120H		245 x 236 x 105	74.20.862.813
11.3900.200H		371 x 244 x 80	74.20.862.779
11.3910.200H		244 x 225 x 75	74.20.862.800
08.5752.024.099		130 x 120 x 53	74.20.866.672 + 74.20.862.812 74.21.618.499
09.3900.003.000		300 x 6 ø	74.21.614.025
20.3900.510H		518 x 160 x 98	50.10.623.057
20.3900.520H		518 x 160 x 98	50.10.623.058

1033	II 03★0009 II 020914 IV 03★0037 IV 020916			INTEGR.
-------------	--	--	--	----------------

	Beschreibung description descripción descrizione benámenning popis omlcauwe öreňlik opis		OE
--	--	--	-----------

19.1033.001.199		365 x 200	7482408450
19.1033.002.199		201 x 191	7482408451

Midlum 1818
 Premium Distribution
 Kerax
 D-Serie
 C-Serie (2,3 m)

05/06 - 09/13
 05/06 - 09/13
 05/06 - 09/13
 10/13
 10/13

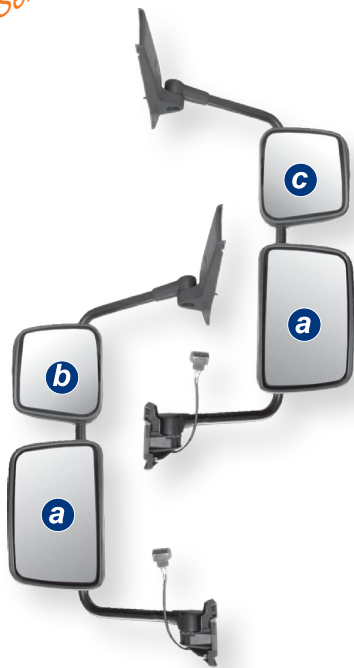

T-Series

06/13

RENAULT

390	II [e1] 03★0009		ABS	INTEGR.
	II [e1] 020914			
	IV [e1] 03★0010			
	IV [e1] 020913			

MEKRA LANG Group	Beschreibung / description / descrição / descrizione / benámining / popis / опис / özeilik / leirás / opis					mm	OE
	Icons	Icons	Icons	Icons	Icons		
59.3900.123H						880 x 340 x 155	50.10.578.503
59.3900.223H						880 x 340 x 155	50.10.578.504 + 74.21.326.550
59.3900.323						880 x 340 x 155	
59.3900.423H						880 x 340 x 155	
15.3900.840H						337 x 202 x 25	74.20.862.795
15.3910.871H						203 x 189 x 75	74.20.903.745
15.3910.872H						203 x 189 x 75	74.20.903.746
61.3900.100H						373 x 245 x 101	74.20.862.782
61.3900.110H						373 x 245 x 101	74.20.866.665
61.3900.120H						373 x 245 x 101	74.20.913.815 + 74.85.120.820
61.3900.130H						373 x 245 x 101	74.85.120.820
61.3910.110H						300 x 230 x 105	74.20.904.268
61.3910.120H						300 x 230 x 105	74.20.904.269
11.3900.100H						371 x 244 x 80	74.20.903.880
11.3910.110H						303 x 244 x 75	74.20.903.882
11.3910.120H						303 x 244 x 75	74.20.903.883
08.5752.024.099						130 x 120 x 53	74.20.866.672 + 74.20.862.812 74.21.618.499
09.3900.003.000						300 x 6 ø	74.21.614.025
20.3900.510H						518 x 160 x 98	50.10.623.057
20.3900.520H						518 x 160 x 98	50.10.623.058

Premium Route 2711 10/05 - 09/13

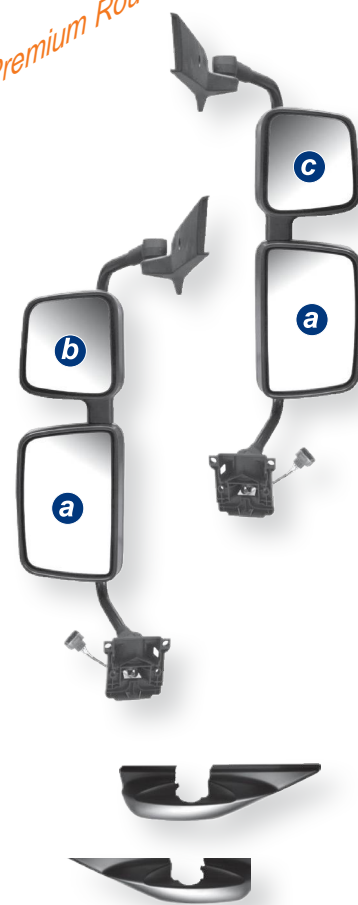

RENAULT

Premium Route 2711 10/05 - 09/13
 Midlum 1818 05/06 - 09/13
 Premium Distribution 05/06 - 09/13
 Kerax 10/13
 D-Serie 10/13
 C-Serie (2,3 m) 10/13

552-1	V VI [e1] 03★0033		ABS	INTEGR.
	V VI [E1] 020894			

MEKRA LANG Group	Beschreibung / description / descrição / descrizione / benámining / popis / опис / özeilik / leirás / opis					mm	OE
	Icons	Icons	Icons	Icons	Icons		
59.5524.648.099						725 x 319 x 126	74.20.849.837 + 74.82.226.025
51.5524.930H						316 x 186 x 77	74.21.020.285
59.5524.649.099						437 x 319 x 103	74.20.849.835 + 74.82.226.027
51.5524.930H						316 x 186 x 77	74.21.020.285



Premium, Gamme R/G
Midlum / Kerax → 09/2005



RENAULT			
348	II e1 03★0184 II (E1) 021022	Truck II ABS	Ø 22 mm
MEKRA LANG Group		mm	
Beschreibung description descriçãõ descriçione descripcion benamning popis omicaune üzellik leirás opis			OE
61.3481.149H		1	395 x 205 x 145 50.01.856.290
15.3480.840H			372 x 189 x 32
11.3480.100			169 x 88 x 27
61.3480.149H		2	382 x 193 x 85 50.01.853.675 • 50.01.856.292 50.01.833.026
40.3485.412H			375 x 190 x 3

RENAULT



RENAULT			
348	IV e1 03★0185 IV (E1) 021023	Truck IV ABS	Ø 22 mm
MEKRA LANG Group		mm	
Beschreibung description descriçãõ descriçione descripcion benamning popis omicaune üzellik leirás opis			OE
61.3482.149H			199 x 199 x 97 74.21.276.373
40.3485.403H			191 x 191 x 3



RENAULT			
558	V e1 03★0011 V (E1) 020912	Truck V ABS	
MEKRA LANG Group		mm	
Beschreibung description descriçãõ descriçione descripcion benamning popis omicaune üzellik leirás opis			OE
59.5580.247H			260 x 229 x 70 50.10.578.511
59.5580.147H			260 x 229 x 70



D-Serie
C-Serie (2,3 m) → 10/13 → 10/13



RENAULT			
1025	V e1 04★1345	Truck V ABS	
MEKRA LANG Group		mm	
Beschreibung description descriçãõ descriçione descripcion benamning popis omicaune üzellik leirás opis			OE
59.1025.001.099			315 x 179 x 220 7484531138
59.1025.002.099			315 x 179 x 220 7484531168

New Regulation ECE R46/04

SCANIA

400				INTEGR.
	Beschreibung description descripção descripziune benamning pops övrilikk leirás opis			
15.4001.840H		432 x 200 x 20	176 5985	
15.4001.740H		184 x 160 x 20	176 7265	

Komplettspiegel erhältlich bei SCANIA
complete mirror available at SCANIA

Serie 4 (NGS)
Serie R/P/T/G



95 - 07/04
08/04 →

08/04 →

Serie 4 R/P/T/G



2016 →

SCANIA

1005	V (E1) 04★1336 V (E1) 041336			
	Beschreibung description descripção descripziune benamning pops övrilikk leirás opis			
59.1005.003.099		326 x 202 x 214	2382791	

New Regulation ECE R46/04

Serie L/P/G



2016 →

1019	NEW	II (E1) 041391 IV (E1) 041392		
	Beschreibung description descripção descripziune benamning pops övrilikk leirás opis			
19.1019.013.099		400 x 208 x 29	2116845	
19.1019.014.099		400 x 208 x 29	2116846	
19.1019.313.099		219 x 196 x 39	2116848	
19.1019.314.099		219 x 196 x 39	2116849	

Serie L/P/G



1020		V (E1) 041389			INTEGR.
	Beschreibung description descripção descripziune benamning pops övrilikk leirás opis				
56.1020.020.099		307 x 279 x 95	2116023		
19.1020.213.099		297 x 172 x 62	2249381		
19.1020.613.099		297 x 172 x 62	2249382		
12.1020.003.099		191 x 137 x 41	2118477		
08.1024.124.099		130 x 120 x 45	3139595		

F7, F10, F12

12/77 - 08/85



250		II 01★14002				Ø 14-20 mm
MEKRA LANG Group		Beschreibung description descripção descripziune descripción benamining popis omicaune üzellik leirás opis				OE
51.2500.127H		375 x 183 x 26	1581 550			
40.2500.222H		366 x 176 x 3	1581 599			
51.2500.147H		375 x 183 x 26	1594 412 ♦ 1581 616 1594 411			
40.2500.422H		366 x 176 x 3	1581 602 ♦ 1594 415			
09.2070.101H		2070 x 9ø	2108 3541			

FL4, FL6, FL7, FL10
F10, F12, F16
NL10, NL12

09/85 - 9/94
09/85 - 9/93
1972 - 8/85



252		II 02★14089 II 0114089				Ø 14-20 mm
MEKRA LANG Group		Beschreibung description descripção descripziune descripción benamining popis omicaune üzellik leirás opis				OE
51.2520.127H		444 x 208 x 84	1599 462 ♦ 3090 395			
40.2520.222H		429 x 194 x 3	1697 007 ♦ 2085 4576			
51.2520.147H		444 x 208 x 84	1594 902 ♦ 1621 353 1195 934 ♦ 3090 396			
40.2520.422H		429 x 194 x 3	1697 008 ♦ 3093 519			
09.2070.101H		2070 x 9ø	2108 3541			

FH
FM
NH

10/93 - 03/02
08/98 - 03/02
05/99



370 371		II 02★14125 II 0114125				INTEGR.
MEKRA LANG Group		Beschreibung description descripção descripziune descripción benamining popis omicaune üzellik leirás opis				OE
15.3702.470H		433 x 198 x 16	3090 737 ♦ 3091 756 3092 854 ♦ 2085 4564			

FH I + FH II
FM I + FM II



360 360-1		V 02★12013 V 0112013 V 03★0039 V 020973				
MEKRA LANG Group		Beschreibung description descripção descripziune descripción benamining popis omicaune üzellik leirás opis				OE
59.3601.128H		284 x 174 x 62	1096 643			
40.3605.204F		272 x 162 x 3	3090 734 ♦ 2085 4583			
59.3601.178H		284 x 174 x 64	2120 3313			
40.3605.203H		272 x 162 x 3				
59.3601.188H		284 x 174 x 64				
40.3605.403H		272 x 162 x 3				
59.3602.128H		284 x 174 x 62	3126 117			
40.3605.204F		272 x 162 x 3	3090 734 ♦ 2085 4583			

VOLVO

390	II [e1] 03★0009			INTEGR.
	II (E) 020914			
	IV [e1] 03★0037			
	IV (E) 020916			

	Beschreibung description descripción descrizione beschreibung oírkucaíwe özetleírás opis	mm	OE

59.3900.143H		880 x 340 x 155	2020 7881 ♦ 2070 7881 2090 3722
59.3900.243H		880 x 340 x 155	2074 3983 ♦ 2132 6527
59.3900.133H		880 x 440 x 155	2070 7874
59.3900.233H		880 x 440 x 155	2070 8303 ♦ 2147 5603 2132 6526
59.3900.343		880 x 340 x 155	
59.3900.443		880 x 340 x 155	
59.3900.333		880 x 440 x 155	
59.3900.433		880 x 440 x 155	
15.3900.840H		337 x 202 x 25	2086 2795
15.3911.871H		200 x 197 x 75	2086 2810
15.3911.872H		200 x 197 x 75	2086 2815
61.3900.100H		373 x 245 x 101	2086 2782
61.3900.110H		373 x 245 x 101	2086 6665
61.3900.120H		373 x 245 x 101	
61.3900.130H		373 x 245 x 101	8512 0820
61.3911.110H		245 x 236 x 105	2086 2809
61.3911.120H		245 x 236 x 105	2086 2813
11.3900.200H		371 x 244 x 80	2086 2779
11.3910.200H		244 x 225 x 75	2086 2800
08.5752.024.099		130 x 120 x 53	2086 6672 ♦ 2086 2812 2161 8499
09.3900.003.000		300 x 6 ø	2161 4025
20.3900.510H		518 x 160 x 98	2070 8110
20.3900.520H		518 x 160 x 98	2070 8230

552-1	V VI [e1] 03★0033			INTEGR.
	V VI (E) 020894			

	Beschreibung description descripción descrizione beschreibung oírkucaíwe özetleírás opis	mm	OE

59.5524.648.099		725 x 319 x 126	2084 9837
51.5524.930H		316 x 186 x 77	2102 0285

09/2006

FL / FE

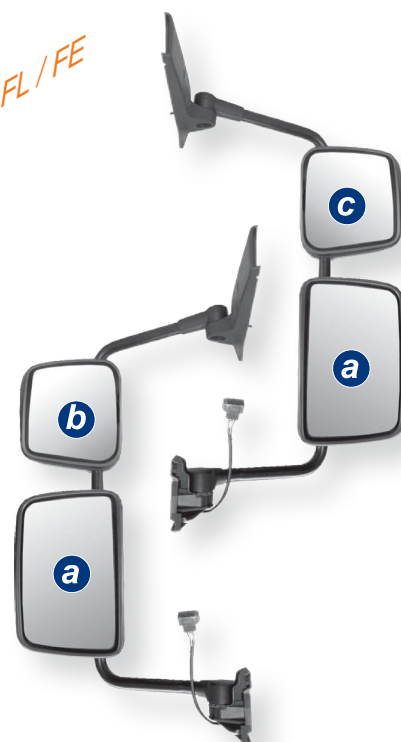

VOLVO

FL / FE



09/06

New Regulation ECE R46/04

VOLVO			
1025	V e1 04★1345	Truck V	ABS
MEKRA LANG Group		mm	
Beschreibung description descripção descripziune benämning popis omicaune úzeļļik leirás opis		OE	
59.1025.001.099		315 x 179 x 220	8453 1138
59.1025.002.099		315 x 179 x 220	8453 1168

FH 2 / FM 2



04/02 - 09/2012

224		Truck $\text{II} + \text{IV}$	ABS	INTEGR.
MEKRA LANG Group		mm		OE
Beschreibung description descripção descripziune benämning popis omicaune úzeļļik leirás opis				
15.2240.840H		431 x 197 x 30	2056 7670 + 2132 0383	

Komplettspiegel erhältlich bei VOLVO
complete mirror available at VOLVO

10/10 - 12/2015

FMX



572	$\text{II} \text{e1}$ 03★0031 $\text{II} \text{E1}$ 020918	Truck II	ASA	Ø 22 / 28 mm
MEKRA LANG Group		mm		OE
Beschreibung description descripção descripziune benämning popis omicaune úzeļļik leirás opis				
61.5721.006.099		426 x 200 x 135	8247 1690	
61.5721.005.099		426 x 200 x 135	8247 1688	
40.5725.412H		412 x 188 x 3	8241 7041	
61.5721.004.099		78 x 69 x 38	8247 2612	
11.5721.001.099		427 x 199 x 36	8241 7042	
08.5380.004.000		72 x 75 x 36		



573	$\text{IV} \text{e1}$ 03★0032 $\text{IV} \text{E1}$ 020917	Truck IV	ASA	Ø 22 / 28 mm
MEKRA LANG Group		mm		OE
Beschreibung description descripção descripziune benämning popis omicaune úzeļļik leirás opis				
61.5731.001.099		202 x 198 x 126	8247 1689	
40.5735.403H		190 x 184 x 3	8241 7044	
61.5721.004.099		78 x 69 x 38	8247 2612	
11.5731.001.099		202 x 198 x 27	8241 7045	

VOLVO

1000 1043/1044	II 041541	II 021108		ASA	INTEGR.
	II 041540	II 03★0242			
		II 021109			
		II 03★0243			

	Beschreibung description description descripção descripção benamning popis описанье özellik leirás opis		OE

51.1043.001.099		a	413x203x75	OE offers only components	MEKRA
51.1043.002.099		a	413x203x75	OE offers only components	
51.1044.001.099		b	204x209x88	OE offers only components	
51.1044.002.099		b	204x209x88	OE offers only components	
09.1000.200.099		1	250		
19.1043.001.099		a	406x199x40		
19.1044.001.099		b	199x204x54		
13.1043.001.000		a	413x203x47		
13.1044.001.000		b	204x209x54		
19.1000.101.099		c	387x205x41	82356810	
19.1000.121.099		2 c	387x205x41	24015370	
19.1000.102.099		d	387x205x41	82359214	
19.1000.122.099		2 d	387x205x41	24015373	
19.1000.103.099		e	205x205x55	82356824	
61.1000.004.099			130x127x65	23227102	

1 Anschlusskabel (Austausch) für Heizung ab Bj. 05/2019
heating cable for replacement for vehicles from 05/2019



VOLVO FH 4
VOLVO FMX
VOLVO FMD

10/12
10/15
2020

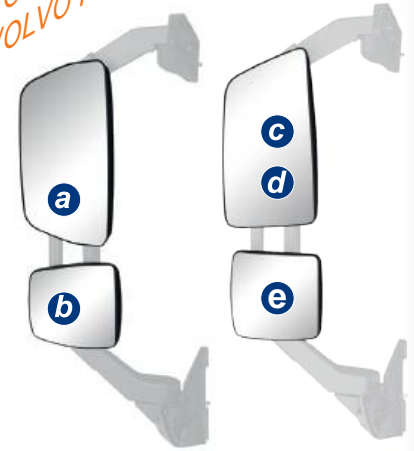

MEKRA OE

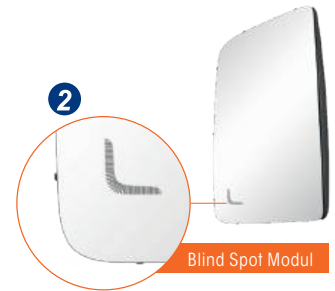

Das Blind Spot Modul ist im Lieferumfang nicht enthalten!
The Blind Spot Modul is not included in the delivery!

VW

349 349 TW	II e1 02★0384		ABS	INTEGR.
	II (E1) 010384			

	Beschreibung description description descripção descripção benamning popis описанье özellik leirás opis		OE

15.3491.071H			238x142x6	2D0 857 521	1 LT
15.3491.072H			238x142x6	2D0 857 522	
51.3495.112H			283x295x80	2D1 857 501 C 01C	2
15.3491.371H			238x142x6	2D0 857 521 A	
51.3495.122H			283x340x80	2D1 857 502 C 01C	
15.3491.372H			238x142x6	2D0 857 522 A	
56.3491.110H			175x116x70		
15.2711.214H			165x93x15		
56.3492.110H			175x116x70		
15.2711.214H			165x93x15		

01/96



Volkswagen
LT (Crafter)
05/2006 - 02/2017



589	II III e1 03★0006 II III E1 020902		ABS	INTEGR.
------------	---------------------------------------	---	-----	---------



mm







* mit beheizter Weitwinkel - Glaseinheit, nur verwendbar für Fahrzeuge ab "EURO 5" with heated wide angle mirror glass unit, suitable from "EURO 5" vehicles only

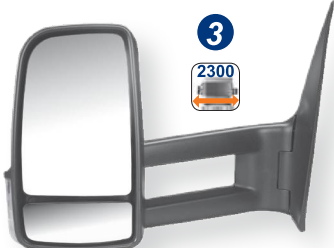

		Beschreibung description description description benamning popsis ömrcauwe ბრელიკ reírás opis				
L H D	1	51.5891.111.199		344 x 315 x 182 2E1 857 501 E 2E1 857 501 AJ		
		51.5891.112.199 *		344 x 315 x 182 2E1 857 501 Q		
		51.5891.113.199		344 x 315 x 182 2E1 857 501 F		
		51.5891.114.199 *		344 x 315 x 182 2E3 857 501 J		
		51.5894.112.199 *		344 x 315 x 182 2E0 857 513 C		
		R H D	1	51.5891.311.199		344 x 345 x 182 2E2 857 501 C 2E2 857 501 N
				51.5894.310.199		344 x 345 x 182 2E0 857 513 B
				51.5891.312.199 *		344 x 345 x 182 2E2 857 501 F
				51.5891.313.199		344 x 345 x 182 2E2 857 501 D
51.5891.314.199 *		344 x 345 x 182 2E4 857 501 K				
L H D	2	51.5891.211.199		344 x 345 x 182 2E1 857 502 E 2E1 857 502 AK		
		51.5891.212.199 *		344 x 345 x 182 2E1 857 502 P		
		51.5891.213.199		344 x 345 x 182 2E1 857 502 F		
		51.5891.214.199 *		344 x 345 x 182 2E3 857 502 K		
		51.5894.212.199 *		344 x 345 x 182 2E0 857 514 B		
		R H D	2	51.5891.411.199		344 x 315 x 182 2E2 857 502 C 2E2 857 502 N
				51.5894.410.199		344 x 315 x 182 2E0 857 514 A
				51.5891.412.199 *		344 x 315 x 182 2E2 857 502 F
				51.5891.413.199		344 x 315 x 182 2E2 857 502 D
51.5891.414.199 *		344 x 315 x 182 2E4 857 502 L				
L H D	3	51.5892.111.199		344 x 509 x 182 2E3 857 501 D 2E1 857 501 AK		
		51.5892.112.199 *		344 x 509 x 182 2E1 857 501 R		
		51.5892.113.199		344 x 509 x 182 2E3 857 501 F		
		R H D	3	51.5892.311.199		344 x 460 x 182 2E4 857 501 D 2E4 857 501 AD
				51.5892.312.199 *		344 x 460 x 182 2E2 857 501 G
				51.5892.313.199		344 x 460 x 182 2E4 857 501 F
				51.5895.312.199 *		344 x 460 x 182 2E4 857 513 B
		L H D	3	51.5892.211.199		344 x 460 x 182 2E1 857 502 D 2E1 857 502 AL
				51.5892.212.199 *		344 x 460 x 182 2E1 857 502 Q
51.5892.213.199				344 x 460 x 182 2E3 857 502 F		
51.5892.411.199				344 x 509 x 182 2E4 857 502 E		
51.5892.413.199				344 x 509 x 182 2E4 857 502 G		
51.5895.412.199 *		344 x 509 x 182 2E4 857 514 B				
L H D	3	51.5893.111.199		344 x 543 x 182 2E3 857 501 E 2E1 857 501 AL		
		51.5893.112.199 *		344 x 543 x 182 2E3 857 501 H		
		51.5893.113.199		344 x 543 x 182 2E3 857 501 G		
		51.5893.211.199		344 x 511 x 182 2E3 857 502 E 2E1 857 502 AM		
		51.5893.212.199 *		344 x 511 x 182 2E3 857 502 J		
		51.5893.213.199		344 x 511 x 182 2E3 857 502 G		



589	II III e1 03★0006		
	II III E1 020902		

	Beschreibung description descripção descrizione descripção benamining Pops omrcauwe betriks opis		OE
--	---	--	----

15.5891.741H		236 x 155 x 16	2E1 857 587	a
15.5891.742H		236 x 155 x 16	2E1 857 588	
15.5891.611H		154 x 59 x 19	2E1 857 587 A	b
15.5891.612H		154 x 59 x 19	2E1 857 588 A	
19.5890.011.099		240 x 158 x 21	2E0 857 587 A	c
19.5890.012.099		240 x 158 x 21	2E0 857 588 A	
19.5891.011.099		240 x 158 x 21	2E0 857 587 B	
19.5891.012.099		240 x 158 x 21	2E0 857 588 B	
08.5890.300.099		113 x 32 x 15	2E0 919 473	
08.5890.301.099		113 x 32 x 15	2E0 919 473 A	
15.5891.721.099		157 x 65 x 20	2E1 857 587 E	d
15.5891.722.099		157 x 65 x 20	2E1 857 588 E	
13.5890.110.199		344 x 218 x 82	2E1 857 516 A	
13.5890.210.199		344 x 218 x 82	2E1 857 516 B	
13.5890.120.099		344 x 201 x 82	2E0 857 527	
13.5890.220.099		344 x 201 x 82	2E0 857 528	
14.5890.100.099		337 x 192 x 56	2E1 857 136	
14.5890.200.099		337 x 192 x 56	2E1 857 136 A	
08.5892.001.099		13 133 x 118 x 88	2E0 953 049 A + 2E0 945 981	
08.5892.002.099		13 133 x 118 x 88	2E0 953 049 C + 2E0 945 981	
08.5892.003.099		13 133 x 118 x 88	2E0 953 050 A or 2E0 953 050 C + 2E0 945 981	
08.5892.004.099		13 133 x 118 x 88	2E0 953 050 B or 2E0 953 049 B + 2E0 945 981	
08.5892.105.099		12 51 x 27 ø	2E0 945 981	

05/06 - 09/09

Volkswagen
LT (Crafter)



a



b

10/2009

Volkswagen
LT (Crafter) EURO 5 + 6



c



d



VW

Volkswagen NF (Crafter) 08/2017



1013	NEW	II (E1) 041427			INTEGR.
-------------	------------	----------------	---	---	----------------



Beschreibung
description
descripção
descripção
benamining
popsis
omicaame
bœeilik
letrās
opis























































































































1









2

LHD	1	59.1013.116.199	   			384 x 330 x 257	7C1857387FP * 7C1857387ES 5, 14, 16, 20, 23, 24, 27 *	
		59.1013.117.199	    			384 x 330 x 257	7C1857387FJ * 7C1857387FC 1, 5, 12, 14, 16, 20, 23, 24, 25, 27 *	
		59.1013.216.199	   			384 x 309 x 314	7C1857388EG * 7C1857388DK 6, 15, 17, 21, 22, 24, 25, 29 *	
		59.1013.101.199	     			384 x 330 x 257	7C1857387FT * 7C1857387ET 4, 5, 14, 16, 18, 23, 27 *	
		59.1013.109.199	     			384 x 330 x 257	7C1857387FK * 7C1857387FD 1, 4, 5, 12, 14, 16, 18, 23, 27 *	
		59.1013.201.199	    			384 x 309 x 314	7C1857388EH * 7C1857388DL 4, 6, 15, 17, 19, 22, 25, 29 *	
		59.1013.212.199	     			384 x 309 x 314	7C1857388EC * 7C1857388DQ 2, 3, 4, 6, 13, 15, 17, 19, 22, 25, 29 *	
		59.1013.102.199	     			384 x 330 x 257	7C1857387FR * 7C1857387FB 4, 5, 14, 16, 18, 23, 26 *	
		59.1013.106.199	     			384 x 330 x 257	7C1857387FM * 7C1857387FF 1, 4, 5, 12, 14, 16, 18, 23, 26 *	
		59.1013.202.199	     			384 x 309 x 314	7C1857388EK * 7C1857388DN 4, 6, 15, 17, 19, 22, 25, 28 *	
	RHD		59.1013.316.199	   			384 x 309 x 314	7C2857387CR * 7C2857387CG 10, 14, 16, 20, 23, 24, 25, 30 *
			59.1013.317.199	    			384 x 309 x 314	7C2857387CN * 7C2857387CJ 1, 10, 12, 14, 16, 20, 23, 24, 25, 30 *
			59.1013.416.199	   			384 x 330 x 257	7C2857388CB * 7C2857388BL 11, 15, 17, 21, 22, 24, 25, 31 *
			59.1013.301.199	    			384 x 309 x 314	7C2857387CS * 7C2857387CH 4, 10, 14, 16, 18, 23, 25, 30 *
			59.1013.309.199	     			384 x 309 x 314	7C2857387CP * 7C2857387CK 1, 4, 10, 12, 14, 16, 18, 23, 25, 30 *
		59.1013.401.199	    			384 x 330 x 257	7C2857388CC * 7C2857388BM 4, 11, 15, 17, 19, 22, 25, 31 *	
		59.1013.412.199	     			384 x 330 x 257	7C2857388BT * 7C2857388BP 2, 3, 4, 11, 13, 15, 17, 19, 22, 25, 31 *	
LHD		2	59.1013.501.199	    			384 x 434 x 191	7CB857387BE v 7CB857387BA 4, 5, 14, 16, 18, 23, 25, 32 *
			59.1013.509.199	     			384 x 434 x 191	7CB857387BC v 7CB857387AT 4, 5, 7, 12, 14, 16, 18, 23, 25, 32 *
		59.1013.601.199	    			384 x 434 x 238	7CB857388AL v 7CB857388AJ 4, 6, 15, 17, 19, 22, 25, 33 *	
		59.1013.612.199	     			384 x 434 x 238	7CB857388AN v CB857388AG 4, 6, 8, 9, 13, 15, 17, 19, 22, 25, 33 *	

* Der Komplettspiegel besteht aus den aufgelisteten Positionen.
Die Zuordnung zu den entsprechenden Artikelnummern befindet sich auf der rechten Seite.
The complete mirror consists of the items listed.
The allocation to the corresponding article number is on the right-hand side.



1013	NEW	II (E1) 041427			INTEGR.
		 mm		OE	
Beschreibung description description description benámení Pops описание bireklit opis					
19.1013.011.099		a	211 x 169 x 19	7C0 857 521 D 7C0 857 521 G	
19.1013.012.099		b	211 x 169 x 19	7C0 857 522 A 7C0 857 522 F	

Volkswagen NF (Crafter) 2017 



Pos.	MEKRA	VW	FM	LTE	GNSS	Bluetooth	UWB	U	Phone	Camera	Wrench	Rumpfspiegel - carcase
1	08.1013.007.000	7C0 035 532										
2	08.1013.008.000	7C0 035 534										
3	08.1013.009.000	7C0 035 540										
4	08.1013.010.000	7C0 959 578										
5	08.1013.012.100	7C1 949 101 B										
6	08.1013.013.100	7C1 949 102 B										
7	08.1013.107.000	7C0 035 532 A										
8	08.1013.108.000	7C0 035 534 A										
9	08.1013.109.000	7C0 035 540 A										
10	08.1013.712.100	7C2 949 101 B										
11	08.1013.713.100	7C2 949 102 B										
12	11.1013.015.000	7C0 035 981										
13	11.1013.016.000	7C0 035 981 A										
14	13.1013.001.000	7C0 857 527										
15	13.1013.002.000	7C0 857 528										
16	13.1013.003.000	7C0 857 603 A										
17	13.1013.004.000	7C0 857 604 A										
18	19.1013.011.004	7C0 857 521 G										
19	19.1013.012.004	7C0 857 522 F										
20	19.1013.411.004	7C0 857 521 F										
21	19.1013.412.004	7C0 857 522 E										
22	61.1013.002.004	7C0 898 554										
23	61.1013.003.004	7C0 898 553										
24	61.1013.001.004	2E0 857 049										
25	61.1013.005.004	7C0 898 011										
26	61.1013.103.004	7C1 857 407 L										
27	61.1013.116.004	7C1 857 407 J										
28	61.1013.203.004	7C1 857 408 L										
29	61.1013.216.004	7C1 857 408 J										
30	61.1013.316.004	7C2 857 407 G										
31	61.1013.416.004	7C2 857 408 G										
32	61.1013.501.004	7CB 857 407 C										
33	61.1013.601.004	7CB 857 408 C										

UNIVERSAL

385

II e1 02★0469

I (E1) 010469



ABS

① Ø 14-20 mm

② Ø 20-30 mm

MEKRA
LANG GroupBeschreibung
description
descripção
descripção
benämning
popis
omicaune
üzellik
leirás
opis

OE

51.3850.127H		①	314 x 228 x 65	G 297.810.150.030 (Fendt) AL 158964 (John Deere)
51.3850.227		②	314 x 228 x 65	00437650 (Case New Holland)
40.2890.222H			300 x 214 x 3	F 297 810 150 010 (Fendt)
51.3850.137		①	314 x 228 x 65	
40.2890.322			300 x 214 x 3	
10.6211.100			282 x 162	
09.2000.301H			2000 x 9 ø	
51.3850.147H		①	314 x 228 x 65	Y07001023 (KFB) HJ24013370 (VDL)
51.3850.247		②	314 x 228 x 65	8.688.100.000.0 (Kässbohrer)
40.2890.422H			300 x 214 x 3	
10.6221.100			282 x 162	
09.2000.301H			2000 x 9 ø	
51.3850.157		①	314 x 228 x 65	
40.2890.322			300 x 214 x 3	
10.6211.100			282 x 162	
51.3850.167H		①	314 x 228 x 65	D072143 (Bredamenarini)
51.3850.197H		①	314 x 228 x 65	2097 0652 (Volvo)
51.3850.267		②	314 x 228 x 65	33.63730-6001 (MAN) D072143 (Bredamenarini)
40.2890.422H			300 x 214 x 3	
10.6221.100			282 x 162	001 821 00 29 (Mercedes) 8.688.041.029.0 (Setra) 1905 564 00 (Neoplan) 161.00.77.2027 (MAN Steyr)
09.3400.420			2000	

Agriculture
Case New Holland, Fendt,
John Deere, Kässbohrer, KFB etc.



* Variante mit 2 Steckern für beheizbare Zusatzspiegel
version with 2 plug sockets for mounting additional heated mirrors

UNIVERSAL

universal Rampenspiegel

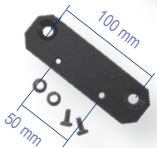

552-1

V VI e1 03★0033

V VI (E1) 020894



ABS

MEKRA
LANG GroupBeschreibung
description
descripção
descripção
benämning
popis
omicaune
üzellik
leirás
opis

OE

59.5520.530H			319 x 187 x 77	1525 537 (DAF) 105137C (Plaxton)
--------------	--	--	----------------	-------------------------------------

UNIVERSAL

300				① Ø 30 mm ② Ø 35 mm
	Beschreibung description descripção descripzione description benamning popis описання őzellik leírás opis			
55.3000.001.001				Ø 306 x 96
55.3000.003.001				Ø 306 x 96
55.3000.002.001				Ø 306 x 88
55.3000.004.001				Ø 306 x 88
51.3000.001.001				Ø 306 x 96
51.3000.002.001				Ø 306 x 88 2401 8790 (Volvo) 3070159 (SCANIA)
61.3000.003.010				47 x 48 x 260
61.3000.004.010				47 x 48 x 260 2401 8822 (Volvo) 3070160 (SCANIA)

Innenspiegel Busse
EvoBus, Göppel, Hess, Neoplan,
Scania, VDL, Volvo



750	NEW				INTEGR.
	Beschreibung description descripção descripzione description benamning popis описання őzellik leírás opis				
51.7504.044.001				301 x 141	2320 0690 (Volvo)
20.7504.044.001				230	2328 6290 (Volvo)
20.7504.003.001				71	2328 6294 (Volvo)

Innenspiegel



552-1	V VI 03★0033 V VI 020894				INTEGR.
	Beschreibung description descripção descripzione description benamning popis описання őzellik leírás opis				
59.5524.530H				418 x 492 x 77	27230912 (Terex)
51.5524.930H				316 x 186 x 77	

universal Frontspiegel

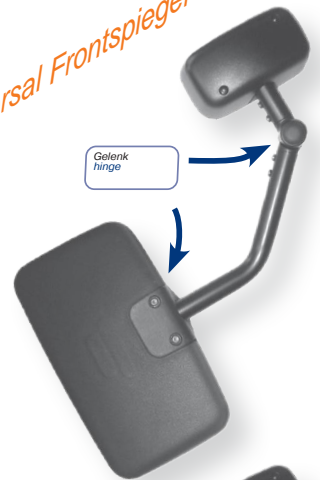

Gelenk
hinge

389	VI 03★0016 VI 020937				INTEGR.
	Beschreibung description descripção descripzione description benamning popis описання őzellik leírás opis				
59.3891.140H				397 x 557 x 92	
51.3894.140H				Ø 259 x 92	



Montagevarianten
mounting possibilities
possibilités de montage
possibilidades de montagem
variante del montaggio
possibilidades de montaje
monteringsmögijgheter
Montážni varianty
Виды монтажа
montaj montaj olasılikları
különböző kivitelek
Możliwości montażu

A Dach
roof
pavillon
teto
tetto
techo
tak
střecha automobilu
Крышы автомобиля
kabin üstü
tetöre szerelt
Dach

B A-Säule
A-pillar
montant
pilar A
pilastro A
pilar A
A - stolpe
A - sloupek
A - obr. stolb
A - sütunu
A oszlopra szerelt
Stupek

UNIVERSAL AGRICULTURE

152 ASKB

II e1 14010



Ø 10 / 12 / 13 mm

MEKRA
LANG GroupBeschreibung
description
descripção
descripziune
benamning
popis
omicaewie
bzeiljik
leirras
opis

OE

51.1524.119H



260 x 149 x 22

E 178.810.150.019 (Fendt)
E 178.810.150.010 (Fendt)
F 178.810.150.020 (Fendt)
000 811 68 33 (Mercedes)
639 153 (Scania)

40.1525.114H



252 x 141 x 3

diverse Traktoren / various tractors



289



Ø 16-18 mm

MEKRA
LANG GroupBeschreibung
description
descripção
descripziune
benamning
popis
omicaewie
bzeiljik
leirras
opis

OE

51.2890.117H



310 x 220 x 25

G 816.810.150.030 (Fendt)
161 0077 0103 (MAN Steyr)
81.63730-6170 (MAN)

40.2890.222H



300 x 214 x 3

F 297 810 150 010 (Fendt)

51.2890.147H



310 x 220 x 25

40.2890.422H



300 x 214 x 3

10.6221.100



282 x 162

09.2070.101H



2070 x 9ø

10342167 (Liebherr)
11182172 (Liebherr)Steyr Trucks
Steyr- + KHD Traktoren

363

II e1 03★0022

II (E1) 020905



Ø 18-28 mm

MEKRA
LANG GroupBeschreibung
description
descripção
descripziune
benamning
popis
omicaewie
bzeiljik
leirras
opis

OE

51.3635.201



384 x 205 x 120

290-5544 (Caterpillar)
319-6789 (Caterpillar)
270011780 (Krone)

51.3636.201



384 x 205 x 120

290-5545 (Caterpillar)
319-6788 (Caterpillar)

51.3635.204



384 x 205 x 120

294-1991 (Caterpillar)
316-6791 (Caterpillar)

51.3636.204



384 x 205 x 120

294-1992 (Caterpillar)
319-6790 (Caterpillar)

15.3802.840H



368 x 189 x 40

8.688.105.263.0 (Kässbohrer)
11312890 (Krauss-Maffei)
10470601 (Liebherr)
AP105367C-3 (Plaxton)
990115703000 (Tatra)
48092012 (Terex)

51.3635.206



384 x 205 x 120

688 645 (Fritzmeier)
8.688.105.000.0 (Kässbohrer)
443332051000 (Tatra)

51.3636.206



384 x 205 x 120

688 646 (Fritzmeier)
8.688.106.000.0 (Kässbohrer)
443332052000 (Tatra)

15.3802.840H



368 x 189 x 40

siehe oben / see above

11.3730.210H



367 x 187 x 60

84434473 (CNH)

DEMAG, Caterpillar



UNIVERSAL AGRICULTURE

1009	II (E1) 021165			Ø 18-22 mm Ø 28 mm *
-------------	----------------	--	--	-------------------------

	Beschreibung description description description benamming pops описание betrijfs ops		
--	---	--	--

51.1009.017.099		382 x 232 x 122	372-8075 (Caterpillar) 26143870 (Class) G304810150020 (Fendt) ACV0805960 (Fendt/Valtra) 42154H3480 (Komatsu) 21D-54-41710 (Komatsu) 1000386860 (Kramer) 11068341 (Liebherr) 3010662 (Lindner) 17452496 (Volvo)
51.1009.027.099		382 x 232 x 122	436-2886 (Caterpillar)
51.1009.149.099		382 x 232 x 122	1000390196 (Kramer) 11181691 (Liebherr) 21971360 (Claas)
51.1009.097.099		382 x 232 x 122	1000396281 (Kramer) ACV0148490 (Valtra) 3728076-03 (Carwall)
51.1009.025.099		382 x 232 x 122	ACV0148490 (Fendt) 42154H3380 (Komatsu) 16281990 (Volvo)
51.1009.029.001		382 x 232 x 122	
51.1009.031.001		382 x 232 x 122	
51.1009.045.001		382 x 232 x 122	
51.1009.047.001		382 x 232 x 122	

51.1009.021.099		465 x 231 x 143	26095630 (Claas) G743810150010 (Fendt) 3010850 (Lindner) G743810150020 (Fendt)
51.1009.022.099		465 x 231 x 143	26096000 (Claas) 1000379630 (Kramer) 3010851 (Lindner)
51.1009.121.099		465 x 231 x 143	3010852 (Lindner)
51.1009.122.099		465 x 231 x 143	1000379641 (Kramer) 3010853 (Lindner)

51.1009.242.099		Ø 28 mm	436-2887 (Caterpillar)
09.2000.301H		2000 x 9 Ø	11181692 (Liebherr)
09.3200.420H		42 x 42 x 54 [2000]	6.200.26.176 (Mauser)

a	51.1009.001.099		291 x 232 x 121	526-5057 (Caterpillar) 3010115 (Lindner) 2186303 (Wirtgen)
	51.1009.081.099		291 x 232 x 121	3010188 (Lindner)
	51.1009.113.099		291 x 232 x 121	22332170 (Claas) AKK34593 (John Deere)
	51.1009.009.099		291 x 232 x 121	545541 (Miller)
	40.1009.001.000		285 x 225 x 2	5653634836 (Terex) F743810150010 (Fendt)
	40.1009.004.099		285 x 225 x 2	ACV0759270 (Fendt/ Valtra) 3205677 (Lindner)
	40.1009.001.099		285 x 225 x 2	
b	51.1009.049.099		190 x 109 x 18	
	40.1009.002.000		178 x 92 x 2	5653634837 (Terex) F304810150030 (Fendt)
	40.1009.002.099		178 x 92 x 2	11578550 (Claas) ACV0759280 (Valtra)
	40.1009.005.099		178 x 92 x 2	166352077 (SIAC)
c	61.1009.001.099		196 x 188 x 42	11654110 (Claas)
	61.1009.002.099		196 x 188 x 42	11654120 (Claas)
	40.1009.421.002		180 x 170 x 2	F743810150020 (Agco) 11653140 (Claas)
	40.1009.422.002		180 x 170 x 2	F749810150030 (Agco) 11653170 (Claas)
d	40.1009.003.099		202 x 138 x 3	

Große Traktoren
large tractors

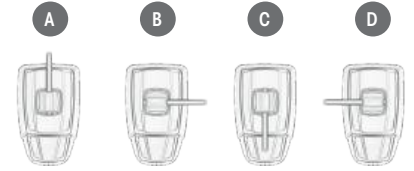

Rohranbindung
mounting position arm



1 Haupt- und Nahbereichsspiegel
Main and close proximity mirror



2 Hauptspiegel mit großen
Nahbereichsspiegel für
Traktoren ISO 5721-2
Main - and large close proximity
mirror for tractors ISO 5721-2



3 Hauptspiegel mit großen
Nahbereichsspiegel für
Radbagger ISO14401-2
Main - and large close proximity
mirror for Wheel excavator
ISO14401-2

UNIVERSAL AGRICULTURE

*Kleine Traktoren
small tractors*



1010	II (E1) 021228			Ø 14 - 20 mm
	Beschreibung description descripción descripção descripzione benámenning popis opis opis			
51.1010.010.001		284 x 176 x 90	R561145311 (Kubota)	
40.1010.002.099		278 x 169 x 2		

*Teleskopstange
telescopic bracket*

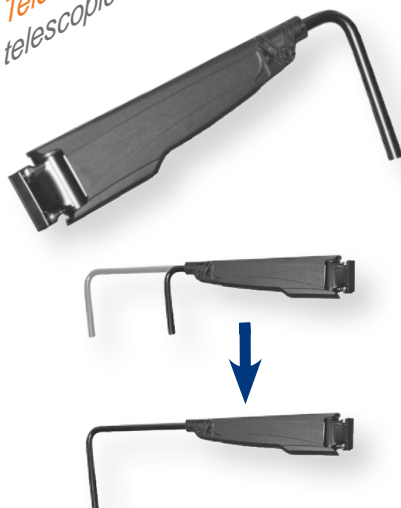

1017				Ø 22 mm
	Beschreibung description descripción descripção descripzione benámenning popis opis opis			
58.1017.005.099		510 - 800 Teleskop	G-530810150010 (AGCO)	
58.1017.006.099		510 - 800 Teleskop	G-530810150020 (AGCO)	
58.1017.013.099		510 - 800 Teleskop		
58.1017.014.099		510 - 800 Teleskop		
58.1017.011.099		510 - 800 Teleskop	3009961 (Lindner)	
58.1017.012.099		510 - 800 Teleskop	3009999 (Lindner)	
58.1017.015.099		510 - 760 Teleskop		
58.1017.016.099		510 - 760 Teleskop		

UNIVERSAL



1038	NEW	II (E1) 051696			Ø 22 mm
	Beschreibung description descripción descripção descripzione benámenning popis opis opis				
51.1038.003.099		359 x 178 x 89			
51.1038.004.099		359 x 178 x 89			
58.1038.003.099		554 - 804 Teleskop	30331340 (Claas)		
58.1038.004.099		554 - 804 Teleskop	30331350 (Claas)		
a	40.1038.411.099		234 x 166 x 2		
	40.1038.412.099		234 x 166 x 2		
b	40.1038.751.099		162 x 125 x 2		
	40.1038.752.099		162 x 125 x 2		

*Werkzeuglos verstellbar von vertikal zu horizontal
Adjustable from vertical to horizontal without tools*

UNIVERSAL AGRICULTURE

1036

II (E1) 041459



Ø 22 mm



Beschreibung
description
descripção
descrizione
description
benamining
popsis
описание
birelik
letras
opts



OE

51.1036.021.099		487 x 228 x 130		1
51.1036.022.099		487 x 228 x 130		
51.1036.023.099		487 x 228 x 130	26079370 (Claas) 47826941 (CNH)	
51.1036.024.099		487 x 228 x 130	26079500 (Claas) 47904843 (CNH)	
51.1036.025.099		487 x 228 x 130	6-200.26.185 (Mauser)	
51.1036.026.099		487 x 228 x 130		
11.1036.011.099		153 x 144 x 45	11617700 (Claas) 51487075 (CHN) R566924 (John Deere)	
11.1036.012.099		153 x 144 x 45	11617720 (Claas) 51487076 (CNH)	
51.1036.007.099		487 x 228 x 130	47922743 (CNH)	2
51.1036.008.099		487 x 228 x 130	47922744 (CNH)	
51.1036.009.099		487 x 228 x 130	47922739 (CNH) AL232743 (John Deere)	
51.1036.010.099		487 x 228 x 130	47922741 (CNH) AL232744 (John Deere)	
11.1036.013.099		153 x 144 x 45	48025212 (CNH) L221136 (John Deere)	
11.1036.014.099		153 x 144 x 45	48025217 (CNH) L221137 (John Deere)	
19.1036.005.099		299 x 202 x 24	48025196 (CNH)	
19.1036.006.099		177 x 190 x 14	48025209 (CNH)	
19.1036.007.099		299 x 202 x 24	11617730 (Claas) 48025195 (CNH) AL225823 (John Deere)	
19.1036.008.099		177 x 190 x 14	11617740 (Claas) 48025204 (CNH) AL225824 (John Deere)	
19.1036.009.099		299 x 202 x 24		
19.1036.010.099		177 x 190 x 14		
09.3200.420H		42 x 42 x 54 [2000]		

Große Traktoren
large tractors



1

Vertikale Rohranbindung
Mounting to vertical tube



2

Horizontale Rohranbindung
Mounting to horizontal tube



UNIVERSAL MOTOR HOMES

1018

II (E1) 021281

IV (E1) 021282



INTEGR.

MEKRA
LANG Group

Beschreibung
description
descripção
descrizione
description
benamning
popis
omrcaune
brevlik
leirats
opis



OE

BÜRSTNER Grand Panorama 2012
 CARTHAGO Chic 2012
 EURA MOBIL Integra 2012
 CONCORDE, Plaxton, Hymer



1	59.1018.003.099		673 x 245 x 327	284260 (Concorde)
	59.1018.004.099		673 x 245 x 327	284261 (Concorde)
	12.1018.003.099		182 x 64 x 61	
2	59.1018.007.099		699 x 245 x 406	2276379 (Bürstner)
	59.1018.008.099		699 x 245 x 406	207193 (Carthago)
	12.1018.005.099		262 x 64 x 64	
3	59.1018.001.099		727 x 245 x 480	200070726B (Eura Mobil)
	59.1018.002.099		727 x 245 x 480	200070727B (Eura Mobil)
	12.1018.007.099		345 x 64 x 67	2193841 (Bürstner) 201621 / 201622 (Carthago)
	12.1018.001.099		517 x 197 x 70	2193829 (Bürstner) 201619 (Carthago) 2203 3845 (Volvo)
	12.1018.002.099		517 x 197 x 70	2193831 (Bürstner) 201620 (Carthago) 2203 3846 (Volvo)
	15.2780.841F		307 x 177 x 22	8034580 (Hymer)
	19.1018.311.099		178 x 142 x 34	
	19.1018.312.099		178 x 142 x 34	
	12.1018.009.001		226 x 116 x 85	2193839 (Bürstner) 284265 (Concorde) 207195 (Carthago) 175202B-9 (Plaxton)
	12.1018.010.001		226 x 116 x 85	2193840 (Bürstner) 284266 (Concorde) 207196 (Carthago) 175202B-8 (Plaxton)
	09.2910.005.099		3550 x 6 ø	2218519 (Bürstner) 200070749 (Eura Mobil)
	09.2910.002.099		6050 x 6 ø	2218516 (Bürstner) 200070751 (Eura Mobil) 2203 8103 (Volvo)
	08.3200.233H		42 x 42 x 54	200607013 (Bürstner) 112228 (Carthago) 200070818 (Eura Mobil) 1449696 (Hymer) 2092 5244 (Volvo)

a Haltefußabdeckung
cover retaining foot



b Tragarmschale oben
up cover support shaft



c Spiegelkopfabdeckung
mirror head cover

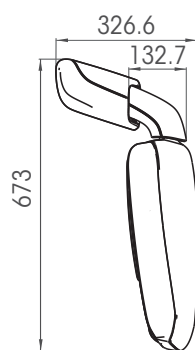

kurz
short ①

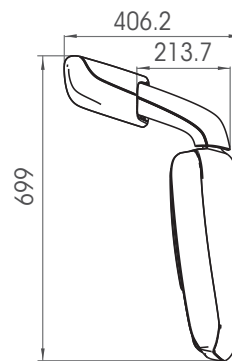

mittel
middle ②

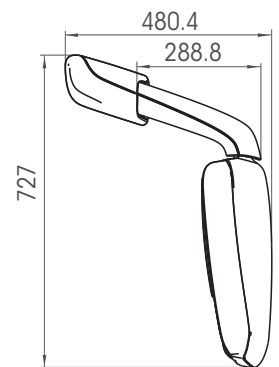

lang
long ③

UNIVERSAL COACHES

271		II e1 02★0524 II (E1) 010524		Truck II ABS PU		A	
MEKRA LANG Group		Beschreibung description descripção descrizione benamining popsis описанье leirats opis		mm		OE	
59.2710.401H		703 x 783 x 212	284230 (Concorde) 53-707213-710401 (Merkavim) AA-01976 (Plaxton) P758200126 (VDL) 8350 042502 * 7032 8278 (Volvo)	1			
51.3731.326		384 x 205 x 116	50.06.232.483 (Irisbus) 17294289-0 (Marcopolo) 53-707127-731326 (Merkavim) PAA-01976-1 (Plaxton) 189 3532 (Scania) 1905 503 00 (Solaris) 30022423 (VDL) 7030 9627 * 8706 2719 00059 (Volvo) 8350 035653 (Volvo)				
59.2710.402H		701 x 641 x 200	1251 2071 (Carrus) 284232 (Concorde) 53-707213-710402 (Merkavim) 30017729 (VDL) 7302 8283 (Volvo)	2			
51.3732.326		384 x 205 x 116	D072145 (Bredamenarini) 7036 9682 (Carrus) 50.06.232.482 (Irisbus) 17294289-0 (Marcopolo) PAA-01977-1 (Plaxton) 180 5203 * 189 5048 (Scania) 1905-502-00 (Solaris) 8706 2719 00060 (Volvo) 8350 035654 (Volvo)				
59.2710.454		701 x 801 x 200	083895B (Plaxton)	3			
51.3731.326		384 x 205 x 116	siehe oben / see above				
59.2710.406		701 x 746 x 200	284233 (Concorde) AA-01977 (Plaxton)	4			
51.3732.326		384 x 205 x 116	siehe oben / see above				
15.3731.470H		368 x 189 x 40	284248 (Concorde) 425 562 28 (Iveco) PAA-01976-2 (Plaxton) 150 5201 (Scania) 1905 731 470 (Solaris) 30017741 (VDL) 8706 2719 00030 (Volvo)	a			
15.2711.114		165 x 93 x 25	284226 (Concorde) 42545988 (Irisbus) 001 810 60 16 (Mercedes) PAA-01976-3 (Plaxton) 8355 0046556 (Volvo)	b			
15.2712.114		152 x 128 x 23	284228 (Concorde) 42545989 (Irisbus) 001 810 61 16 (Mercedes) PAA-01977-4 (Plaxton) 8350 046557 (Volvo)	c			
15.2712.113F		152 x 128 x 23	7030 60536 (Volvo)	d			
11.3730.210H		367 x 187 x 60	84434473 (CNH) 425 459 90 * 425 562 27 (Iveco) 150 5202 (Scania) 17294287-7 (Marcopolo) 8706 2719 00052 (Volvo) 1905 770 210 (Solaris)				
20.2700.200H		126 x 25 Ø	1299452 (Hymer)				
20.2710.200H*		183 x 181 x 84	17294281 (Marcopolo) AA-01978 * AA-01979 (Plaxton) 7036 0530 * 8350 046433 (Volvo)				
20.2710.111H		183 x 145 x 107	09-37986101-8 (Marcopolo) 8706 2719 00020 (Volvo) 8350 046970 (Volvo)				
20.2710.121		183 x 145 x 107	09-37986101-8 (Marcopolo) 7032 8290 * 033 1121 (Volvo)				
20.2480.213		108 x 50 x 15 [800]	356 810 06 11 (Mercedes) AA-01980 * AA-01981 (Plaxton)				
20.2480.216H		108 x 50 x 15 [2000]	284240 (Concorde) 83.63731-6507 (MAN) 53-750610-208091 (Merkavim) 145 1226 (Scania) 1970-018-000 (Solaris) P759001645 (VDL) 7033 1124 * 8350 046971 (Volvo)				
20.2480.217H		108 x 50 x 15 [5000]	284242 (Concorde) 425 459 85 (Iveco) 81.63731-6470 (MAN) P107424C-10 (Plaxton) 53-707213-480217 (Merkavim) P759001646 (VDL) 7033 1123 7034 8002 (Volvo) 8706 2719 00018 (Volvo) 8350 046432 (Volvo)				

Reisebusse / Coaches:
 Avtobus, BMC, Concorde, Dallavia,
 EvoBus, Euro Coach, Hymer,
 Ikarbus, Irisbus, Marcopolo, MAZ,
 LAZ, Plaxton, TEMSA, Tovarna,
 VDL, Volvo (7500 DD, 7700, 8700,
 City Bus, 9300, 9700, Interregio),
 Wrightbus

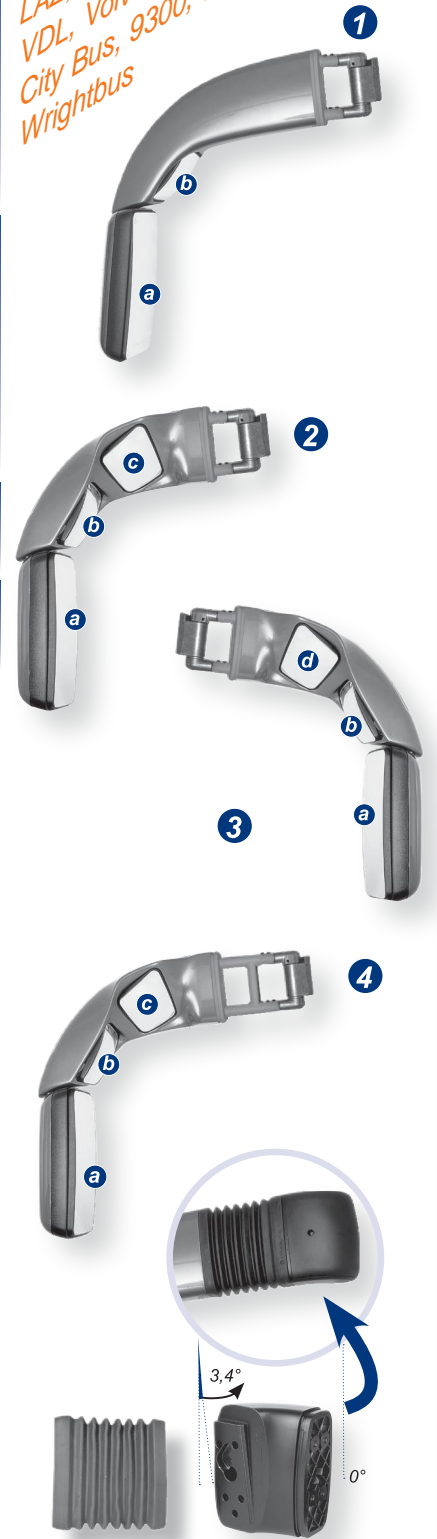

* für für pour 59.2710.406
 2 pieces necessary

UNIVERSAL COACHES

291	II (E1) 021203			INTEGR.
	IV (E1) 021207			

	Beschreibung description descrição descrizione benámenning popis ömrcauwe beireik opis		OE
--	--	--	-----------

CAETANOBUS Cobus 3000
 CONCORDE Charisma III
 HESS
 MAN Lion's City
 PLAXTON Panther
 PLAXTON Elite
 PLAXTON R9700
 RUNIRAN R9700
 TEMSA Safir
 TEMSA Safir
 TEMSA MD 9
 VISEON C-Serie
 Volvo 9700 / 9900
 VDL Futura

01/2012
 08/2012
 01/2011
 10/2012
 2011
 10/2010
 05/2011
 06/2011
 10/2011



1

Spiegel mit HS, WWS
mirror with HS, WWS



2

Spiegel mit HS und Bugspiegel
mirror with HS and front crossview mirror

1	59.2910.001.001		1196 x 696 x 239	284215 (Concorde) 5053-APA-06Y (TEMSA) 44.17604-0317 (Viseon) 2187 9369 (Volvo)
	59.2910.002.001		1196 x 696 x 239	284216 (Concorde) 5053-APA-04Y (TEMSA) 44.17604-0318 (Viseon) 2189 4545 (Volvo)
	59.2910.012.001		1196 x 696 x 239	
	59.2910.019.001		1196 x 696 x 239	203722 (Carthago)
	59.2910.020.001		1196 x 696 x 239	203723 (Carthago)
	59.2910.009.001		1196 x 969 x 239	AP140857C-1 (Plaxton)
	59.2910.010.001		1196 x 696 x 239	AP119170C-2 (Plaxton) MD301145Y (TEMSA)
	59.2910.005.001		1196 x 696 x 239	2202 6968 (Carrus)
	59.2910.006.001		1196 x 696 x 239	
	59.2910.015.001		1196 x 696 x 239	22360737 (Volvo)
59.2910.016.001		1196 x 696 x 239	22360738 (Volvo)	
2	59.2910.003.001		1196 x 696 x 239	AP119170C-100 (Plaxton) 44.17604-0321 (Viseon)
	59.2910.004.001		1196 x 696 x 239	HD301144Y (TEMSA) 44.17604-0322 (Viseon) 2187 9404 (Volvo)
	59.2910.017.001		1196 x 696 x 239	158388C (Plaxton)
	59.2910.018.001		1196 x 696 x 239	158396C (Plaxton)
59.2910.007.001		1196 x 696 x 239		
59.2910.008.001		1196 x 696 x 239	2202 6977 (Volvo)	
3	59.2910.013.001		1196 x 696 x 239	248268 (Concorde)
4	59.2910.014.001		1196 x 696 x 239	248269 (Concorde)



3

Spiegel mit HS, WWS und ZS (links)
mirror with HS, WWS and ZS (left)



4

Spiegel mit HS, WWS und NBS (rechts)
mirror with HS, WWS and NBS (right)

UNIVERSAL COACHES

291	II (E1) 021203			INTEGR.
	IV (E1) 021207			

		Beschreibung description description description description description opis opis opis opis	mm	OE
61.2910.001.001			262 x 150	
61.2910.002.001			262 x 150	22117455 (Volvo)
61.2910.003.001			312 x 150	5053-APA-05Y (Temsas)
61.2910.004.001			312 x 150	5053-APA-03Y (Temsas)
61.2910.007.001		(with LED)	312 x 150	22117457 (Volvo)
61.2910.008.001		(with LED)	312 x 150	21885965 (Volvo)
61.2910.005.001			412 x 150	HD 301152 (Temsas)
61.2910.006.001			412 x 150	HD 301151 (Temsas)
61.2910.021.001			412 x 150	284217 (Concorde)
61.2910.022.001			412 x 150	284218 (Concorde)
09.2910.007.000			1050 x 6 ø	
09.2910.004.099			2750 x 6 ø	201931 (Carthago)
09.2910.005.099			3550 x 6 ø	2218519 (Bürstner) 200070749 (Eura Mobil)
09.2910.002.099			6050 x 6 ø	2218516 (Bürstner) 284221 (Concorde) 200070751 (Eura Mobil) 44.15240-0300 (Viseon) 2203 8103 (Volvo)
09.2910.003.099		(for LED or)	6050 x 6 ø	22212554 (Volvo)
09.2770.001.000			6050 x 6 ø	
08.3200.233H			42 x 42 x 54	20925244 (Volvo)

CAETANOBUS Cobus 3000 01/2012
 CONCORDE Charisma III 08/2012
 HESS
 MAN Lion's City
 PLAXTON Panther
 PLAXTON Elite
 RUNIRAN R9700
 TEMSA Safari
 TEMSA Safir
 TEMSA MD 9
 VISEON C-Serie
 Volvo 9700 / 9900
 VDL Futura

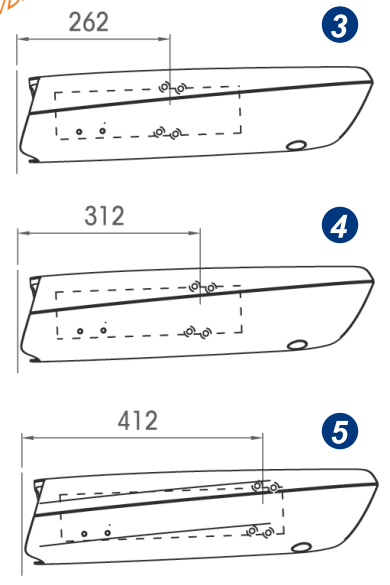

15.2780.840			307 x 177 x 22	81.63733-0113 (MAN) P119170C-8 (Plaxton) 5053-APA-04-01Y (TEMSA) 30017846 (VDL) 48.17600-0026 (Viseon)
15.2780.841F			307 x 177 x 22	201932 (Carthago)
19.2910.001.099			184 x 154 x 31	P119170C-7 (Plaxton) 5053-APA-04-03Y (TEMSA)
19.2910.002.099			184 x 172 x 39	HD301144-02Y (TEMSA)
08.3950.001.099	Control Unit for		40 x 30 x 30	22038110 (Volvo)
08.2910.001.002	LED			22488075 (Volvo)
61.5590.001.099		for 3 and 4	256 x 165 x 82	
11.2910.001.000		für pour back	597 x 105 x 66	
11.2910.002.000		für pour back	617 x 112 x 105	
11.2910.003.000		für pour front	651 x 112 x 146	
11.2910.004.000		für pour front	509 x 112 x 123	
11.2910.006.000		für pour back	597 x 105 x 66	
11.2910.007.000		für pour back	617 x 112 x 105	
11.2910.008.000		für pour front	651 x 112 x 146	
11.2910.009.000		für pour front	509 x 112 x 123	
11.2910.011.002		für pour	514 x 225 x 121	
11.2910.012.002		für pour	514 x 225 x 121	

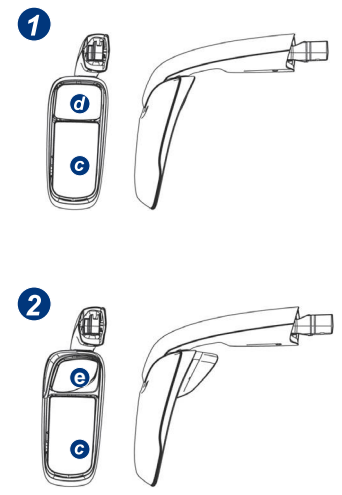

UNIVERSAL

Heizkabel mit Steckanschluss
Heating cable with plug



Steuerkabel
control cable

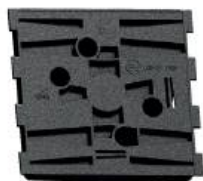

UNIVERSAL ELECTRONICS

MEKRA LANG Group		Beschreibung description description description description benämning popis ovracavke özelliik leirats opis	mm	OE
09.2070.101H			2070 x 9ø	
09.2000.301H			2000 x 9ø	

MEKRA LANG Group		Beschreibung description description description description benämning popis ovracavke özelliik leirats opis	mm	OE
09.3200.320H			2000 x 6ø	
09.3300.421			2000 x 6ø	









MEKRA LANG Group		Beschreibung description description description description benämning popis ovracavke özelliik leirats opis	mm	OE
08.3200.233H			42 x 42 x 54	

MEKRA LANG Group		Beschreibung description description description description benämning popis ovracavke özelliik leirats opis	mm	OE
09.3200.420H			42 x 42 x 54 [2000]	
08.3200.233H			42 x 42 x 54	
09.3200.220			1000	
09.3200.320H			2000 x 6ø	
09.3400.420			42 x 42 x 54 [2000]	
08.3200.233H			42 x 42 x 54	
09.3200.220			1000	
09.3200.320H			2000	
09.3300.421			2000	

MEKRA LANG Group		Beschreibung description description description description benämning popis ovracavke özelliik leirats opis	mm	OE
08.5752.024.099			130 x 94 x 53	
08.1024.124.099			130 x 120 x 45	
08.5752.024.099			130 x 94 x 53	
08.1024.124.099			130 x 120 x 45	

UNIVERSAL ACCESSORIES



248/2 A

		Beschreibung description description description description benámening popis описание özellik leirás opis	 mm	
20.2480.210H			108 x 50 x 15	5571298 (Bomag) D067504 (Bredamenarini) 218 142 (Fritzmeier) 84433427 (Case New Holland) 7621216 (Liebherr) 17294377-6 (Marcopolo) 671 811 0111 (Mercedes) P105367C-15 (Plaxton) 144 8217 (Scania) 7035 2646 (Volvo) 8706 2719 00055 (Volvo)
20.2480.211H			108 x 50 x 15 [2500]	145 1227 (Scania) 1990-685-650 (Solaris) 2085 4088 (Volvo) 8350 003620 (Volvo)
20.2480.223			108 x 50 x 15 [150]	81.63731-6478 (MAN) 17294378-2 (Marcopolo) 2051 5454 (Volvo) 8706 2719 00040 (Volvo)
20.2480.213			108 x 50 x 15 [800]	356 810 06 11 (Mercedes) AA-01980 / AA-01981 (Plaxton)
20.2480.216H			108 x 50 x 15 [2000]	284240 (Concorde) VI-10-01-010 (Eura Mobil) R21640 (Lahden) 83.63731-6507 (MAN) 53-750610-208091 (Merkavim) 145 1226 (Scania) 1970-018-000 (Solaris) P759001645 (VDL) 7033 1124 / 8350 046971 (Volvo) 284242 (Concorde) 425 45985 (Iveco) 77037873 (Komatsu)
20.2480.217H			108 x 50 x 15 [5000]	R21645 (Lahden) 81.63731-6470 (MAN) 53-7072 13-480217 (Merkavim) P107424C-10 (Plaxton) P759001646 (VDL) 7033 1123 / 7034 8002 (Volvo) 8350 046432 / 8706 2719 00018 (Volvo)

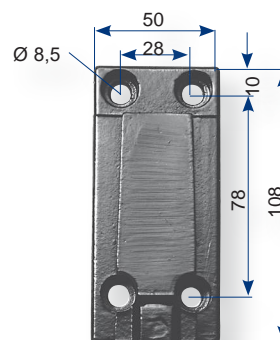
Aufsteckkeile
Mounting wedges



271 A

		Beschreibung description description description description benámening popis описание özellik leirás opis	 mm	
20.2710.620			124 x 59 x 21 [500]	200083489 (Eura Mobil) 50.00.021.163 (Irisbus) 17042340N0000 (Krauss-Maffei) 53-7072 13-710620 (Merkavim) 7033 1941 (Volvo)

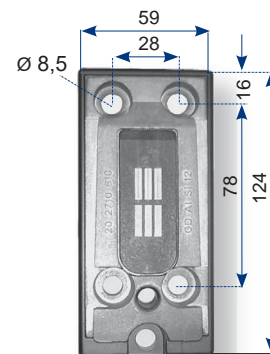

UNIVERSAL AGRICULTURE

1016



Ø 22 mm

Beschreibung
description
descrição
descriptione
description
benämning
pops
omicauwe
üzeylik
opis



OE

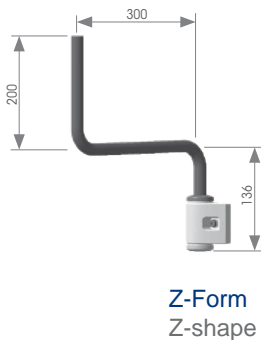
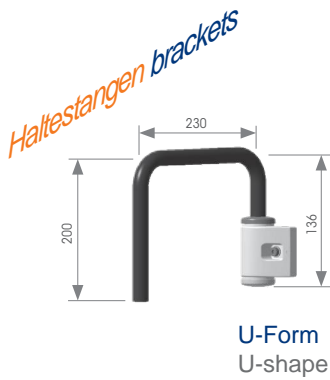

U	58.1016.001.099	1	200 x 230 x 136
	58.1016.002.099	1	200 x 230 x 136
	58.1016.003.099	2	200 x 230 x 136
	58.1016.004.099	2	200 x 230 x 136
Z	58.1016.005.099	1	336 x 300
	58.1016.006.099	1	336 x 300
	20.1016.004.000	Sechskant hex attachment for 1	

Manuell verstellbar in 30°-Stufen

Manually adjustable in steps of 30°

Montage von Innenseite Fahrzeug verschraubt (Variante 2) oder von außen mittels Sechskant verschweißt (Variante 1) möglich

Mounting base bolted through hex attachment (Version 1) or directly bolted from vehicle side (Version 2)

Sowohl hängend als auch stehend montierbar (Darstellung: stehend)

Tube can be turned upside down hanging and standing (Shown: standing)

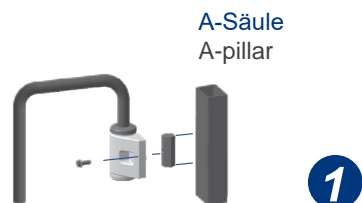
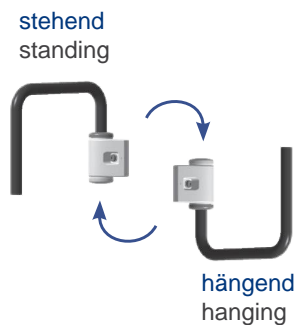

Montage von Außenseite Fahrzeug verschweißt
Mounting base bolted through hex attachment

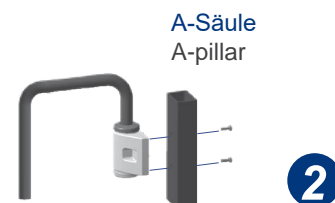

Montage von Innenseite Fahrzeug verschraubt
Mounting directly bolted from vehicle side

UNIVERSAL BUSES

270 A		st		Ø 28 mm	
MEKRA LANG Group		mm		OE	
Beschreibung description description description benamining papas описание leirats opis					
58.2704.051H		90°	270 x 464 x 28 ø	0783032 (Dethleffs) 1905-509-025 (Solaris)	1
58.2704.048		90°	216 x 514 x 28 ø	HEO 627 810 M1 47 (EvoBus) 3600100512654 (Evobus) 1905-508-000 (Solaris) 0000-217-083 (Solaris) 7032 8298 (Volvo) 7033 1060 (Volvo) 2053 5857 (Volvo)	2
58.2704.044		90°	216 x 514 x 28 ø		
58.2704.088		120°	216 x 514 x 28 ø	50.06.232.165 (Irisbus)	
58.2704.070		6°	732 x 327 x 28 ø	1905-509-000 (Solaris) 7032 8294 (Volvo)	3
58.2704.086		6°	732 x 327 x 28 ø	1905 500 010 (Solaris) 2056 4284 (Volvo)	
58.2704.093		6°	732 x 327 x 28 ø	1905-506-010 (Solaris)	
58.2705.003		17°	668 x 350 x 28 ø	7035 2000 (Volvo)	4
58.2705.001H		17°	668 x 350 x 28 ø	7030 9620 (Volvo) 8706 2719 00056 (Volvo) VG10037.000 (Volvo)	
61.2708.842H				150 5203 (Scania)	
61.2703.110		128°	156 x 129 x 36	000 810 04 12 (Mercedes)	
61.2703.120		56°	156 x 129 x 36	000 810 05 12 (Mercedes)	

Haltestangen brackets

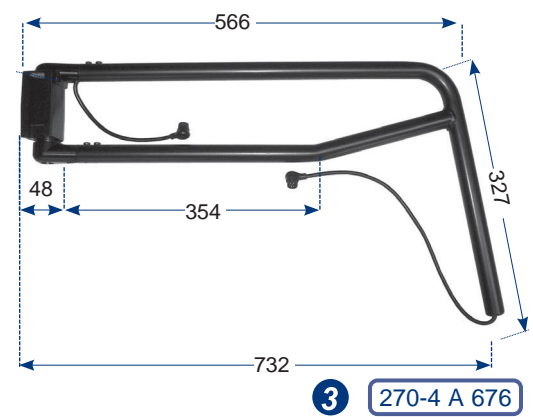
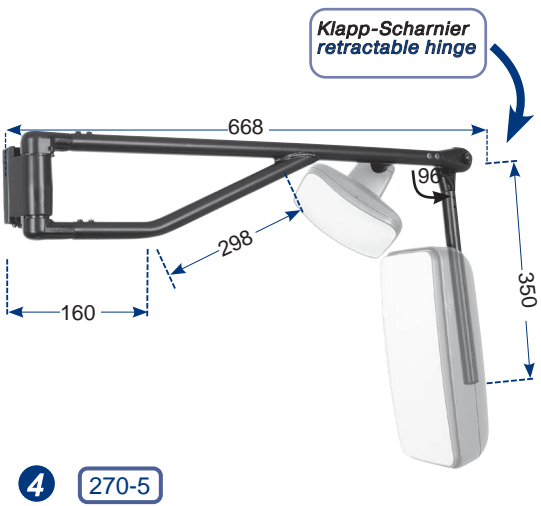
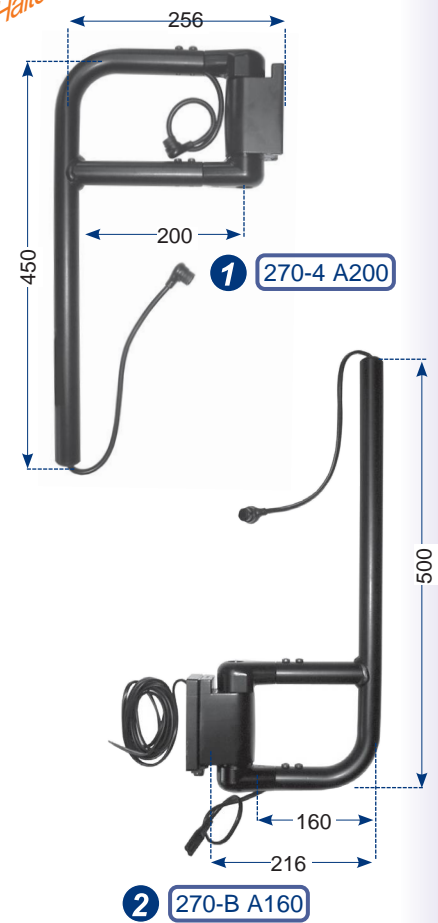

4 270-5

Klappstange
hinged tube

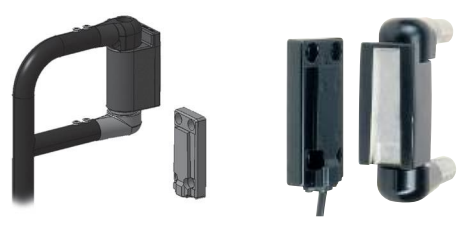

3 270-4 A 676

UNIVERSAL

ALLGEMEINE GESCHÄFTSBEDINGUNGEN (AGB)

I. Allgemeine Bedingungen

Den Vertragsbeziehungen zwischen uns, MEKRA Lang GmbH & Co. KG („MEKRA Lang“), und unseren Bestellern, die Unternehmer im Sinne des § 14 BGB sind, liegen ausschließlich die nachfolgenden AGB zugrunde. Abweichende Geschäftsbedingungen des Bestellers werden, selbst bei Kenntnis, nicht Vertragsbestandteil. Unsere Angebote sind stets freibleibend. Unsere AGB gelten mit der Auftragserteilung, spätestens mit der Annahme der Ware als anerkannt. Diese AGB gelten bei ständigen Geschäftsbeziehungen auch für alle künftigen Geschäfte. Sollten einzelne Bestimmungen ganz oder teilweise unwirksam sein oder werden, so wird hierdurch die Gültigkeit der übrigen Bestimmungen nicht berührt. In diesem Fall werden MEKRA Lang und der Besteller eine Regelung vereinbaren, deren wirtschaftlicher Erfolg dem der unwirksamen Regelung möglichst nahe kommt. Bis dahin gilt die Gesetzeslage.

II. Vertragsschluss und Preise

- Mit der Bestellung einer Ware erklärt der Besteller verbindlich, die bestellte Ware erwerben zu wollen. Er ist an diese Erklärung zwei Wochen gebunden. Wir sind berechtigt, das in der Bestellung liegende Vertragsangebot innerhalb von zwei Wochen nach Eingang bei uns anzunehmen. Die Annahme kann schriftlich, elektronisch oder durch Auslieferung der Ware an den Besteller erklärt werden.
- Die Verpflichtungen im elektronischen Geschäftsverkehr gem. § 312e Abs. 1 Satz 1 Nr. 1 bis 3 und Satz 2 BGB werden ausgeschlossen.
- Der Vertragsschluss erfolgt unter dem Vorbehalt der richtigen und rechtzeitigen Selbstbelieferung durch unsere Zulieferer. Dies gilt nur für den Fall, dass die Nichtbelieferung nicht von uns zu vertreten ist, insbesondere bei Abschluss eines kongruenten Deckungsgeschäftes mit unseren Zulieferern. Der Besteller wird über die Nichtverfügbarkeit der Leistung unverzüglich informiert und die Gegenleistung, soweit bereits geleistet, unverzüglich zurückerstattet.
- Alle vertraglichen Zahlungsverpflichtungen sind ausschließlich in EURO zu erfüllen.
- Die Preise verstehen sich netto ab Werk bzw. Auslieferungslager. Fracht-, Verpackungs-, Einfuhrkosten, Zoll und sonstige Nebenabgaben gehen zu Lasten des Bestellers.

III. Lieferzeit und Lieferverpflichtung

- Für Umfang, Art und Zeitpunkt der Lieferung ist unsere schriftliche oder elektronische Auftragsbestätigung maßgebend. Teil-Lieferungen sind zulässig.
- Eine Verpflichtung zur Einhaltung als verbindlich bezeichneter Lieferfristen wird nur unter der Voraussetzung eines ungestörten Betriebs- und Vertriebsablaufs übernommen; insbesondere in Fällen höherer Gewalt und sonstiger störender Ereignisse bei uns, bei unseren Lieferanten oder bei den Transportunternehmern, beispielsweise Betriebs- oder Verkehrsstörungen, Feuer, Überschwemmungen, Arbeitskräfte-, Energie- oder Verkehrsmangel, Streik, Aussperrung, behördliche Maßnahmen sowie technische oder technologische Umstände, welche die Auftragsausführung wesentlich erschweren, entbinden uns von der Pflicht zur rechtzeitigen Lieferung oder geben uns das Recht, unsere Lieferung ohne Nachlieferpflicht einzustellen.
- Sofern nichts Abweichendes vereinbart ist, sind wir berechtigt, bereits vor einem genannten Liefertermin zu leisten. Ebenso gilt, sofern nichts Abweichendes vereinbart ist, eine bis maximal zwei Wochen über einem genannten Liefertermin liegende Leistung unsererseits nicht als verspätet.
- Lieferfristen gelten als eingehalten, wenn bis zu ihrem Ablauf die Ware das Werk oder Auslieferungslager verlassen hat oder dem Besteller die Anzeige unserer Versandbereitschaft zugegangen ist. Nachträgliche Änderungen des Vertrages verlängern die Lieferfristen angemessen.
- Bei Verträgen, deren Erfüllung aus mehreren Lieferungen besteht, ist Nichterfüllung, oder mangelhafte oder verspätete Erfüllung einer Lieferung ohne Einfluss auf andere Lieferungen aus dem Vertrag.
- Zahlungsverzug, die Abgabe einer eidesstattlichen Offenbarungsversicherung gemäß § 807 ZPO, eintretende Zahlungsschwierigkeiten oder das Bekanntwerden einer wesentlichen Verschlechterung der Vermögensverhältnisse des Bestellers berechtigen uns nach unserer Wahl, für noch offenstehende Lieferungen Vorauszahlung zu verlangen oder Lieferungen sofort einzustellen und die Erfüllung laufender Verträge zu verweigern. Gleichzeitig sind wir berechtigt, noch nicht fällige Forderungen gegen den Besteller sofort fällig zu stellen.

IV. Versand, Gefahrenübergang

- Verpackung, Versandweg und Transportmittel sind unserer Wahl überlassen, es sei denn, es ist zwischen den Parteien etwas anderes vereinbart.
- Die Gefahr des zufälligen Untergangs und der zufälligen Verschlechterung der Ware geht mit der Übergabe, beim Versandkauf mit der Auslieferung der Sache an den Spediteur, den Frachtführer oder der sonst zur Ausführung der Versendung bestimmten Person oder Anstalt, auf den Besteller über. Der Übergabe steht es gleich, wenn der Besteller im Verzug der Annahme ist.
- Ware aus Abrufaufträgen ist, wenn nicht anders vereinbart, innerhalb von 3 Monaten nach Erteilung der Auftragsbestätigung abzunehmen.
- Versicherung gegen Bruch- und Transportrisiken werden nur auf besonderen Wunsch gegen Berechnung der Kosten übernommen.
- Zoll und sonstige Spesen, auch die Unkosten für Bezahlung der zur Einfuhr in das Bestimmungsland notwendigen Papiere, gehen zu Lasten des Käufers.

V. Zahlung, Zahlungsbedingungen

- Rechnungen sind zahlbar:
 - innerhalb von 14 Tagen ab Rechnungsdatum mit 2 % Skonto vom Rechnungswert.
 - innerhalb von 30 Tagen ab Rechnungsdatum ohne Skonto vom Rechnungswert.
- Kassa - Skonto wird nur gewährt, wenn sämtliche Zahlungsverpflichtungen aus früheren Lieferungen erfüllt sind und der Rechnungsbetrag pünktlich bis zu den vorgeannten Fälligkeitstagen bei uns in bar vorliegt oder unserem Konto gutgeschrieben ist. Wechselheringabe kann also nicht zur Gewährung von Kassa -Skonto führen. Bei bargeldloser Zahlung, insbesondere auch bei Scheckheringabe, kommt es auf den Zeitpunkt

der Gutschrift an. Bei Zahlung oder Gutschrift unter Vorbehalt, unter einer Bedingung oder sonstigen Einschränkungen kann Skonto nicht gewährt werden. Das Risiko des Zahlungsweges trägt der Besteller. Rechnungen für Werkzeuge sind ohne Skontoabzug sofort zahlbar.

- Die Annahme von Wechseln und Schecks erfolgt nur erfüllungshalber. Entsprechende Gutschriften erfolgen nur unter Vorbehalt des Einganges des vollen Betrages. Die Hereinnahme von fremden oder eigenen Akzepten behalten wir uns vor. Kosten und Diskontospesen gehen zu Lasten des Bestellers. Eine Gewähr für Vorlage und Protest übernehmen wir nicht. Protesterhebung eigener Wechsel des Bestellers oder nicht sofortige Abdeckung protestierter Fremdwechsel ermächtigen uns, sämtliche noch laufende Wechsel zurückzugeben. Gleichzeitig sind wir berechtigt, nicht fällige Forderungen gegen den Besteller sofort fällig zu stellen. Vordatierte Schecks werden nicht angenommen.
- Bei Überschreitung des Zahlungstermins werden Verzugszinsen in Höhe von 9 %-Punkten über dem jeweiligen Basiszinssatz gem. § 247 BGB sowie eine Verzugschadenspauschale in Höhe von 40,00 Euro gem. § 288 Abs. 5 BGB fällig. Die Geltendmachung eines weiteren Verzugschadens oder anderer Rechte bleibt vorbehalten.
- Voraus- und Abschlagszahlungen werden nicht verzinst.
- Zur Aufrechnung oder Einbehaltung von Zahlungen ist der Besteller nur berechtigt, wenn seine Gegenforderung unbestritten oder rechtskräftig festgestellt ist. Der Besteller kann ein Zurückbehaltungsrecht nur ausüben, wenn sein Gegenanspruch auf demselben Vertragsverhältnis beruht.
- Beim Ausgleich von Rechnungen sind vom Besteller seine Kundennummer und die Rechnungsnummer anzugeben. Verzögerungen oder Fehlbuchungen, die infolge Nichteinhaltung dieser Verpflichtungen eintreten, gehen zu Lasten des Bestellers.

VI. Eigentumsvorbehalt, Factoring

- Die gelieferte Ware bleibt bis zur Bezahlung aller bestehenden Forderungen aus der Geschäftsverbindung mit dem Besteller unser Eigentum. Der Besteller ist im Rahmen des ordnungsgemäßen Geschäftsganges zur Weiterveräußerung der Vorbehaltsware berechtigt; eine Verpfändung oder Sicherungsübereignung ist ihm jedoch nicht gestattet. Bei einem Weiterverkauf von Vorbehaltsware auf Kredit ist er verpflichtet unsere Rechte zu sichern.
- Die Forderungen des Bestellers aus der Weiterveräußerung der Vorbehaltsware tritt dieser schon jetzt in Höhe des Rechnungsbetrages an uns ab; Wir nehmen diese Abtretung an. Ungeachtet der Abtretung ist der Besteller zur Einziehung solange berechtigt, als er seinen Verpflichtungen uns gegenüber aus dem zugrundeliegenden Vertragsverhältnis nachkommt und nicht in Vermögensverfall gerät. Andernfalls hat er auf unser Verlangen die zur Einziehung erforderlichen Angaben über die abgetretene Forderung zu machen und seinen Schuldnern diese Abtretung anzuzeigen. Für diesen Fall behalten wir uns vor, die Forderung selbst einzuziehen.
- Eine etwaige Be- oder Verarbeitung der Vorbehaltsware durch den Besteller erfolgt stets im Namen und im Auftrag für uns, ohne dass uns jedoch Verbindlichkeiten hieraus erwachsen dürfen. Bei der Verarbeitung der Vorbehaltsware mit anderen, uns nicht gehörenden Waren, steht uns der dabei entstandene Miteigentumsanteil an der neuen Sache im Verhältnis des Wertes der Vorbehaltsware zu der übrigen verarbeiteten Ware zu. Soweit hier und auch nachfolgend auf den Wert der Vorbehaltsware abgestellt ist, ergibt sich diese aus unserem Fakturawert.
- Erwirbt der Besteller das Alleineigentum an der neuen Sache gemäß § 947 Abs. 2 BGB, so besteht Einigkeit darüber, dass er uns im Verhältnis des Wertes der verarbeiteten bzw. verbundenen oder vermischten Vorbehaltsware Miteigentum an der neuen Sache einräumt und diese unentgeltlich für uns bewahrt.
- Wird die Vorbehaltsware zusammen mit anderen Waren, und zwar gleichgültig, ob ohne oder nach Verarbeitung, Verbindung oder Vermischung weiter veräußert, so gilt die oben vereinbarte Vorausabtretung nur in Höhe des Wertes der Vorbehaltsware, die zusammen mit den anderen Waren weiterveräußert wird. Wir verpflichten uns, die uns nach den vorstehenden Bestimmungen zustehenden Sicherungen auf Verlangen insoweit freizugeben, als der Wert die zu sichernden Forderungen mit 20 % übersteigt.
- Über Zwangsvollstreckungsmaßnahmen Dritter in die Vorbehaltsware oder die im Voraus abgetretenen Forderungen hat uns der Besteller unverzüglich unter Übergabe der für eine Intervention notwendigen Unterlagen zu unterrichten. Daraus bei uns entstehende Interventionskosten sind vom Besteller zu tragen.
- Der Besteller hat die Vorbehaltsware ausreichend gegen Feuer und Einbruchsdiebstahl zu versichern und uns dies auf Verlangen nachzuweisen.

VII. Mängelansprüche

- Die Verjährungsfrist für Mängelansprüche beträgt 24 Monate ab Ablieferung der Ware.
- Wir leisten für Mängel der Ware zunächst nach unserer Wahl Gewähr durch Nachbesserung oder Ersatzlieferung. Bei Fehlschlägen von Nachbesserung oder Ersatzlieferung kann der Besteller Rückgängigmachung des Vertrages oder Herabsetzung der Vergütung verlangen. Bei einer nur geringfügigen Vertragswidrigkeit, insbesondere bei nur geringfügigen Mängeln, steht dem Besteller jedoch kein Rücktrittsrecht zu.
- Der Besteller hat offensichtliche Mängel unverzüglich, spätestens innerhalb von 7 Tagen nach Eingang der Ware unter sofortiger Einstellung etwaiger Bearbeitung schriftlich anzuzeigen. Andernfalls ist die Geltendmachung von Mängelansprüchen ausgeschlossen. Zur Fristwahrung genügt die rechtzeitige Absendung. Den Besteller trifft die volle Beweislast für sämtliche Anspruchsveroraussetzungen, insbesondere für den Mangel selbst, für den Zeitpunkt der Feststellung des Mangels und für die Rechtzeitigkeit der Mängelrüge.
- Mängel, die auch bei sorgfältiger Prüfung innerhalb dieser Frist nicht entdeckt werden können, sind unverzüglich nach Entdeckung schriftlich zu rügen. Wählt der Besteller wegen eines Rechts- oder Sachmangels nach gescheiterter Nacherfüllung den Rücktritt vom Vertrag, steht ihm daneben kein Schadensersatzanspruch wegen des Mangels zu.
- Wählt der Besteller nach gescheiterter Nacherfüllung Schadensersatz, verbleibt die Ware beim Besteller, wenn ihm dies zumutbar ist. Der

Schadensersatz beschränkt sich auf die Differenz zwischen Kaufpreis und Wert der mangelhaften Sache. Dies gilt nicht, wenn wir die Vertragsverletzung arglistig verursacht haben.

- Ware, für die wir Ersatz geleistet haben, geht in unser Eigentum über und ist an uns zurückzusenden gegen Kostenerstattung.
- Ansprüche bestehen nicht für solche Schäden, die dadurch entstanden sind, dass der Besteller schuldhaft
 - den Kaufgegenstand unsachgemäß behandelt oder überanspricht hat oder
 - den Kaufgegenstand in einer nicht vereinbarten Weise verändert hat oder
 - die Vorschriften der Montage- oder Betriebsanleitung nicht befolgt hat oder
 - die Rüge- und Zustellungspflicht gemäß vorstehender Ziffer 3 und 4 verletzt hat oder
 - den Kaufgegenstand nach Mangelfeststellung weiterbenutzt hat.
 Natürlicher Verschleiß ist von der Gewährleistung ausgenommen.

VIII. Haftung

- Bei leicht fahrlässigen Pflichtverletzungen beschränkt sich unsere Haftung auf den nach der Art der Ware vorhersehbaren, vertragstypischen, unmittelbaren Durchschnittsschaden. Dies gilt auch bei leicht fahrlässigen Pflichtverletzungen unserer gesetzlichen Vertreter oder Erfüllungsgehilfen. Bei leicht fahrlässiger Verletzung unwesentlicher Vertragspflichten haften wir nicht.
- Die Haftung aufgrund übernommener Garantien sowie aufgrund Produkthaftung bleibt unberührt, ebenso bei uns zurechenbaren Körper- oder Gesundheitsschäden oder bei Verlust des Lebens des Bestellers.
- Schadensersatzansprüche des Bestellers wegen eines Mangels verjähren nach einem Jahr ab Anlieferung der Ware. Dies gilt nicht, wenn uns Vorsatz oder grobes Verschulden vorwerfbar ist, sowie im Falle von uns zurechenbaren Körper- und Gesundheitsschäden oder bei Verlust des Lebens des Bestellers.

IX. Rücknahme

Ordnungsgemäß bestellte und gelieferte Ware wird grundsätzlich nicht zurückgenommen. Ausnahmen bilden Rücknahmen, die mit uns vereinbart wurden. Zusätzlich müssen folgende Voraussetzungen erfüllt werden:

- Die Produkte müssen von uns oder von einem unserer Werkslager direkt bezogen worden sein.
- Einwandfreier und unveränderter Zustand der Ware.
- Rückgängigkeit ist die Rücknahme durch uns nur dann möglich, wenn die zur Rückgabe vorgesehenen Teile noch im Lieferprogramm sind.
- Rückversand muss „frei Haus“ an unser Werk Ergersheim oder an das zuständige Werkslager unter Angabe von Liefererscheindatum und -nummer erfolgen. Wertabschlag bei Rücknahme:
 - im 1. Jahr nach Liefertag *J. 10 %* vom Lieferpreis
 - im 2. Jahr nach Liefertag *J. 25 %* vom Lieferpreis
 - zwischen 3. und 5. Jahr nach Liefertag *J. 50 %* vom Lieferpreis
 - Ware älter als 5 Jahre keine Rücknahme möglich.

Nach Erhalt der Teile erfolgt die technische Überprüfung und Erstellung der Gutschrift unter Berücksichtigung eines etwaigen Wertabschlages. Frachtkosten, sofern sie für den ursprünglichen Versand für uns entstanden sind, vermindern den Restwert.

X. Schutzrechte

- Bei kundenspezifischen Sonderanfertigungen haftet der Besteller uns für die Freiheit von Schutzrechten Dritter der in Auftrag gegebenen Lieferungen, stellt uns von etwaigen Ansprüchen Dritter frei und hat uns etwaigen aus einer Verletzung dieser Pflicht resultierenden Schaden zu ersetzen.
- Unsere Entwürfe und Konstruktionsvorschläge sind vertraulich zu behandeln und dürfen nicht an Dritte weitergegeben werden.
- Sämtliche Zeichnungen, Konstruktionspläne und Muster, die dem Besteller zugegangen sind, bleiben unser geistiges Eigentum.

XI. Erfüllungsort, Gerichtsstand, sonstige Vereinbarungen

- Als Beschaffenheit der Ware gilt grundsätzlich nur unsere Produktbeschreibung als vereinbart. Öffentliche Äußerungen, Anpreisungen oder Werbung durch uns stellen daneben keine vertragsgemäße Beschaffenheitsangabe der Ware dar. Proben und Muster gelten als annähernde Anschauungsstücke für Qualität, Abmessungen und Farbe. Rechtsansprüche können hieraus nicht abgeleitet werden. Technische Änderungen sowie Änderungen in Form, Farbe und/oder Gewicht bleiben uns im Rahmen des Zumutbaren vorbehalten.
- Erhält der Besteller eine mangelhafte Montageanleitung, sind wir lediglich zur Lieferung einer mangelfreien Montageanleitung verpflichtet und dies auch nur dann, wenn der Mangel der Montageanleitung der ordnungsgemäßen Montage entgegensteht.
- Garantien im Rechtssinne erhält der Besteller durch uns nicht; Herstellergarantien bleiben hiervon unberührt.
- Erfüllungsort für unsere Lieferungen ist bei Lieferung ab Werk das Lieferwerk, bei Lieferung ab Lager das Lager. Erfüllungsort für alle Zahlungen ist Ergersheim / Bayern, Deutschland.
- Ausschließlicher Gerichtsstand für alle Streitigkeiten aus diesem Vertrag ist Fürth / Bayern, Deutschland. Dies gilt auch für evtl. Scheck- und Wechselklagen.
- Es gilt das Recht der Bundesrepublik Deutschland. Die Bestimmungen des UN-Kaufrechts finden keine Anwendung. Es ist allein der Text der deutschsprachigen Fassung dieser Allgemeinen Geschäftsbedingungen maßgeblich.
- Ergänzend gelten die mit den jeweiligen Preislisten bekannt gegebenen Sonderbedingungen unserer Produkte.
- Der Besteller ist selbst dafür verantwortlich, die Eignung von Waren für den beabsichtigten Verwendungszweck zu prüfen.
- Hinweis gemäß Bundesdatenschutzgesetz: Die zur Auftragsabwicklung erforderlichen Bestellerdaten werden gespeichert.

Stand 06/2017

GENERAL TERMS AND CONDITIONS OF SALE AND DELIVERY

I. General Provisions

1. The provisions of the contract between MEKRA Lang GmbH & Co. KG ("MEKRA Lang") and our orderers who are contractors as defined in para. 14 BGB are solely governed by these General Terms and Conditions. Our offers are exclusively meant for entrepreneurs as defined by Article 4 BGB (German Civil Code). Deviating business terms of the customer, even if they are known to us, shall not become a part of the contract. Our offers are always subject to change without notice. Our General Terms and Conditions of Sale and Delivery are considered accepted upon placement of order, at the latest upon receipt of goods. In the case of repeated business relations these General Terms and Conditions of Sale and Delivery also apply for all future transactions. Should individual provisions be or become completely or partially ineffective, then the validity of the other provisions shall thereby not be affected. MEKRA Lang and the customer shall agree upon a regulation the economic success of which shall be as close as possible to the ineffective one. Until such agreement the laws, administrative practice and judicature effective at the time of execution are to be applied.

II. Conclusion of Contract and Prices

1. By ordering merchandise the customer bindingly declares that he wants to buy the merchandise ordered. He shall be bound to this statement for two weeks. We are entitled to accept the offer of a contract underlying the order within two weeks upon receipt of the latter by us. The acceptance may be declared in writing, electronically, or by delivery of the goods to the customer.

2. The obligations in electronic commerce according to Section 312e, par. 1 sentence 1, Nos. 1 to 3, and sentence 2 of BGB (German Civil Code) are excluded.

3. The conclusion of the contract takes place subject to the correct and timely delivery by our sub-suppliers to us. This applies only in case we are not responsible for the non-delivery, especially in case of the conclusion of a congruent hedging business transaction with our sub-suppliers. The customer shall be informed about the non-availability of the product without delay, and the equivalent, insofar as already paid, shall be reimbursed immediately.

4. All contractual financial obligations are to be fulfilled solely in EURO.

5. Prices are understood to be net as ex factory or supply depot. Freight, packaging and import costs, customs duties and other additional taxes are payable by the customer.

III. Period of Delivery and Supply Commitment

1. Our written or electronic order confirmation shall be decisive for extent, type, and date of the delivery. Partial shipments shall be permitted.

2. A liability in meeting delivery deadlines determined as binding shall only be accepted under the condition of undisturbed flow of operations and distribution. In particular in cases of acts of God and other disruptive events at our facilities or those of our sub-suppliers or transport contractors, for example operational or traffic disruptions, fire, flooding, labour-, energy-, or traffic shortages, strikes, lockouts, official measures as well as technical or technological situations that considerably aggravate the execution of the contract, release us from liability in punctual delivery or give us the right to stop delivery without obligation for subsequent delivery.

3. If not agreed otherwise, we have the right to deliver earlier than the delivery deadline. Unless otherwise agreed upon, delivery effected by us one up to a maximum of two weeks after the stipulated delivery date shall not be considered as delayed.

4. Delivery deadlines shall be considered met when the goods have left the works or dispatch depot or the customer has received notice by expiration of the deadline of our readiness to deliver. Subsequent alteration of contract shall be cause for a reasonable extension of delivery deadlines.

5. In the case of contracts whose performance consists of several deliveries, non-performance, defective or delayed performance of one delivery remains without influence upon the other deliveries of the contract.

6. Default of payments, handing in of a state meant in lieu of an oath of disclosure in accordance with § 807 ZPO (German Code of Civil Procedure), temporary shortage of liquid funds, or public knowledge of a considerable deterioration of the financial circumstances of the customer shall entitle us at our discretion to demand payment in advance for outstanding deliveries or to stop deliveries immediately and to deny performance of current contracts. At the same time we shall be entitled to make immediately due and payable those accounts receivable from the customer which are not due yet.

IV. Shipment, Passage of Risk

1. Unless otherwise agreed by the Parties, the choice of packaging, shipping routes and method of transportation is subject to our discretion.

2. The risk of accidental loss and accidental deterioration of the merchandise shall pass over to the customer upon handing it over, in case of a mail order purchase upon delivery of the matter to the forwarding agent, the carrier, or another person or institution determined to execute the shipment. If the customer is overdue in accepting, this shall be equal to a handing over of the merchandise.

3. Merchandise out of call orders shall be accepted within 3 months after issuance of the acknowledgement of order, unless otherwise agreed.

4. Insurance against breakage and transportation risks shall only be taken out upon special request and shall be billed.

5. Customs duties and other expenses, also the costs for payment of the necessary papers for import into the country of destination, shall be payable by the customer.

V. Payments, Terms of Payment

1. Invoices shall be payable:

a) within 14 days from date of invoice with 2 % cash discount of the accumulated invoice value;

b) within 30 days from date of invoice without cash discount of the accumulated invoice value.

2. Cash discount shall only be granted after all payment commitments out of earlier deliveries have been fulfilled and the invoice amount has been punctually paid to us in cash or has been credited to our account by the aforementioned due dates. The drawing of a bill of exchange can thus

not lead to the granting of a cash discount. In case of cashless payment, especially when a cheque is submitted, the date of the credit entry shall be decisive. A cash discount cannot be granted in the case of payment or credit entry under reserve, with limiting conditions or any other restrictions. The customer shall assume all risks of method of payment. Invoices for tools are subject to immediate payment without cash discount.

3. Bills of exchange and checks shall only be accepted on account of payment. Corresponding credit entries are made only under the limiting condition of correct receipt of the complete amount due. We reserve the right to take in external or own acceptances. Costs and discount expenses are payable by the customer. We assume no responsibility for submission and protest. Protest imposed against the customer's own bills of exchange or non-immediate repayment of protested external bills of exchange shall entitle us to return all bills in circulation. At the same time we shall be entitled to make immediately due and payable those accounts receivable from the customer which are not yet due. Antedated checks shall not be accepted.

4. Interest on defaulted payment of 9%-points over the discount rate of the German Central Bank referred to in § 247 BGB (German Civil Law) as well as a liquidated damages of 40.00 Euro shall be charged in the case of missed payment dates. The right of assertion of further damages caused by delayed performance and other claims shall remain reserved.

5. Advance and part payments are not subject to interest payments.

6. The customer shall only be entitled to offset or withhold payment if his counterclaim is undisputed or has been determined legally binding. The customer may execute a right of retention only if his counter claim is based on the same contractual relationship.

7. Customer and invoice numbers are to be given by the customer when invoices are balanced. Delays or incorrect booking resulting from failure to do so shall be payable by the customer.

VI. Retention of Ownership, Factoring

1. The delivered goods shall remain our property until payment of all claims has been received. The customer has the right to resell the proviso goods within the scope of proper and orderly course of business; however, a pledge or transfer by way of security is not permissible. The customer is required to ensure our rights in the case of resale of proviso goods on credit.

2. The accounts receivable by the customer based on the resale of the merchandise subject to reservation shall now already be transferred to us in the amount of the invoice. We hereby agree to accept this transfer. Regardless of the assignment, the customer shall retain the right to collect payment under the condition that he fulfils his responsibilities to us according to the underlying contractual relationship and does not fall into financial decline. Otherwise the customer must provide the information about the assignment necessary for collection upon our demand and notify his debtors of the respective assignment. In this case we reserve the right to collect the accounts receivable by ourselves.

3. A possible finishing or processing of the merchandise sold subject to reservation by the customer shall always take place on our behalf and by order of us, without any obligations resulting for us from this, however. In the case of processing of proviso goods with other goods not belonging to us, we are entitled to the co-owner portion of the resulting product corresponding to the value of the proviso goods in relation to the other processed goods. Insofar as here and in the following the value of the proviso goods is referred to, this value results from our invoice value.

4. Should the customer acquire sole ownership of the new product according to § 947 paragraph 2 BGB, it is agreed upon that the customer grants co-ownership in the proportion of the value of the processed, attached, or mixed proviso goods, and that he protects these free of charge.

5. In the case of resale of the proviso goods together with other goods, regardless of with or without processing, attachment or mixing, the assignment in advance agreed to above shall be valid only to the extent of the value of proviso goods that were resold together with the other goods. We shall be obligated to release on demand the securities entitled as provided above, if the value exceeds secured payments by 20 %.

6. The customer must immediately notify us and provide the material necessary for an intervention in the case of compulsory execution by third parties against the proviso goods or in case of claims assigned in advance. Any costs resulting from such intervention shall be payable by the customer.

7. The customer shall be obligated to adequately insure the merchandise sold subject to reservation against fire and burglary and has to prove such insurance to us on demand.

VII. Warranty

1. The period of limitation for any warranty claim shall be 24 months as from handover of the goods.

2. First of all, we shall remedy a defect or make a substitute delivery at our discretion. In case of failure to rectify defects or to substitute delivery, the customer can demand rescission of the contract or reduction of the payment. In case there is only a minor contract violation, especially if there are only minor defects, the customer shall not have the right of contract cancellation, however.

3. The customer must notify us in writing of any obvious flaws immediately, at the latest within 7 days after receipt of the goods, and must refrain from any eventual working of protested goods. Otherwise claims based on defects are excluded. The timely dispatch shall suffice for the observance of the warranty deadline. The full burden of proof for all claim prerequisites rests with the customer, especially for the defect itself, for the date of the establishment of the defect, and for the timeliness of the complaint about the defect.

4. Defects which could not be ascertained within this time span despite careful inspection are to be reported to us in writing immediately upon discovery. If the customer opts for a withdrawal from the contract because of a legal imperfection or a physical defect after a failed subsequent fulfilment, then he shall not be additionally entitled to a claim for compensation because of the defect.

5. If, after a failed subsequent fulfilment, the customer opts for a compensation of the damage, then the merchandise shall remain with the customer if this can reasonably be considered acceptable. The compensation is restricted to the difference between the purchase price and the value of the defective

product. This shall not apply if we caused the contract violation maliciously.

6. Merchandise for which we have effected compensation shall become our property and is to be returned to us against reimbursement of costs.

7. Claims cannot be made for damages that resulted from the customer's culpably

a) improper handling or overstressing the purchased item or

b) altering the purchased item in a manner not agreed upon or

c) not following the instructions of the mounting or operating manual or

d) not observing the complaint and delivery responsibility according to points 3 and 4 above or

e) further using the purchased item after ascertaining the defect.

Natural wear and tear is excepted from the warranty.

VIII. Liability

1. In case of simply negligent violations of obligations our liability shall be restricted to an average damage predictable for the type of merchandise, typical for such a contract, and immediate. This also applies in case of simply negligent violations of our legal representatives or agents. We shall not be held liable in case of a simply negligent violation of nonessential contractual obligations.

2. The liability by virtue of acceptance of a guarantee as well as due to product liability remains unaffected; the same applies in case of bodily harm or health impairment attributable to us or in the event of loss of life of the customer

3. Compensation claims of the customer because of a defect shall superannuate after one year from the delivery of the merchandise to the customer. This shall not apply if we can be charged with gross negligence as well as in case of bodily harm or health impairment attributable to us or in the event of loss of life of the customer.

IX. Returns

Properly ordered and delivered goods shall in principle not be taken back. Returns that have been agreed upon with us shall remain the exception, which additionally require the following pre-requisites to be met:

1. The products must have been acquired directly from us or from one of our works depots.

2. Flawless and unaltered condition of the goods.

3. In principle, return shall only be possible when the articles in question are still in our product range.

4. Return shipment must be „free domicile“ to our Ergersheim works or to the appropriate works depot with accompanying delivery note date and number. Value reduction for returns:

- in the first year after delivery date *J.* 10 % of the contract price
- in the second year after delivery date *J.* 25 % of the contract price
- between the 3rd & the 5th year after deliv. date *J.* 50 % of the contract price
- merchandise over five years old - no return possible

Technical inspection and completion of the credit slip shall be carried out under consideration of eventual value reduction upon receipt of the articles. Freight costs, insofar as any occurred to us for the original shipping, reduce the remaining value.

X. Industrial Property Rights

1. The customer is held liable to us for the exemption from industrial protection rights of third parties on articles ordered, indemnifies us against any possible claims of third parties and has to reimburse any damage to us possibly resulting from a violation of this obligation.

2. Our designs and design proposals are to be kept confidential and may not be passed on to third parties.

3. All drawings, construction plans, and samples which the customer has received, shall remain our intellectual property.

XI. Place of Fulfillment and Jurisdiction, Other Agreements

1. On principle, the product description of the manufacturer is understood to be decisive for the characteristics of the goods. Public statements, sales talks, or advertisements made apart from this do not represent a contractual description of the characteristics of the goods. Samples and specimens serve as approximate illustrative articles in terms of quality, measurements and colour. Legal claims cannot be inferred from this. Technical changes as well as alterations in shape, colour, and/or weight are reserved within reasonable scope.

2. If the customer receives a faulty assembly instruction, we shall only be obligated to furnish a faultless assembly instruction, and this only if the fault of the assembly instruction is in contradiction with a proper assembly.

3. The customer does not receive warranties in the legal sense of the word from us; warranties of the manufacturers, however, shall remain unaffected by this.

4. Place of fulfillment for our deliveries ex works shall be the delivery works, for delivery ex storage the warehouse. Place of fulfillment for all payments shall be Ergersheim / Bavaria, Germany.

5. The exclusive place of jurisdiction for all litigations from this contract shall be Fuerth / Bavaria, Germany. This also applies to lawsuits based on a cheque or bill of exchange.

6. These provisions shall be governed by the Law of the Federal Republic of Germany. The provisions of the UN Purchase Law shall not be applicable. The wording of the German language version of our „General Terms and Conditions of Sale and Delivery“ shall solely be decisive for these General Business Terms.

7. The special terms of our products published with the appropriate price lists shall additionally be applicable.

8. The customer itself shall be responsible to examine the suitability of the goods for the intended final usage.

9. German law (BDSG-Federal Data Protection Law) requires us to inform you that all data of our customers are electronically saved.

As of: 06/2017



Team Aftermarket

Günther Engel, Marco Wiesmann, Sven Gurrath, Carina Ixtlahuac-Olsen,
Yannic Rauner, Sven Felbinger, Katharina Graf

Standorte Aftermarkt

Locations for the aftermarket



MEKRALang GmbH & Co. KG

Buchheimer Str. 4
91465 Ergersheim
Germany
Hotline +49 9847 989 8757
Tel +49 9847 989-0
bestellungen@mekra.de
www.mekra.de



MEKRA Lang International ČR. spol. s.r.o

Družstevní 185
33008 Zruč
Czech Republic
Tel +42 0 377 824-893
Fax +42 0 377 824-893
mekra@mekra.cz
www.mekra.cz



MEKRA Lang do Brasil Ltda.

Avenida Paraná 2879
Cajuruí do Sul - Sorocoba
SP 18105-000
Brazil
Tel +55 15 3235 3420
Fax+55 15 3235 3421
mekra@mekra.com.br
www.mekra.com.br



MEKRA FRANCE SARL

7, rue de la Prévôté
ZA de la Prévôté
78550 HOUDAN
FRANCE
Tel +33 1 30 47 43 85
contact@mekra.fr
www.mekra.fr



MEKRA Lang North America, LLC

101 Tillessen Boulevard
Ridgeway, SC 29 130
U.S.A.
Tel +1 803 337 52 64
Fax +1 803 337 52 65
sales@lang-mekra.com
http://www.lang-mekra.com



MEKRA UK Limited

17 Willowbrook Road
Ham Bridge Trading
Estate BN14 8NA
Worthing,
Great Britain
Tel +44 1903 206106
Fax+44 1903 214395
info@mekra.co.uk



MEKRA Lang Otomotiv Yan Sanayi A.S.

Baskent Organize Sanayi Bölgesi
19. Cad. No: 60
Maliköy Sincan 06909
Ankara
Turkey
Tel +90 312 640 12 16
Fax +90 312 640 12 25
mekratrurkey@mekra-turkey.com
www.mekra-turkey.com

 **Komplettspiegel (Klasse II / IV)**
complete mirror (class II / IV)
rétroviseur complet (class II / IV)
espelho completo (class II / IV)
specchio completo (class II / IV)
espejo completo (class II / IV)
komplett spegel (class II / IV)
kompletní zrcadlo (trída II / IV)
зеркало в комплекте (класс II / IV)
komple ayna (sinif II / IV)
komplett tükör (II / IV tükörsztály)
kompletne lustra (klasa II / IV)

 **Schraube** **parafuso** **skrv** **vida**
screw **vite** **šroub** **csavar**
vis **tornillo** **virint** **sruba**

 **Kugelstange** **kulstang**
ball joint **kulový držák**
bras à rotule **šaravaya opora**
Junta de articulação **ayna destekleyicisi**
staffa con snodo a sfera **golyóvégi rúd**
barra con cabeza esférica **pręt z kulką**

 für 1- / 2- / 3- Spiegelbetrieb (Kabel, Schalter)
pour 1- / 2- / 3- mirror operation (cable, switch)
1 für 1- / 2- / 3- commande(s) (câble, commutateur)
2 para 1 / 2 / 3 espejhos (cabo, interruptor)
3 per 1 specchio / 2 specchi / 3 specchi (cavo, interruttore)
servicio de 1- / 2- / 3- espejo(s) (cable, conmutador)
1- / 2- / 3- spegelstyrning (kabel, styrspek)
pro ovládání 1 zrcadla / 2 zrcadel / 3 zrcadel (kabel, ovladač)
для управления 1 зеркалом / управления 2 / 3 зеркалами
1- / 2- / 3- ayna kumandasi (kablo/salter)
1- / 2- / 3- tükör működtetés (vezérlőkábel, állítókapcsoló)
do obsługi 1, 2 lub 3 lusterek (kabele, przełącznik)

 **Spiegelkopf ohne Glaseinheit (Klasse II / IV)**
mirror head without glassunit (class II / IV)
boîtier, sans glace de rechange (class II / IV)
cabeca de espelho sem unidade de vidro (class II / IV)
carcassa senza vetro (class II / IV)
carcasa, sin unidad de cristal (class II / IV)
spiegelhuvud utan glas (class II / IV)
hlava zrcadla bez skla (trída II / IV)
Зеркала в сборе без зеркального элемента (класс II / IV)
camsız ayna gövdesi (sinif II / IV)
tükörfej tükör és hordozólap nélkül (II / IV tükörsztály)
korpusz lustra bez wkładu (klasa II / IV)

 **Spiegelhalter** **supporto** **несущая опора**
mirror holder **soporte** **ayna tutucusu**
support **hállare** **tükörtartó**
supporte de fixation **držák zrcadla** **uchwył**

 **Stange** **spiegelarm, komplett**
bracket **držák zrcadla**
bras de fixation **трубчатый кронштейн зеркала**
braco de fixação **ayna kolu**
braccio **tükörtartókar**
soporte **wspornik / drążek**

 **manuell verstellbar (Klasse II / IV)**
manually adjustable (class II / IV)
reglage manuel (class II / IV)
manual (class II / IV)
regolazione manuale (class II / IV)
manual (class II / IV)
manuellt justerbar (class II / IV)
manuálně ovládané (trída II / IV)
перевстается вручную (класс II / IV)
manuel olarak ayarlanabilen (sinif II / IV)
kezi állítású (II / IV tükörsztály)
regulowane ręcznie (klasa II / IV)

 **Komplettsystem Klasse II + IV inkl. Spiegelstange**
complete system class II + IV incl. bracket
système complet classe II et IV, bras de rétroviseur compris
sistema completo classe II + IV, suporte incluso
sistema completo classe II + IV completo di braccio
sistema completo classe II + IV, braço incluído
komplettsystem class II + IV inkl. spegelbågar
kompletní systém třídy II + IV včetně držáku zrcadla
Системы класса II + IV включая кронштейн зеркала
komple sistem sinif II + IV tutucu dahil
komplett rendszer II és IV-es osztályú tükörökkel és karral
kompletny system klasy II + IV + ramie lustra

 **Scharnier** **rótula** **knävel** **mafsál**
hinge **cerniera** **závës** **csulópánt**
charnière **rotula** **шарнир** **zawias**

 **Haltebock** **nedre hållare**
lower holder **spodni držák**
support de fixation **держатель**
supporte inferior de fixação **tutucu**
supporto inferiore **csukló**
supporte bajo **uchwył**

 **elektrisch verstellbar (Klasse II / IV)**
remote controlled (class II / IV)
réglage électrique (class II / IV)
elétrico (class II / IV)
regolazione elettrica (class II / IV)
elétrico (class II / IV)
elektriskt justerbar (class II / IV)
elektricky ovládané (trída II / IV)
elektronuupvallemo (класс II / IV)
uzaktan kumandalı (sinif II / IV)
elektronosan állítható (II / IV tükörsztály)
regulowane elektrycznie (klasa II / IV)

 **Busspiegel mit Gelenkarm**
bus mirror with joint arm
rétroviseur de car avec bras articulé
espelho para ônibus com braço articulado
specchio per autobus con braccio snodabile
retrovisor para autocar con brazo articulable
busspiegel med ledad arm
zrcadlo autobusu s kloubovým ramenem
зеркало для автобуса
otobüs aynası
bustükör csuklós karral
lustra autobusu na ramieniu przegubowym

 **Adapter** **adaptador** **adapter** **adaptör**
adapter **adattatore** **adaptér** **adapter**
adaptateur **adaptador** **переходник** **adapter**

 **Aufsteckkeil** **monteringskil**
mounting wedge **nástrčný klin**
semelle de fixation **установочный клин**
cunha desmontável **bağlantı parçası**
supporto a cuneo **ékes csatlakozó**
cuña desmontable **klin do mocowania**

 **Memory-Funktion (Speicherung der Spiegeleinstellung)**
memory function (storage of the position of the mirror)
fonction de mémoire (pour réglage du rétroviseur)
função Memória (memoriza a posição do espelho)
funzione memoria (della posizione dello specchio)
función de memoria (de la posición del espejo)
minnesfunktion (lagring av inställningar)
функция сохранения (мемори)
hafıza fonksiyonu (ayna pozisyonu için)
memória funkcióval (tükör beállításá mentve)
funkcja pamięci (pamięć ustawienia)

 **Busspiegel, hängend**
bus mirror, pendant mounting
rétroviseur de car, montage suspendu
espelho para ônibus com montagem em posição invertida
specchio per autobus, montaggio appeso
retrovisor para autocar, montaje en posición invertida
busspegel, hängande
zrcadlo autobusu visící
зеркало для автобуса, свисающее
otobüs aynası, asılır tip
bustükör függő
lustra autobusu wiszące

 **Aufsteckkeil mit Direktkontakt**
mounting wedge with direct contact
semelle de fixation avec contact direct
cunha desmontável com elemento de contato direto
supporto a cuneo con contatto diretto
cuña desmontable con elemento de cont. directo
monteringskil med direktkontakt
nástrčný klin s přímým kontaktem
установочный клин с прямым электроконтактом
direk temaslı bağlantı parçası
ékes csatlakozó direkt kontaktussal
klin do mocowania z bezpośrednim kontaktem

 **manuell abklappbar**
manually retractable
rabattable manuellement
espelho retrátil manual
ripiegabile manualmente
ababile manualmente
manuellt infällbar
manuálně sklápny
перевстается вручную, откидное
manuel olarak katlanabilme
kézzel behajtható
 ręcznie składane

 **Busspiegel, stehend**
bus mirror, upright mounting
rétroviseur de car, montage posé
espelho para ônibus com montagem em pé
specchio per autobus, montaggio verticale (ritto)
retrovisor para autocar, montaje en posición de pie
busspegel, stående
zrcadlo autobusu stojící
зеркало для автобуса, стоячее
otobüs aynası, dik tip
bustükör álló
lustra autobusu stojące

 **Faltenbalg** **gummibalg**
rubber boot **manžeta**
soufflet de protection **резиновая гофра**
carregador de borracha **körük**
soffietto **gumiharmonika**
guardapolvo **oštona / manczeta**

 **elektrisch abklappbar**
electrically retractable
rabattable électriquement
espelho retrátil elétrico
ripiegabile elettricamente
ababile elettricamente
elektriskt infällbar
elektricky sklápny
перевстается электр., откидное
motorlu olarak katlanabilme
elektronosan behajtható
elektrycznie składane

 **Glaseinheit (Klasse II / IV)**
glass unit (class II / IV)
glace sur support plastique (class II / IV)
unidade de vidro (class II / IV)
vetro con supporto in plastico (class II / IV)
unidad de cristal (class II / IV)
 **glas på platta (class II / IV)** **sklo s deskou (trída II / IV)**
зеркальный элемент с подножкой держателя (класс II / IV)
ayna camı, plastik muhafazalı (sinif II / IV)
tükör hordozólapal (II / IV tükörsztály)
wkład lustra (klasa II / IV)

 **Heizkabel, 2 polig (runder / ovaler Winkelstecker)**
heating cable, double pole (right angle connector, round / oval)
câble chauffant, bipolaire (connexion fiche coudée ronde / ovale)
cabo de aquecimento, bipolar (pino lateral, redondo / ovalado)
cavo, bipolare (attacco 90°, rotondo / ovale)
cable de calefacción, bipolar (clavija lateral, redondo / ovalado)
kabel für uppvärmning, 2-polig (vinkelkontakt rund / oval)
vyhřívací kabel, 2-pólový (kruhová / oválná úhlová zástrčka)
кабель подкл. нагревателя, двухполюсной,
(круглая угловая вилка /)
ısıtıcı kablo, çift kutup (dik açılı konektör, yuvarlak / oval)
2 polusna fűtőkábel ovális / kerek csatlakozóval
przewód grzejny, 2 pin (okrągłe / owalne, wtyczka pod kątem)

 **beheizt (12 / 24 Volt)**
heated (12 / 24 Volt)
chauffant (12 / 24 Volt)
aquecido (12 / 24 Volt)
iscaldato (12 / 24 Volt)
calefactado (12 / 24 Volt)
med värme (12 / 24 Volt)

 **vyhříváné (12 / 24 Volt)**
напр. обогревателя (12/24 вольт)
ısıtıcı (12 / 24 Volt)
fűtött (12 / 24 Volt)
ogrzewanie (12/24 V)

 **Ersatzglas** **vetro di ricambio** **запасное стекло**
spare glass **cristal de repuesto** **ayna camı**
glace de rechange **reservglas** **csere tükörlep**
vidro de reposição **náhradní sklo** **szkło wymienne**

 **Heizfolie** **värmeelement**
heating foil **vyhřívací fólie**
feuille chauffante **нагревательный элемент**
manta aquecedora **ısıtıcı folyo**
resistenza **fűtőfólia**
lámina de calefacción **mata grzewcza**

 **Steuerkabel** **kabel för elstyrning**
control cable **ovládací kabel**
câble de commande **кабель управления**
cabo de controle **kontrol kablou**
cavo di controllo **vezérlőkábel**
cable de control **kabel strowania**

 **Versorgungsleitung** **elkabel**
supply cable **ždrojový kabel**
câble d'alimentation **провод питания**
cabo de alimentação **besleme kablosu**
cavo di alimentazione **betápkábel**
cable distribuidor **przewód zasilania**

 **Spannung (12 / 24 Volt)**
voltage (12 / 24 Volt)
voltage (12 / 24 Volt)
voltage (12 / 24 Volt)
tensione (12 / 24 Volt)
voltaje (12 / 24 Volt)

 **spánning (12 / 24 Volt)**
napětí (12 / 24 Volt)
напряжение (12 / 24 вольт)
volt (12 / 24 Volt)
 feszültség (12 / 24 Volt)
 napięcie (12/24 V)

 **Abdeckung (Klasse II / IV)**
back cover (class II / IV)
cache (class II / IV)
cobertura traseira (class II / IV)
calotta (class II / IV)
pared dorsal (class II / IV)

 **bakstycke (class II / IV)**
zadní kryt (trída II / IV)
задняя крышка корпуса (класс II / IV)
arka kapak (sinif II / IV)
burkolat (II / IV tükörsztály)
pokrywa lustra (klasa II / IV)

 **Spiegelverstellungsschalter** **styrspak**
mirror switch **ovladač zrcadel**
commutateur de rétroviseur **blåk управление**
interruptor do espelho **ayna kumanda düğmesi**
interruttore **tükörállító kapcsoló**
comutador de espejo **przełącznik regulacji**

 **Leistungsaufnahme (Watt)**
power consumption (Watt)
puissance en watt
consumo de energia (Watt)
potenza (Watt)
consumo de energia (wattios)

 **strömförsörjning (Watt)**
píkon (Watt)
потребляемая мощн. (ватт)
güç tüketimi (Watt)
teljesítmény (watt)
pobór mocy (wat)

 **Rahmen** **aro** **ram** **çerçeve**
frame **cornice** **rám** **keret**
cadre **marco** **рама** **rama**

 **kompletter Kabelsatz für elektrisch verstellbare Spiegel**
complete cable set for remote controlled mirrors
kit complet pour réglage électrique
kit completo de cabos para espelhos elétricos
set di cavi per specchi elettrici
juego completo de cables para espejos eléctricos
kabelszat für eljusterbara speglar
kompletní kabelová sada pro elektricky ovládaná zrcadla
полный комплект кабелей с блоком управления для электроуправляемых зеркал
uzaktan kumandalı aynalar için kablo seti
komplett kabelkötég elektronosan állítható tükörkhöz
komplet kabló do lustra sterowanego elektrycznie

 **Wölbungsradius des Spiegelglases**
radius of dishing of the mirror glass ("plan" = flat)
rayon de convexité du verre ("plan" = plat)
Raio de convexidade do vidro ("plan" = plano)
raggio di curvatura dello specchio ("plan" = piano)
radio de convexidad del cristal ("plan" = plano)
böjningsradie på spegelglas („plan" = plöskig)
polomér zakřivení skla zrcadla ("plan" = ploché)
rádius krzywizny szkła zwierka („plan" = płóskий)
bükmény yarçayı ("plan" = düz)
tükör hajlítási sugara („plan" = sík tükör)
promień krzywizny szkła lustra („plan" = płaski)

 **Halteflasche (mit / ohne Schraube)**
clamping device (with / without screw)
collier de fixation (avec / sans vis)
abracadreira (com / sem parafuso)
dispositivo di bloccaggio (con / senza vite)
abrazadera (con / sin tornillo)
klammer (med / utan skruv)
svorka (s / bez šroubu)
серга-держатель / зажимной элемент (с / без винта)
 **Kelepek (vidali / vidasz)**
bilincs (csavarral / csavar nélkül)
objema (z / bez šrubby)

 **Getriebe** **motor** **motor** **motor**
actuator **attuateur** **motorek** **hajtómű**
moteur **motor** **электродпривод** **tryby sterujące**

 **Blinker (-Gehäuse)** **körriktningsvisare**
indicator (housing) **blinker**
incitogant **указатель поворота**
luz de seta (com capa) **sinyal lamba yuvası**
freccia (lampeggiatore) **index (ház)**
intermittente **obudowa kierunkowskazu**

 **Glühbirne** **lampadina** **лампочка**
light bulb **bombilla** **szívalapú**
ampoule **glódlampa** **izzó**
lampoa **žárovka**

 **asphärisch** **asferico** **асферическое**
aspherical **esférico** **асферік**
non-sphérique **asfärisck** **асферичне**
esférico **asfäriscké**

 **Farbe schwarz / grau / chrom**
colour black / grey / chrome
couleur noire / grise / chrome
cor preto / cinza / cromado
color nero / grigio / cromo
color negro / gris / cromo
färg svart / grå / krom
barva černá / šedivá / chromová
цвет: чёрный / серый / хром
renk siyah / gri / krom
fekete / szürke / króm színben
 kolor: czarny / szary / chromowy

Anbau • mounting • assemblage • montagem • montaggio • montaje
montering • montáž • монтаж • montaj • gyűlékezés • montáz

Verwendung • application • aplicação • applicazione • aplicación
anőkán • použití • применение • Kullanimi • alkalmazás • aplicacja

links / rechts einsetzbar
applicable for left / right hand side
applicable à gauche / à droite
aplicável para esquerda / direita
per applicazione sinistro / destro
aplicable para izquierda / derecha
justerbar vänster / höger
použitelné pro levou i pravou / levou/pravou stranu
для применения слева / справа
sol ve sağ tarafa kullanilabilen / sol/sağ tarafa kullanilabilen
bal / jobb oldalra felszerelhető
montáz: strana lewa / prava

Anbau oben / unten
mounting top / bottom
montage haut / bas
montagem superior / inferior
montaggio superiore / inferiore
montaje superior / inferior
Montering upp / ned
montáž nahoru / dolů
монтаж сверху / снизу
montaj üst / alt
felül / alul szerelt
montáz góra / dót

für links / rechts gesteuerte Fahrzeuge
for left / right hand driven vehicles
pour véhicules conduites à gauche / à droite
para veículos conduzidos pela esquerda / direita
per veicoli con guida sinistra / destra
para vehiculos conducidos a la izquierda / a la derecha
föer vänster / högerstyrda fordon
pro levo / pravostraně řízená vozidla
для автомобилей с рулём слева / справа
sol ve sağdan direksiyonlu araçlar için
soldan / sağdan direksiyonlu araçlar için
bal / jobb oldalt vezetett járművekhez
dla ruchu lewo i prawo stronnego

links einsetzbar für rechts gesteuerte Fahrzeuge
applicable left hand side for right hand drive vehicles
applicable à gauche pour véhicules conduites à droite
aplicável para esquerda / veículos conduzidos pela direita
per applicazione sinistro per veicoli con guida destra
aplicable para izquierda / vehiculos conducidos a la derecha
justerbar vänster för högerstyrda fordon
použitelné pro pravou stranu pro levostranně řízená vozidla
для применения справа, в автомобиле с рулём слева
sağdan direksiyonlu araçlar için sol tarafa kullanilabilen
bal oldalra felszerelhető, jobb oldalon vezetett járművekhez
strona lewa dla ruchu prawostronnego

rechts einsetzbar für links gesteuerte Fahrzeuge
applicable right hand side for left hand drive vehicles
applicable à droite pour véhicules conduites à gauche
aplicável para direita / veículos conduzidos pela esquerda
per applicazione destro per veicoli con guida sinistra
aplicable para derecha / vehiculos conducidos a la izquierda
justerbar höger för vänsterstyrda fordon
použitelné pro pravou stranu pro levostranně řízená vozidla
для применения справа, в автомобиле с рулём слева
soldan direksiyonlu araçlar için sağ tarafa kullanilabilen
jobb oldalra felszerelhető, bal oldalon vezetett járművekhez
strona prava dla ruchu lewostronnego

links einsetzbar für links gesteuerte Fahrzeuge
applicable left hand side for left hand drive vehicles
applicable à gauche pour véhicules conduites à gauche
aplicável para esquerda / veículos conduzidos pela esquerda
per applicazione sinistro per veicoli con guida sinistra
aplicable para izquierda / vehiculos conductos a la izquierda
justerbar vänster för vänsterstyrda fordon
použitelné pro levou stranu pro levostranně řízená vozidla
для применения слева, в автомобиле с рулём слева
soldan direksiyonlu araçlar için sol tarafa kullanilabilen
bal oldalra felszerelhető, bal oldalon vezetett járművekhez
strona lewa dla ruchu lewostronnego

rechts einsetzbar für rechts gesteuerte Fahrzeuge
applicable right hand side for right hand drive vehicles
applicable à droite pour véhicules conduites à droite
aplicável para direita / veículos conduzidos pela direita
per applicazione destro per veicoli con guida destra
aplicable para derecha / vehiculos conductos a la derecha
justerbar höger för högerstyrda fordon
použitelné pro pravou stranu pro pravostraně řízená vozidla
для применения справа, в автомобиле с рулём справа
sağdan direksiyonlu araçlar için sağ tarafa kullanilabilen
jobb oldalra felszerelhető, jobb oldalon vezetett járművekhez
strona prava dla ruchu prawostronnego

Fahrzeugbreite
width of vehicle
largeur de véhicule
largura do veiculo
larghezza del veicolo
anchura del vehículo
fordonsbredd
šířka vozidla
ширина автомобиля
araç genişliği
járműlélességig
szeroközű pojazdu

Anbau am Türrahmen
mounting on the door frame
montage cadre portière
montado na porta
montaggio su cornice porta
montaje en el marco de la puerta
montering på dörrkarm
montáž na rám dveří
монтаж на раму двери
araç kapı çerçevesine montaj
ajtkeretre szerelhető
montaż na drzwiach

integrierter Halter
integrated holder
support intégré
suporte de fixação integrado
supporto integrato
soporte integrado
integrerad hållare
integrováná montáž
интегрированный
tűmlesztik ayna tutucusu
integrált tartó
zintegrowany uchwyty

Winkelstellung
angularity
angle de fixation
ángulo
angolatura
angularidad
winkel
űhel nastaveni
yrol
açı pozisyonu
szögállás
położenie
kątowe

Material • matériel • materiale • material
материал • materiyal • anyag • materiaľ

ABS Spiegelgehäuse: Kunststoff ABS (schwarz / grau)
mirror housing: plastic ABS (black / grey)
boîtier: matière plastique ABS (noir / argenté)
carcaça: plástico ABS (preto / cinza)
carcassa: plastica ABS (nero / grigio)
carcasa: plástico ABE (negro / gris)
spegelhus: plast ABS (svart / grå)
skořepina zrcadla: umělá hmota ABS (černá / šedivá)
корпус зеркала: пластмасса ABS (цвет чёрный / серый)
ayna gövdesi plastik ABS (siyah / gri)
tükörház ABS-ből (fekete / szürke)
obudowa lustra: tworzywo ABS (kolor czarny / szary)

ASA Spiegelgehäuse: Kunststoff ASA, schwarz
mirror housing: plastic ASA, black
boîtier: matière plastique ASA, noir
carcaça: plástico ASA, preto
carcassa: plastica ASA, nero
carcasa: plástico ASA, negro
spegelhus: plast ASA, svart
skořepina zrcadla: umělá hmota ASA, černá
корпус зеркала: пластмасса АСА, цвет чёрный
ayna gövdesi plastik ASA, siyah
tükörház ASA-ből, fekete
obudowa lustra: tworzywo ASA, kolor czarny

PP Spiegelgehäuse: Kunststoff PP (Polypropylen), schwarz
mirror housing: plastic PP (polypropylene), black
boîtier: matière plastique PP (polypropylène), noir
carcaça: plástico PP (polipropileno), preto
carcassa: plastica PP (polipropilene), nero
carcasa: plástico PP (polipropileno), negro
spegelhus: plast PP (polypropylen), svart
skořepina zrcadla: umělá hmota PP (Polypropylen), černá
корпус зеркала: пластмасса Полипропилен, цвет чёрный
ayna gövdesi plastik PP (Polipropilen), siyah
tükörház PP-ből, fekete
obudowa lustra: tworzywo PP (polipropylen), kolor czarny

PC Spiegelgehäuse: Kunststoff PC (Polycarbonat) schwarz
mirror housing: plastic PC (Polycarbonat) black
boîtier: matière plastique PC (Polycarbonat) noir
Carcaça: plástico PC (Policarbonato) preto
carcassa: plastica PC (Polycarbonato) nero
carcasa: plástico PC (Polycarbonato) negro
spegelhus: plast PC (Polycarbonat) svart
skořepina zrcadla: umělá hmota PC (Polycarbonat) černá
корпус зеркала: пластмасса Поликарбонат, цвет чёрный
ayna gövdesi plastik polycarbonat siyah
tükörház PP-ből, fekete
obudowa lustra: tworzywo PC (poliwęglan), kolor czarny

PU Spiegelstange umschäumt mit PU (Polyurethan)
mirror bracket foamed with PU (polyurethan)
le bras du rétroviseur est recouvert de polyuréthane
Braço revestido de espuma sintética PU (Poliuretano)
braccio schiumato con PU (polyurethan)
brazo revestido de espuma sintética PU (Polyuretano)
spegelarm i skumformad PUR (polyuretan)
trubka držáku zpětného zrcadla zalisovaná v Polyurethanu
брус зеркала покрытый ПУ (полиуретаном)
ayna kolu polyüretan kaplı
tükörtartó kar habosított PU-val borítva
ramię lustra wyścietiane PU (poliuretan)

verzinktes Stahlblech
galvanized sheet steel
boîtier en tôle zinguée
chapa de aço galvanizada
acciaio zincato
carcasa de chapa de acero galvanizada
galvaniserad plát
pozinkovaný plech
оцинкованная листовая сталь
galvanizált metal plaka
horganyzott acéllemez
blacha ocynkowana

Stahlrohr
steel tube
tube en acier
tubo de aço
tubo in acciaio
tubo de acero
stálrör
ocelová trubka
стальная трубка
çelik boru
acélcső
rura stalowa

Alu Aluröhre
aluminium tube
tube en aluminium
tubo de aluminio
tubo de alluminio
tubo de aluminio
aluminiumrör
hliníková trubka
alüminium boru
alucső
rura aluminiowa

Zeitraum • space of time • espace de temps • período de tempo
periodo di tempo • espacio de tiempo • period • období
период времени • dőnem • időbeni kiterjesztés • okres czasu

verwendbar ab Baujahr ... des Fahrzeugs (Monat / Jahr)
usable from year of production ... of the vehicle (month / year)
utilisable à partir de l'année ... du véhicule (mois / an)
aplicado a partir da data de produção do veículo (mês / ano)
utilizzabile dall'anno di produzione del veicolo (mese / anno)
utilizable desde el año de fabricación del vehículo (mes / año)
användbar för fordon med produktionsår from (månad / år)
použitelné od roku výroby vozidla (měsíc / rok)
применять до года изготовления (год / месяц)
Aracın üretim yılından sonra kullanilabilir (ay / yıl)
alkalmazható évjáratig (év / hónap)
rok budowy pojazdu od ... (miesiąc / rok)

verwendbar bis Baujahr ... des Fahrzeugs (Monat / Jahr)
usable until year of production ... of the vehicle (month / year)
utilisable jusqu'à l'année ... du véhicule (mois / an)
aplicado até a data de produção do veículo (mês / ano)
utilizzabile fino all'anno di produzione del veicolo (mese / anno)
utilizable hasta el año de fabricación del vehículo (mes / año)
användbar för fordon med produktionsår to (månad / år)
použitelné do roku výroby vozidla (měsíc / rok)
применять до года изготовления (год / месяц)
Aracın üretim yılına kadar kullanilabilir (ay / yıl)
alkalmazható évjáratig (év / hónap)
rok budowy pojazdu do ... (miesiąc / rok)

Zeitraum
space of time
espace de temps
período de tempo
periodo di tempo
espacio de tiempo
period
období
период времени
dőnem
időbeni kiterjesztés
okres czasu

Spiegelklassen • mirror classes • classes de rétroviseurs • classes de espelhos
classi di specchio • classes de retrovisores • spegellasser • třídy zrcadel
klassy zerkal • ayna siniflari • tükörsztályok • klasy luster

I Spiegelklasse I (Innenspiegel)
mirror class I (interior mirror)
rétroviseur classe I (miroir intérieur)
espelho classe I (espelho interior)
specchio classe I (specchio interno)
espejo clase I (espejo interior)
spegelklass I (innerspegel)
zrcadlo třídy I (zrcadlo vnitřní)
зеркало класс I (внутреннее зеркало)
sinif I ayna (iç ayna)
I tükörsztály (belső tükör)
lustra klasy I (wsteczne)

II Spiegelklasse II / III (Hauptspiegel)
mirror class II / III (main mirror)
rétroviseur classe II / III (rétroviseur principal)
espelho classe II / III (espelho principal)
specchio classe II / III (retrovisore principale)
espejo clase II / III (espejo principal)
spegelklass II / III (huvudspegel)
zrcadlo třídy II / III (zrcadlo hlavní)
зеркало класс II / III (главное зеркало)
sinif II / III ayna (ana ayna)
II / III tükörsztály (főtükör)
lustra klasy II / III (głównie)

IV Spiegelklasse IV (Weitwinkelspiegel)
mirror class IV (wide angle mirror)
rétroviseur classe IV (rétroviseur grand angle)
espelho classe IV (espelho auxiliar)
specchio classe IV (coppa grandangolo)
espejo clase IV (espejo de gran ángulo)
spegelklass IV (vidvinkelspegel)
zrcadlo třídy IV (zrcadlo širokouhlé)
зеркало класс IV (широкоугольное зеркало)
sinif IV ayna (geniş görüş aynası)
IV tükörsztály (nagy látószögű tükör)
lustra klasy IV (szerokokątne)

V Spiegelklasse V (Rampenspiegel)
mirror class V (roof mirror)
rétroviseur classe V (miroir d'accostage)
espelho classe V (espelho de rampa)
specchio classe V (specchio guardaruota)
espejo clase V (espejo de rampa)
spegelklass V (närskiktspegel)
zrcadlo třídy V (zrcadlo rampové)
зеркало класс V (зеркало для рамы)
sinif V ayna (kapı üstü aynası)
V tükörsztály (rampatükör)
lustra klasy V (rampowe)

VI Spiegelklasse VI (Frontspiegel)
mirror class VI (front-under mirror)
rétroviseur classe VI (miroir frontal)
espelho classe VI (espelho frontal)
specchio classe VI (guardaruota anteriore)
espejo clase VI (retrovisor para parte frontal del vehículo)
spegelklass VI (frontspiegel)
zrcadlo třídy VI (zrcadlo čelní)
зеркало класс VI (фронтальное зеркало)
sinif VI ayna (ön tapın aynası)
VI tükörsztály (fronttükör)
lustra klasy VI (przednie)

II + IV Spiegelsystem Klasse II + IV
(Hauptspiegel + Weitwinkelspiegel)
mirror system class II + IV
(main mirror + wide angle mirror)
système de rétroviseurs classe II + IV
(rétroviseur principal + rétroviseur grand angle)
espelho classe II + IV
(espelho principal + espelho auxiliar)
sistema di specchi classe II + IV
(retrovisore principale + coppa grandangolo)
sistema de retrovisores classe II + IV
(espejo principal + espejo de gran ángulo)
spiegelsystem klass II + IV
(huvudspegel + vidvinkelspegel)
systém zpětných zrcadel třídy II + IV
(zrcadlo hlavní + zrcadlo širokouhlé)
Система зеркал класс II + IV
(главное + широкоугольное зеркало)
sinif II + IV ayna sistemi
(ana ayna + geniş görüş aynası)
tükörrendszér II és IV osztályok tükörökkel
(fő és nagy látószögű tükörökkel)
system lusterek klasy II + IV
(głównie + szerokokątne)

II + V Spiegelsystem Klasse II + V
(Hauptspiegel + Rampenspiegel)
mirror system class II + V
(main mirror + roof mirror)
système de rétroviseurs classe II + V
(rétroviseur principal + miroir d'accostage)
espelho classe II + V
(espelho principal + espelho de rampa)
sistema di specchi classe II + V
(retrovisore principale + specchio guardaruota)
sistema de retrovisores classe II + V
(espejo principal + espejo de rampa)
spiegelsystem klass II + V
(huvudspegel + närskiktspegel)
systém zpětných zrcadel třídy II + V
(zrcadlo hlavní + zrcadlo rampové)
Система зеркал класс II + V
(главное + зеркало для рамы)
sinif II + V ayna sistemi
(ana ayna + kapı üstü aynası)
tükörrendszér II és V osztályok tükörökkel
(fő és rampa tükörökkel)
system lusterek klasy II + V
(głównie + rampowe)

EGE EG- / ECE - gerecht
according to EEC-norm
conforme aux normes / CE
conforme normas da CE
a norma CEE
conforme a las normas CE
EG-godkänd
splňuje normy EU
соответствует нормам ECE
EEC normlarına uygundur
EG / ECE -nek megfelelő
zgodne z EC / ECE

Katalogseite
catalogue page
page du catalogue
página do catálogo
oldal a katalógusban
página catálogo
Katalogsida
strana katalogu
страница каталога
katalóg sayfasi
oldal a katalógusban
strona w katalogu

WIKIKANG - passion for excellence.

MEKRA Lang - passion for excellence.

Contents are subject to change
Last Update: April 2024
www.mekra.de

