



2024

Electronics and Accessories

Product Catalog for Camera Monitor Systems and Active Alarm Systems



Creating a larger perspective –
with vision solutions by MEKRA Lang

Preface

Dear Customers,

We are delighted that you are looking at our new "Electronics and Accessories" product catalog for the independent aftermarket.

With our decades-long experience in the automotive sector, MEKRA Lang has become not only the global leader in manufacturing mirror systems for commercial vehicles, but also a specialist for camera monitor systems.

Thanks to our indirect vision expertise and our focus on innovation, we have become the trusted partner of virtually all leading commercial vehicle manufacturers, contributing significantly to the improvement of traffic safety.

Our premium products are also highly regarded in the independent aftermarket and provide the same uncompromising quality as parts produced by the vehicle manufacturer.

For decades we have been supporting this aftermarket with services and promotional tools. At the same time, we consistently ensure the delivery of original and tested accessories. Not only do our reliable products offer significant added value, they also provide the user with enormous practical benefits.

We have redesigned the catalog to facilitate finding and selecting the appropriate camera monitor system. Using the installa-

tion scheme depicted, you will quickly find the appropriate product for the vehicle in question.

We are delighted to provide you with our expanded product portfolio which covers a wide range of different requirements.

As is the case for all MEKRA product information, you can find the new catalog in electronic format on our homepage www.mekra.de. Additionally, the convenient authorized dealer search function allows all customers and end users to find a competent contact person near them.

With kind regards from Ergersheim
Your Aftermarket Team





Content

Development, Technology, and Information	06 – 11	Electronics and Accessories	32 – 77
Value-added Camera Monitor Systems and Active Alarm Systems	06 – 07	Adaptation Solutions for Existing Displays / Commercial Vehicles	
Camera Monitor Systems	08	Vehicle manufacturers	48 – 59
Electronics Expertise	09	DAF	48
Systems for Increased Efficiency and Safety at Work		IVECO	49
Blind Spot Assistant	10	MAN	50 – 52
Turn Assist System AAS 1312	11	MERCEDES-BENZ	53 – 54
		RENAULT	55
		SCANIA	56 – 57
		VOLVO	58
		VOLKSWAGEN (VW)	59
		Astrata, FleetBoard and TomTom	60
		Displays with cinch interface	61
Sample Installations	12 – 31	Adaptation Solutions for Existing Displays / Agricultural Machines	
Active Alarm Systems		Vehicle manufacturers	62 – 64
Turn Assist System AAS 1312	14 – 15	CNH	62
		FENDT	63
		JOHN DEERE	64
		Isobus / Müller Elektronik	65
Commercial Vehicles		Cables and Connections	
Single-unit Vehicle	16 – 17	Direct connecting cables and multi cables	66 – 67
Tractor-Trailer	18 – 19	Trailer connecting cables for 1 camera	68
Semi Truck	20 – 21	Trailer connecting cables for 2 cameras	69
Tanker Trailer	22 – 23		
Agricultural Machines		Camera Monitor System Accessories	70 – 73
Farm Tractor	24 – 25		
Farm Tractor with Trailer	26 – 27		
Construction Equipment		Turn Assist System AAS 1312 and Accessories	
Crawler and Wheel Excavator	28 – 29	Kits	74
Wheel and Crawler Loader	30 – 31	Radar sensor mounting brackets	75
		Extension cables	75
		Spare parts	76
		Appendix	78 – 91
Electronics and Accessories	32 – 77	Cross-reference-tables	
Introduction	34 – 35	MEKRAtronics – MEKRA Cross-reference-table / Product Overview	80 – 83
Basic Considerations Regarding Product Selection	36 – 37	OE Numbers – MEKRA Cross-reference-table	84 – 86
Cameras and Camera Accessories			
CMOS camera and accessories	38 – 39	Notes	87
CMOS spherical camera and accessories	40 – 41	Funding Programs	88
Analog platform camera / shutter camera and accessories	42 – 45	Aftermarket Locations	89
Monitors and Monitor Accessories	46 – 47	General Terms and Conditions	90 – 91

Value-added Camera Monitor Systems and Active Alarm Systems

Sample applications

Both **safety** and **efficiency** can be increased by using camera monitor systems and active alarm systems. In this context, it is of critical importance to choose the right components as well as the best installation location. A solution that is tailored to the corresponding application benefits the driver not only in terms of **ergonomics** but also in terms of general **health**. An additional benefit that is of great importance is the increased **comfort** level.

That is why you should choose MEKRA Lang products, your partner for safety and efficiency at work.

Front View Camera

We make sure that your view of the area in front of the vehicle is optimized. To this end, the camera is attached to the front of the driver's cab. By installing a second camera, visibility of the work area can be further enhanced, increasing the driver's ergonomic comfort while decreasing his/her stress level and making work processes more efficient. This is particularly relevant in situations in which the visibility of the front mirror is impaired by the vehicle body.

For sample installations, see p. 18 and 30



Rear View Camera

A rear view camera provides excellent visibility of areas behind the vehicle which cannot be seen directly or by using mirrors. An aperture angle of 100° or 120° is ideal. This facilitates maneuvering the vehicle and helps prevent accidents. Thanks to **ADR tested** ABS connections, this solution can be applied to all vehicles.

For a sample installation, see p. 16 et seq.



Blind Spot Assistant

The side view camera which is part of the Blind Spot Assistant, enlarges the field of vision to the side of the vehicle. Due to the ergonomic orientation of the monitor, the driver is able to see the hazard zone at a glance. This makes it significantly easier to detect pedestrians, cyclists and objects in the vehicle's blind spot.

For a sample installation, see p. 16



Additional information

Blind Spot Assistant
→ p. 10

Hitch Plate Camera

This camera assists the driver during the trailer hitching process. Using an aperture angle of 100°, the king pin is perfectly visible and time-consuming maneuvering can be avoided. This camera can also be purchased with integrated distance lines which makes it easier to gauge clearances.



Work Area Camera plus Rear View Camera

Work area cameras are useful for monitoring work processes, such as loading and unloading operations. For monitoring the load distribution of bulk cargoes e.g., a work area camera with an aperture angle of 70° is recommended. Combining a work area camera with a rear view camera results in a significant acceleration of work processes. Accidents and damage can thus be prevented.

For a sample installation, see p. 20



Turn Assist System AAS 1312

The radar-based system triggers alerts when cyclists or other vehicles are moving within the hazard zone next to the vehicle. False alerts are kept to a minimum.

For a sample installation, see p. 14



Additional information
Turn Assist System AAS 1312
→ p. 11

Camera Monitor Systems

Installation and use

What You Should Know

The quality offered by MEKRA Lang's camera monitor systems is second to none. Even under the most difficult conditions, including back-light or darkness, they produce images of superior clarity. Our extensive product portfolio enables us to cover a wide range of applications. We are committed to provide you with the best solution for your requirements.

Monitor Position

By utilizing various mounting brackets, the monitor's installation position can be optimized according to the ergonomic requirements of the operator. The optimal position from an ergonomic point of view could be in the center of the driver's cab or on the A-pillar on the right side (e.g. for a side view camera). It is important to remember that the further away the monitor is from the driver's eyes, the smaller objects will appear.

Camera Position

MEKRA cameras are available with various aperture angles which – depending on mounting position and requirements – provide an ideal representation of the targeted field of vision. Please consider the following: While a larger aperture angle extends the total area displayed, objects will appear smaller.

Low Distortion

You will notice that the product description of several camera models contains the keyword "low distortion".

This term refers to using a special processing technique for images which would normally appear distorted (also known as "fish-eye effect").

The illustrations on the right clearly show the difference between a "distorted" image (top) and a low-distortion image (bottom).



Camera Image

The following examples illustrate the differences between the individual aperture angles.

28° aperture angle



70° aperture angle



100° aperture angle



120° aperture angle



Electronics Expertise

From development to production

MEKRA Lang runs its own development division at the company's Ergersheim location. This is where we develop and manufacture our cameras according to OE standards. During every phase of development, the various practical use cases are taken into account to achieve the best product results.

MEKRA cameras represent a particularly high level of technological development. Rather than employing traditional CCD sensors, which are often plagued by streaking/blooming and smear effects, our cameras are equipped with **CMOS sensors**. Due to their optimized configuration these sensors offer the same light sensitivity as traditional CCD cameras.

MEKRA cameras feature a particularly rugged housing which makes them perfectly suited for rough environmental conditions. Thanks to special seals and fully molded connecting cables these cameras meet the rigorous ingress protection requirements of protection class **IP 69 K** which even allows them to be cleaned using high-pressure cleaner.

And thanks to their high-performance integrated **heating system**, which de-ices the lens within just a few minutes, the cameras can be operated under even the most extreme weather conditions.

Consistently excellent vision is ensured by using the platform camera with a mounting bracket that is equipped with an **automatic shutter (shutter camera bracket)**. It covers the lens while the vehicle is in motion to protect the lens from dirt and debris. As soon as the driver goes into reverse, the shutter opens and the driver is provided with the best possible view through the clean camera.

Our Cameras

CMOS camera

See p. 38



CMOS spherical camera

See p. 40



Analog platform camera

See p. 42



Analog platform camera / shutter camera

See p. 44



Exploded View of the Platform Camera

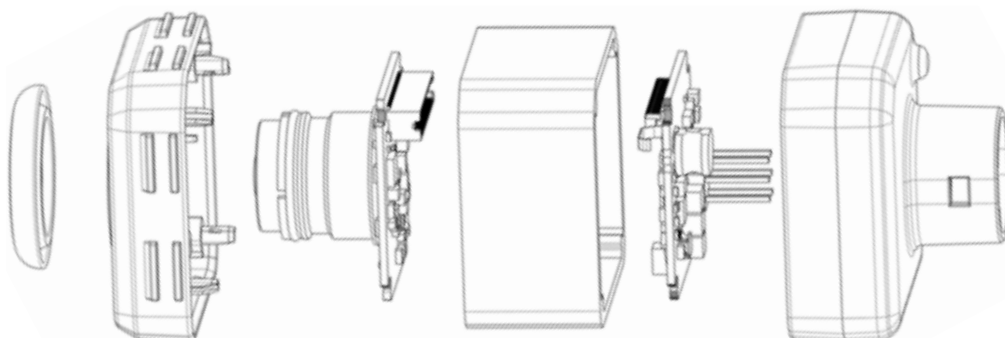

Systems for Increased Efficiency and Safety at Work

Introducing the latest technologies



Blind Spot Assistant

Making a right turn at an intersection requires the commercial vehicle driver's full attention. Cyclists and pedestrians find themselves in dangerous situations, especially when making eye contact is impossible.

The Blind Spot Assistant can help reduce the number of turning accidents causing property damage or injuries and increases the safety of all road users involved.

The camera of the Blind Spot Assistant is attached on the side of the driver's cab and covers the entire critical area on the right side of the vehicle. This enables the driver to assess the situation faster and more accurately. The side view camera is automatically activated via the speed or the turn signal.

The camera image can be displayed either on the on-board monitor via the con-

trol box or a high-quality MEKRA monitor. In any case, the assistant offers a less distorted image of objects and a significantly larger field of vision than the roof mirror.

Specifications:

Monitor

- Resolution: 800 x 480 pixels
- Operating voltage: 12 / 24 V
- Camera inputs: 4, split screen available.
- Protection class: IP 65
- Video format: PAL / NTSC

Camera

- Operating voltage: 10 - 36 V
- Operating temperature: -40 °C to +85 °C
- Image resolution: 720 x 486 pixels
- Aperture angle: 120°
- Protection class: IP 69 K
- Video format: PAL / NTSC
- Shock resistance: 50 G

For a sample installation, see p. 16



Both the control box and the monitor can be used to expand this system to include up to four cameras. For example, safety around the vehicle can be increased by employing the rear view camera. Turn signals, reverse gear or other vehicle signals can be used for activation.

We offer a comprehensive portfolio of adaptation solutions for the control box (p. 48 et seq.)

You might also want to have a look at "MEKRA Lang Vision Solutions for the Logistics Sector" on YouTube!



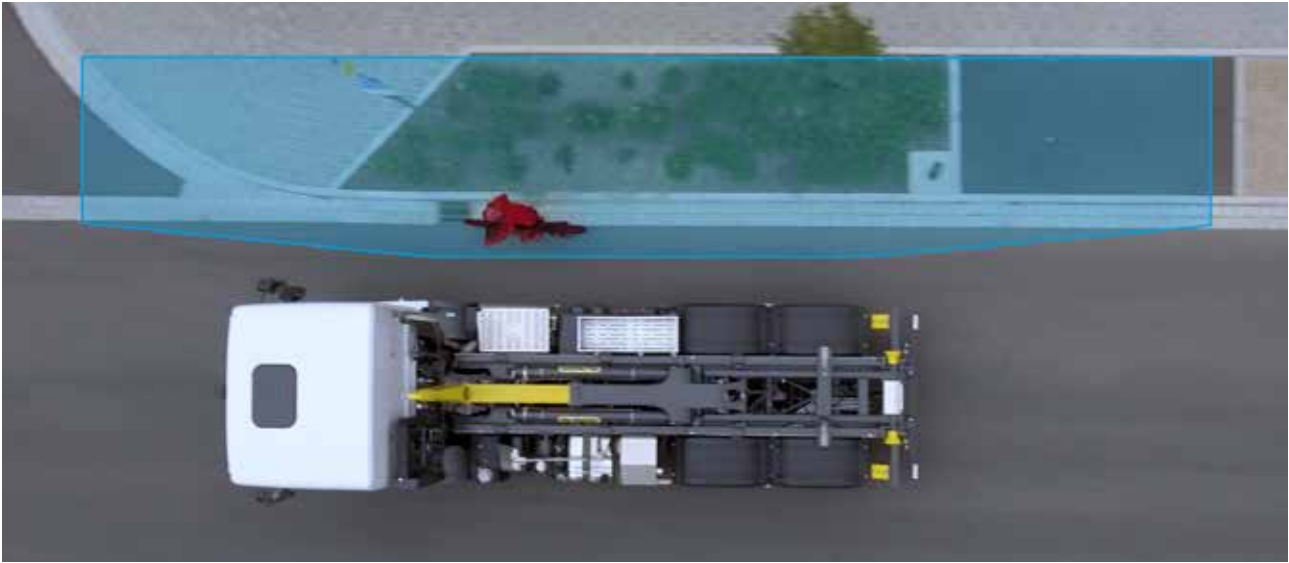

Turn Assist System AAS 1312

The AAS GPS / CAN turn assist system is based on the PRECO Preview Side Defender® II radar sensor. The object detection system alerts drivers of medium-size and heavy-duty vehicles (>3.5t) when vulnerable road users are in the danger zone next to the vehicle.

Thanks to its intelligent operating modes, the AAS triggers alerts when cyclists or other vehicles enter the detection zone. False alerts due to stationary objects are kept to a minimum.

The radar sensor features a built-in self test (BIST) function. Specifically developed for this application, the wide horizontal field of vision (up to +/-85°) covers an area approximately 12m long and 3m wide next to the vehicle. The sensor detects and classifies multiple objects at the same time. Depending on the situation, it differentiates between stationary and moving objects. That is why the sensor can also be

used as a lane-change assistant at higher speeds.

The in-cab display on the A-pillar provides the driver with reliable visual and audible alerts when potential dangers arise next to the vehicle. Additionally, all system function status reports are displayed here.

Specifications:

Sensor

- Operating voltage: 9 - 33 V
- Operating temperature: -40 °C to +85 °C
- Frequency range: 24 GHz
- Protection class: IP 69 K
- Shock resistance: 25 G

Display

- Operating temperature: -40 °C to +85 °C
- Protection class: IP 67
- Power supply: via radar sensor
- Shock resistance: 10 G

For a sample installation, see p. 14



The sensor can handle tough environmental conditions and works during the day and at night.

The vehicle speed is essential for the accurate assessment of a given traffic situation. It is provided in one of two ways: by an active GPS antenna or the vehicle's own CAN bus. The CAN bus version requires a fleet management interface within the vehicle.

Installation videos for the Turn Assist System are available on our YouTube channel!





Sample Installations

Active Alarm Systems

Turn Assist System AAS 1312	14 – 15
-----------------------------	---------

Commercial Vehicles

Single-unit Vehicle	16 – 17
Tractor-Trailer	18 – 19
Semi Truck	20 – 21
Tanker Trailer	22 – 23

Agricultural Machines

Farm Tractor	24 – 25
Farm Tractor with Trailer	26 – 27

Construction Equipment

Crawler and Wheel Excavator	28 – 29
Wheel and Crawler Loader	30 – 31

Turn Assist System AAS 1312

Vehicle shown is an example



Additional information
Turn Assist System AAS 1312
→ p. 11



Installation Plan for Turn Assist System AAS 1312, GPS and CAN Versions



For additional information on our radar sensor mounting brackets, please see p. 75.



Single-unit Vehicle

MEKRA rear view camera system and Blind Spot Assistant



Additional information
Blind Spot Assistant
→ p. 10



Installation Plan for Increased Efficiency and Safety at Work

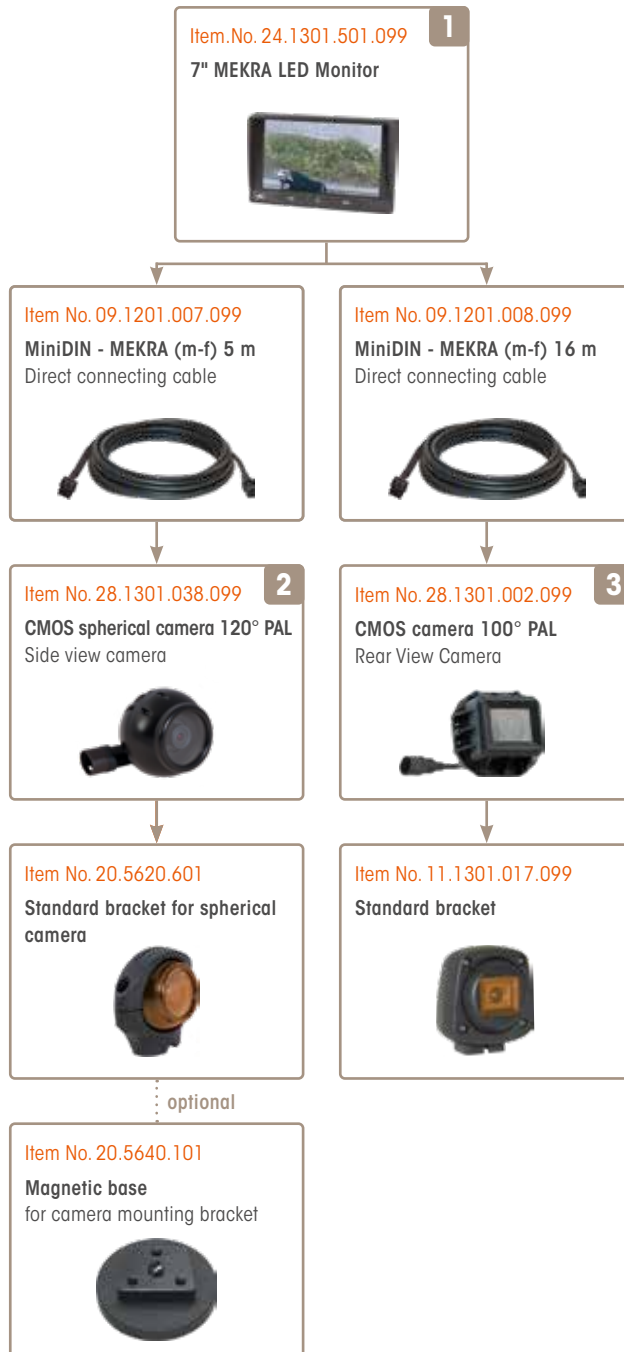

Tractor-Trailer

MEKRA triple camera system



Installation Plan for Increased Efficiency and Safety at Work



Semi Truck

MEKRA dual camera system on semi-trailer



Installation Plan for Increased Efficiency and Safety at Work



Tanker Trailer

MEKRA rear view camera system





Farm Tractor

MEKRA rear view camera system



Installation Plan for Increased Efficiency and Safety at Work

Item No. 24.1301.501.099 **1**
7" MEKRA LED monitor



Item No. 09.1301.003.099
AMP - MEKRA (f-f) 5 m
Direct connecting cable



Item No. 28.1301.002.099 **2**
CMOS camera 100° PAL
Rear View Camera



Item No. 11.1200.502.099
Mounting bracket
with protective hood



optional

Item No. 20.5640.101
Magnetic base
for camera mounting bracket



Farm Tractor with Trailer

MEKRA rear view camera system



Installation Plan for Increased Efficiency and Safety at Work



Crawler and Wheel Excavator

MEKRA dual camera system



Installation Plan for Increased Efficiency and Safety at Work



Wheel and Crawler Loader

MEKRA dual camera system



Installation Plan for Increased Efficiency and Safety at Work





Electronics and Accessories

Introduction	34 – 35
Basic Considerations Regarding Product Selection	36 – 37
Cameras and Camera Accessories	
CMOS camera and accessories	38 – 39
CMOS spherical camera and accessories	40 – 41
Analog platform camera / shutter camera and accessories	42 – 45
Monitors and Monitor Accessories	46 – 47
Adaptation Solutions for Existing Displays / Commercial Vehicles	
Vehicle manufacturers	48 – 59
DAF	48
IVECO	49
MAN	50 – 52
MERCEDES-BENZ	53 – 54
RENAULT	55
SCANIA	56 – 57
VOLVO	58
VOLKSWAGEN (VW)	59
Astrata, FleetBoard and TomTom	60
Displays with cinch interface	61
Adaptation Solutions for Existing Displays / Agricultural Machines	
Vehicle manufacturers	62 – 64
CNH	62
Fendt	63
John Deere	64
Isobus / Müller Elektronik	65
Cables and Connections	
Direct connecting cables and multi cables	66 – 67
Trailer connecting cables for 1 camera	68
Trailer connecting cables for 2 cameras	69
Camera Monitor System Accessories	70 – 73
Turn Assist System AAS 1312 and Accessories	
Kits and accessories 1312	74
Radar sensor mounting brackets 1312	75
Extension cables 1312	75
Spare parts 1314	76

Introduction

Electronics and accessories

Symbols

Connectors



Monitors

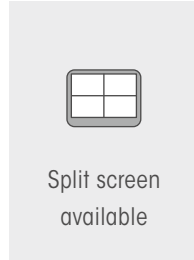
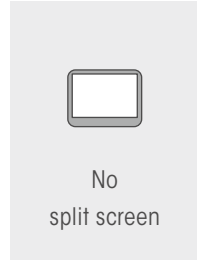

Adaption Solutions

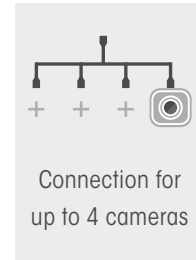
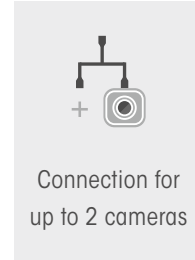
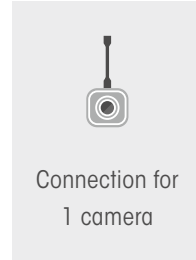

Guide for Adaptation Solutions

The adaptation products have been assigned to sub-categories by vehicle manufacturer or alternative GPS and telematics systems to help you select the appropriate adaptation solution. An adaptation matrix precedes the products so that you can see which adapter cable or control box you need depending on the type of display, model year, vehicle, camera pre-fitting and number of cameras. The adaptation matrix follows the scheme listed below.

Adaptation Matrix

Display / Model Year/ Vehicle					
Camera pre-fitting	Adaptation solution for 1 camera	Adaptation solution for 2 cameras	Adaptation solution for 3 cameras	Connector system	Video format
Camera pre-fitting code e.g. 351 LZ	Adapter cable or control box x item no.	Adapter cable or control box x item no.	Adapter cable or control box x item no.	e.g. AMP	NTSC / PAL

Why do some cables have a grommet?

The ingress protection rating for MEKRA cameras and connectors is IP 69 K. In order to comply with the rating requirements at all times, the analog platform camera is equipped with an additional rubber grommet. It is pre-attached to the respective cable and simply needs to be pushed against the camera housing once the connector has been plugged in (see figure for an example).

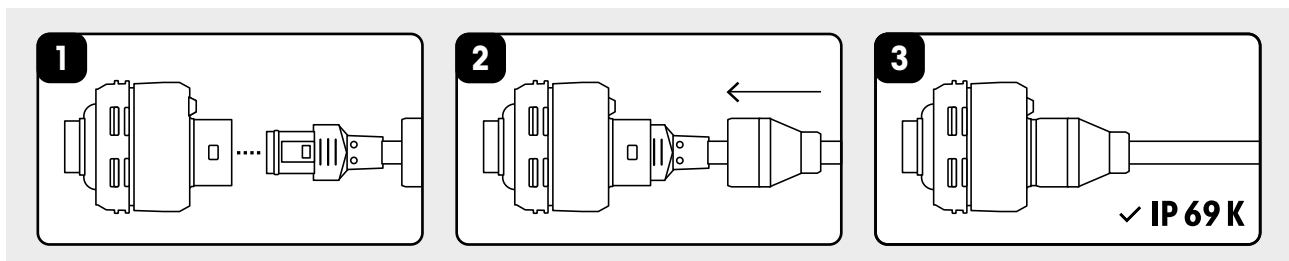
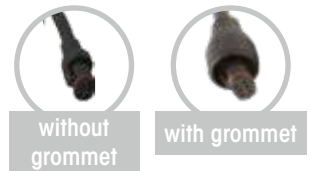

Connectors

The different connector types are color-coded for better clarity. They are also identified as "male" (m) and "female" (f) to facilitate correct matching.

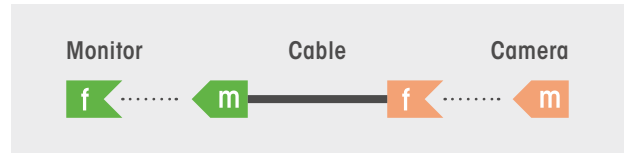

Overview of the Most Important Connectors

ABS connectors



MEKRA connectors



MiniDIN HD connectors



MiniDIN connectors



AMP connectors



Additional connector types:

Binder

Other

Basic Considerations Regarding Product Selection

Answer a few questions to find the best vision solution for your needs

Question 1: What type of vehicle is it?

Single-unit Vehicle



Sample installations, p. 14 et seq.

Tractor-Trailer



Sample installation, p. 18

Semi Truck



Sample installation, p. 20

Tanker Trailer



Sample installation, p. 22

Farm Tractor



Sample installation, p. 24

Farm Tractor with Trailer



Sample installation, p. 26

Crawler / Wheel Excavator



Sample installation, p. 28

Wheel / Crawler Loader



Sample installation, p. 30

Other

Question 2: How many cameras are to be installed?

1 camera



2 cameras



3 cameras



4 cameras



Electronics Expertise

Go here to find out more about what distinguishes our camera development and technical extras
→ p. 9



Kameras & Kamerazubehör

Go here to find our product portfolio of cameras and matching accessories, e.g. camera brackets, magnetic bases and adapter cables. → p. 38 et seq.

Question 3: Where will the camera/s be installed

Camera 1

- Front view camera
- Side view camera (= 120°)
- Rear view camera (Over 2m = 100°, less than 2m = 120°)
- Work area camera (e.g. dump box = 70°)

Camera 2

- Front view camera
- Side view camera (= 120°)
- Rear view camera (Over 2m = 100°, less than 2m = 120°)
- Work area camera (e.g. dump box = 70°)

Camera 3

- Front view camera
- Side view camera (= 120°)
- Rear view camera (Over 2m = 100°, less than 2m = 120°)
- Work area camera (e.g. dump box = 70°)

Camera 4

- Front view camera
- Side view camera (= 120°)
- Rear view camera (Over 2m = 100°, less than 2m = 120°)
- Work area camera (e.g. dump box = 70°)



Value-added Camera Monitor Systems and Active Alarm Systems

Go here to find out more about the advantages of front view, side view, work area and rear view cameras. → p. 6 et seq.



Sample Installations

Go here for an overview of all sample installations sorted by vehicle categories.
→ p. 13 et seq.

Question 4: Will the camera/s be connected to an existing display or is a monitor to be installed?

Existing display



Please go to question **5**

Separate monitor



Please go to question **6**



Monitors & Accessories

Go here for our portfolio of monitors and respective accessories, e.g. various monitor brackets and a control box for trailer detection.
→ p. 46 et seq.

Question 5: Do you know the camera pre-fitting code or the type of display?

Camera pre-fitting

- 351 LZ**
(MAN, MMT1 → p. 50–52)
- 351 ME / 351 MF**
(MAN, MMT2 → p. 50–52)
- OP2D1 / OP2D3 / OPHIK**
(MAN, MMT3 → p. 50–52)
- 632KM** (MAN TGE → p. 52)
- J9J / J9P** (Mercedes-Benz → p. 53–54)
- 3YS02** (Renault → p. 55)
- BUPMON / MCA-A**
(Volvo → p. 58)
- KA8** (VW → p. 59)

Display type

- TNR 5"** (DAF → p. 48)
- IVECONNECT / HI-CONNECT**
(IVECO → p. 49)
- Premium Radio 5" / Infotainment Premium 7"**
(Scania → p. 56–57)
- Astrata / FleetBoard / TomTom** (→ p. 60)
- Displays with cinch interface**
(→ p. 61)



Adaptation Solutions for Commercial Vehicles

Go here for our comprehensive portfolio of adaptation solutions. A preceding adaptation matrix should make it easier for you to find the correct adapter cable or control box for your vehicle.
→ p. 48 et seq.



Adaptation Solutions for Agricultural Machines

Go here to find our adaptation solutions for agricultural machines. → p. 62 et seq.

Question 6: Do you need additional accessories or active alarm systems?

Camera Accessories
e.g. shutter camera bracket, 24V



p. 38 et seq.

Monitor Accessories
e.g. heavy-duty monitor bracket



p. 46 et seq.

Additional Accessories for Camera Monitor Systems
e.g. digital wireless system



p. 70 et seq.

Active Alarm Systems
e.g. Turn Assist System AAS 1312



p. 74 et seq.

Do you have any further questions or would you like to receive an offer for your custom vision solution?

We are here for you! Call us or send us an email with your questions or concerns. At our various aftermarket locations, we have experts at hand who will be happy to assist you. We are looking forward to hearing from you.



Aftermarket Locations

Contact and service
→ p. 89 et seq.

Cameras and accessories

Camera Monitor Systems

CMOS cameras

CMOS camera



m

Dimensions	65 x 59 x 50 mm (W x H x D)
Operating voltage	10 - 36 V
Operating temperature	-40 °C to +85 °C
Aperture angle	70°/100°/120°
Shock resistance	50 G
IP rating	IP 69 K, dust-proof, withstands high-pressure cleaning
Connection type	MEKRA, IP 69 K
Video format	NTSC/PAL (analog)

ⓔ RoHS Ⓡ CE

Heated and extra hardened front glass

Made in Germany

ADR tested ✓

Item No.	Description	Aperture angle
PAL video format		
28.1301.008.099	CMOS camera 70° PAL	70°
28.1301.002.099	CMOS camera 100° PAL	100°
28.1301.004.099	CMOS camera 120° PAL	120°
28.1301.006.099	CMOS camera 100° PAL low dist.	100°
28.1301.175.099	CMOS camera 100° PAL with distance marker	100°
NTSC video format		
28.1301.007.099	CMOS camera 70° NTSC	70°
28.1301.001.099	CMOS camera 100° NTSC	100°
28.1301.003.099	CMOS camera 120° NTSC	120°
28.1301.005.099	CMOS camera 100° NTSC low dist.	100°
28.1301.176.099	CMOS camera 100° NTSC with distance marker	100°

CMOS camera accessories

Design bracket

Dimensions	125 x 102 x 73 mm (W x H x D)	Sleek and attractive design bracket
Orientation	Fully adjustable as needed	
Material	ABS plastic	



Item No.	Description
11.1301.018.099	Design bracket

CMOS camera accessories

Standard bracket

Dimensions	90 x 100 x 73 mm (W x H x D)	Can be combined with magnetic base (Item No. 20.5640.101)
Orientation	Fully adjustable as needed	
Material	ABS plastic	



Item No.	Description
11.1301.017.099	Standard bracket

Mounting bracket

Dimensions	87 x 70 x 64 mm (W x H x D)	Camera can be tilted 180° within the bracket and swiveled with the bracket Can be combined with magnetic base (Item No. 20.5640.101)
Orientation	Fully adjustable as needed	
Material	Stainless steel	

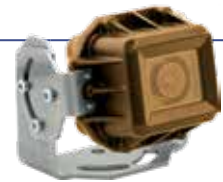

Compact bracket

Item No.	Description
11.1200.501.099	Mounting bracket

Mounting bracket with protective hood

Dimensions	87 x 74 x 70 mm (W x H x D)	Camera can be tilted 180° within the bracket and swiveled with the bracket The hood offers additional protection in tough work environments. Can be combined with magnetic base (Item No. 20.5640.101)
Orientation	Fully adjustable as needed	
Material	Stainless steel	



Compact bracket

Item No.	Description
11.1200.502.099	Mounting bracket with protective hood

Magnetic base

Dimensions	66 x 19 mm (Dia. x H)	Compatible with
Adhesive force	180 N	
Ideal for all flexible applications and where drilling holes is not possible		<ul style="list-style-type: none"> • Standard bracket (Item No. 11.1301.017.099) • Mounting bracket (Item No. 11.1200.501.099) • Mounting bracket with protective hood (Item No. 11.1200.502.099) • Standard bracket for spherical camera (Item No. 20.5620.601) • MCPA Mounting bracket with protective hood (Item No. 11.1307.027.099) • MCPA spherical bracket (Item No. 11.1307.028.099)



Item No.	Description
20.5640.101	Magnetic base

Cameras and Camera Accessories

Camera Monitor Systems

CMOS spherical cameras

CMOS spherical camera

Dimensions	55 x 49 mm (Dia. x D)
Operating voltage	10 - 36 V
Operating temperature	-40 °C to +85 °C
Aperture angle	100°/120°
Shock resistance	50 G
IP rating	IP 69 K, dust-proof, withstands high-pressure cleaning
Connection type	MEKRA, IP 69 K
Video format	NTSC/PAL (analog)

Heated and extra hardened front glass

Made in Germany

ADR tested 



m



Item No.	Description	Aperture angle
PAL video format		
28.1301.014.099	CMOS spherical camera 100° PAL	100°
28.1301.038.099	CMOS spherical camera 120° PAL	120°
NTSC video format		
28.1301.013.099	CMOS spherical camera 100° NTSC	100°
28.1301.039.099	CMOS spherical camera 120° NTSC	120°

Spherical camera accessories

Standard bracket for spherical camera

Dimensions	80 x 71 x 28 (W x H x D)	Can be combined with magnetic base (Item No. 20.5640.101)
Orientation	Fully adjustable as needed	
Material	ABS plastic	



Item No.	Description
20.5620.601	Standard bracket for spherical camera

Magnetic base

Dimensions	66 x 19 mm (Dia. x H)	Compatible with: <ul style="list-style-type: none">• Standard bracket (Item No. 11.1301.017.099)• Mounting bracket (Item No. 11.1200.501.099)• Mounting bracket with protective hood (Item No. 11.1200.502.099)• Standard bracket for spherical camera (Item No. 20.5620.601)• MCPA Mounting bracket with protective hood (Item No. 11.1307.027.099)• MCPA spherical bracket (Item No. 11.1307.028.099)
Adhesive force	180 N	

Ideal for all flexible applications and where drilling holes is not possible



Item No.	Description
20.5640.101	Magnetic base

Cameras and Camera Accessories

Camera Monitor Systems

Analog platform cameras (MCPA)

MEKRA Camera Platform Analog (MCPA)



m

Dimensions	36 x 36 x 45 mm (W x H x D)
Operating voltage	10 - 36 V
Operating temperature	-40 °C to +85 °C
Aperture angle	70°, 100° oder 120°
Shock resistance	50 G
IP rating	IP 69 K, dust-proof, withstands high-pressure cleaning
Connection type	MEKRA, IP 69 K
Video format	NTSC/PAL (analog)
Made in Germany	
ADR tested	✔

ⓔ RoHS Ⓢ FCC Ⓢ CE

Item No.	Description	Aperture angle
PAL color camera		
28.1307.001.099	MCPA 70° PAL	70°
28.1307.002.099	MCPA 100° PAL	100°
28.1307.010.099	MCPA 100° PAL low dist.	100°
28.1307.003.099	MCPA 120° PAL	120°
NTSC color camera		
28.1307.004.099	MCPA 70° NTSC	70°
28.1307.005.099	MCPA 100° NTSC	100°
28.1307.011.099	MCPA 100° NTSC low dist.	100°
28.1307.006.099	MCPA 120° NTSC	120°

Accessories for analog platform cameras

MCPA Mounting bracket with protective hood

Dimensions	54 x 58 x 59 mm (W x H x D)	Can be combined with magnetic base (Item No. 20.5640.101)
Material	Stainless steel	



Item No.	Description
11.1307.028.099	MCPA Mounting bracket with protective hood

MCPA spherical bracket

Dimensions	80 x 71 x 45 mm (W x H x D)	Can be combined with magnetic base (Item No. 20.5640.101)
Material	Plastic	



Item No.	Description
11.1307.027.099	MCPA spherical bracket

Magnetic base

Dimensions	66 x 19 mm (Dia. x H)
Adhesive force	180 N

Ideal for all flexible applications and where drilling holes is not possible

Compatible with:

- **Standard bracket** (Item No. 11.1301.017.099)
- **Mounting bracket** (Item No. 11.1200.501.099)
- **Mounting bracket with protective hood** (Item No. 11.1200.502.099)
- **Standard bracket for spherical camera** (Item No. 20.5620.601)
- **MCPA Mounting bracket with protective hood** (Item No. 11.1307.027.099)
- **MCPA spherical bracket** (Item No. 11.1307.028.099)



Item No.	Description
20.5640.101	Magnetic base

Cameras and Camera Accessories

Camera Monitor Systems

Accessories for analog platform cameras / shutter cameras

Shutter camera bracket, 24 V

Dimensions	113 x 97 x 107 mm (W x H x D)	Operating voltage	24 V
		Operating temp.	-40 °C to +85 °C



Item No.	Description
61.1307.014.099	Shutter camera bracket, 24 V

Y-adapter, driver's cab, AMP (m-f), 0.5 m

For activating the shutter via a switching signal, e.g. reverse gear



Item No.	Description
09.1307.017.099	Y-adapter, driver's cab, AMP (m-f), 0.5 m

Y-adapter, driver's cab, AMP (m-f), 3 m

For activating the shutter via a switching signal, e.g. reverse gear



Item No.	Description
09.1307.024.099	Y-adapter, driver's cab, AMP (m-f), 3 m

Y-adapter, driver's cab, AMP (m-f), 0.5 m

For activating the shutter via a switching signal, e.g. reverse gear



Item No.	Description
09.1307.019.099	Y-adapter, driver's cab MEKRA (m-f) 0.5 m

Y-adapter, camera (m-f), 0.5 m

For connecting the camera cable with the platform camera and shutter camera bracket



Item No.	Description
09.1307.021.099	Y-adapter, camera (m-f), 0.5 m

Consistently excellent vision is ensured by using the platform camera with a mounting bracket that is equipped with an automatic shutter (shutter camera bracket). It covers the lens while the vehicle is in motion to protect the lens from dirt and debris. As soon as the driver goes into reverse, the shutter opens and the driver is provided with the best possible view through the clean camera.

Shutter system / shutter camera configuration

Choose a Y-adapter based on the interface used in the vehicle:

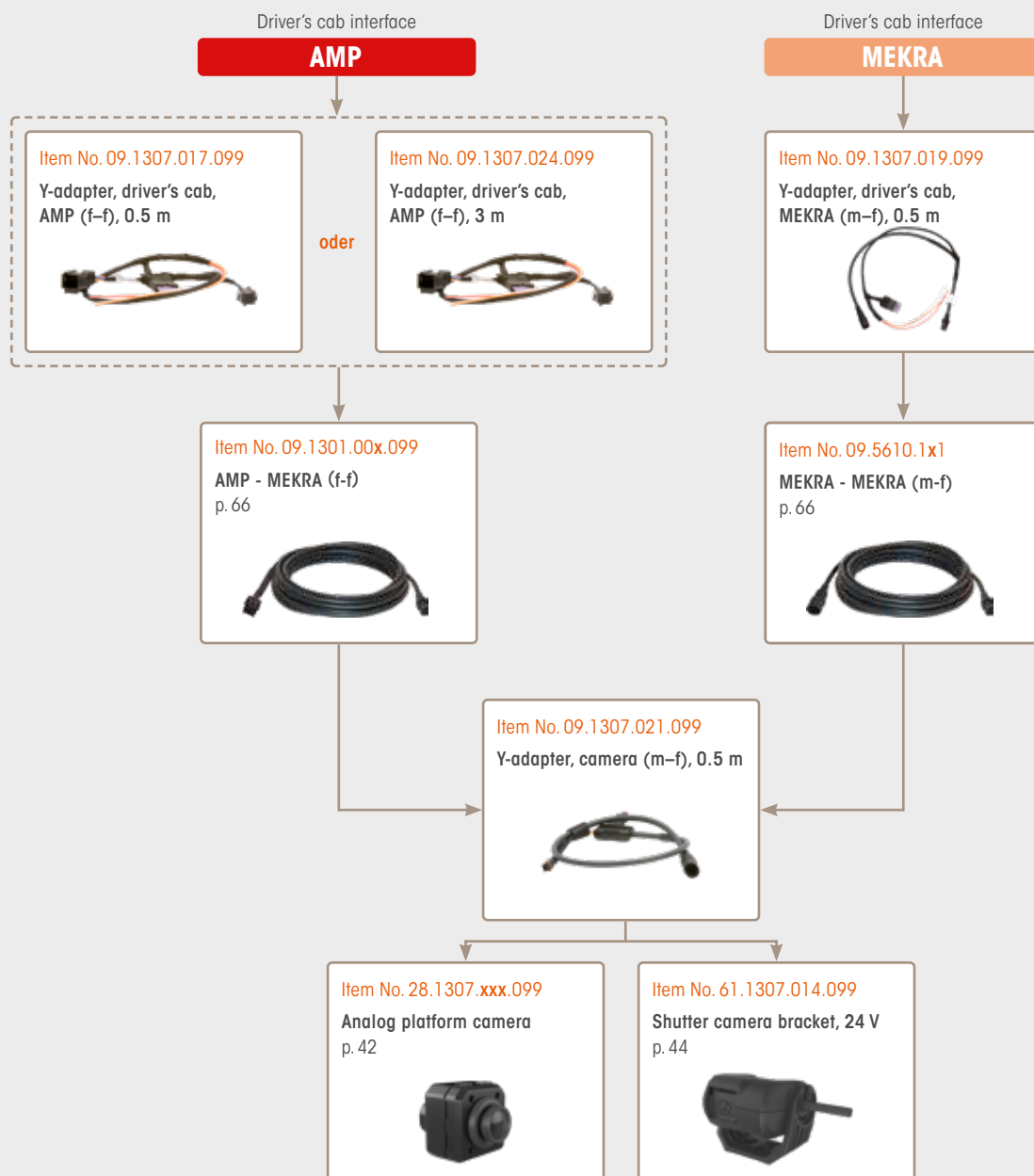

Monitors and Monitor Accessories

Camera Monitor Systems

Monitors

7" MEKRA LED Monitor



Abmessungen	190 x 120 x 44 mm (W x H x D)
Resolution	800 x 480 pixels
Operating voltage	9 - 36 V
Operating temp.	-30 °C to +85°C
Brightness	500 cd/m ²
Camera inputs	4
Contrast ratio	600:1

Ip rating	IP 65
Aspect ratio	16:9
Connection type	AMP
Video format	NTSC / PAL
Trailer detection integrated	
Incl. power cable and standard monitor bracket (item no. 20.5610.400)	

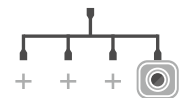

RoHS FC CE

Item No.	Description
24.1301.501.099	7" MEKRA LED Monitor

7" TFT-LCD Monitor



Dimensions	192 x 128 x 30 mm (W x H x D)
Resolution	800 x 480 pixels
Operating voltage	12 / 24 V
Operating temp.	-20 °C to +70 °C
Brightness	400 cd/m ²
Camera inputs	2
Contrast ratio	500:1

Aspect ratio	16:9
Connection type	MiniDIN
Video format	NTSC / PAL
AV ON/OFF	
Incl. power cable and standard monitor bracket (Item No. 20.5610.400)	



RoHS FC CE

Item No.	Description
24.1306.500.099	7" TFT-LCD Monitor

7" TFT-LCD Monitor Quad



Dimensions	197 x 125 x 32 mm (W x H x D)
Resolution	800 x 480 pixels
Operating voltage	12 / 24 V
Operating temp.	-25 °C to +75 °C
Brightness	500 cd/m ²
Camera inputs	4
Contrast ratio	400:1

Ip rating	IP 65
Aspect ratio	16:9
Connection type	MiniDIN
Video format	NTSC / PAL
AV ON/OFF	
Incl. power cable and standard monitor bracket (Item No. 20.5610.400)	

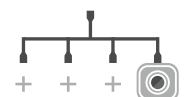

RoHS FC CE

Item No.	Description
61.1313.001.099	7" TFT-LCD Monitor Quad

Monitor accessories

Standard monitor bracket

Dimensions 100 x 97 x 74 mm
(W x H x D)



Item No.	Description
20.5610.400	Standard monitor bracket

Heavy-duty monitor bracket with mounting plate

Overall height up to 10 cm
Designed for installation on a smooth surface, see example in illustration **1**

Compatible with 7" TFT-LCD quad monitor (item no. 61.1313.001.099)



Special Item No.	Description
701015	Heavy-duty monitor bracket with mounting plate

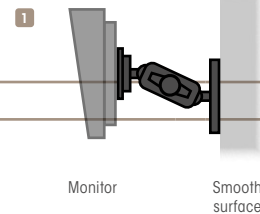

Heavy-duty monitor bracket with clamping bracket

Overall height up to 10 cm
Designed for installation on tubular bracket with 24–32 mm tube diameter, see example in illustration **2**

Compatible with 7" TFT-LCD quad monitor (item no. 61.1313.001.099)

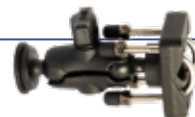

Special Item No.	Description
701018	Heavy-duty monitor bracket with clamping bracket

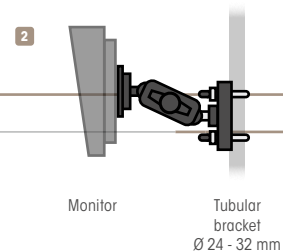

Control box trailer detection system

Automatic trailer detection for tractor-trailers

Easy integration of TFT-LCD monitors and connecting cables



Special Item No.	Description	Length
710002	Control box trailer detection system (m-f) 0.5 m	0.5 m

Adaptation Solutions for Existing Displays / Commercial Vehicles

Camera Monitor Systems

DAF

Adaption Matrix

Display: TNR 5" / model year: up to 2021					
Camera pre-fitting	Adaptation solution for 1 camera	Adaptation solution for 2 cameras	Adaptation solution for 3 cameras	Connector system	Video format
-	Control box 08.5600.502.003	Control box 08.5600.502.003	Control box 08.5600.502.003	AMP	PAL

Display: IVI / model year: up to 2022					
Camera pre-fitting	Adaptation solution for 1 camera	Adaptation solution for 2 cameras	Adaptation solution for 3 cameras	Connector system	Video format
06509	Adapter cable 941001	-	-	MEKRA	PAL

Adapter cable

DAF adapter

Adapter for connecting **one** Camera to a DAF IVI display with camera pre-fitting



Item No.	Description	Length
941001	DAF adapter	0,5 m

Control box

DAF control box

Control box incl. connecting cable for GPS system DAF, Scania 5" and MAN MMT1 without pre-fitting

For connecting **multiple** cameras
Integrated trailer detection



Item No.	Description	Length
08.5600.502.003	Control box for DAF, Scania and MAN MMT1 (m), 2 m	2 m

IVECO

Adaption Matrix

Display: IVECONNECT / HI-CONNECT					
Camera pre-fitting	Adaptation solution for 1 camera	Adaptation solution for 2 cameras	Adaptation solution for 3 cameras	Connector system	Video format
-	Adapter cable 1 09.1301.107.099	2x Adapter cable ¹⁾ 1 09.1301.107.099 or control box ²⁾ 2 08.5600.503.099	Control box 2 08.5600.503.099	Adapter cable: MEKRA Control box: AMP	PAL

For tractor trailers we recommend using control box 08.5600.503.099. It has an integrated trailer detection system.

Trailer detection: When a trailer is hooked up to the tractor, the trailer camera is displayed; when operating without a trailer, the tractor camera is displayed.

¹⁾ Using two adapter cables enables the driver to switch between camera images manually (e.g. rear view camera and dump box).

²⁾ Using the control box enables the driver to switch between camera images automatically (tractor and trailer).

Adapter cable

Iveco adapter

Adapter for connecting one camera to an Iveco GPS system



Item No.	Description	Length
1 09.1301.107.099	Iveco adapter (f), 4 m	4 m

Control box

Iveco control box

Control box incl. connecting cable for Iveco GPS system

For connecting **multiple** cameras
Integrated trailer detection



Item No.	Description	Length
2 08.5600.503.099	Control box for Iveco (m), 4 m	4 m

Adaptation Solutions for Existing Displays / Commercial Vehicles

Camera Monitor Systems

MAN TRUCK-DISPLAYS

Adaption Matrix

Display: MMT1 / model year: up to 2016					
Camera pre-fitting	Adaptation solution for 1 camera	Adaptation solution for 2 cameras	Adaptation solution for 3 cameras	Connector system	Video format
351 LZ	Adapter cable 1 09.1301.062.001	Control box 5 08.5600.504.003	Control box 5 08.5600.504.003	AMP	PAL

Display: MMT2 / model year: 2016 – 2020					
Camera pre-fitting	Adaptation solution for 1 camera	Adaptation solution for 2 cameras	Adaptation solution for 3 cameras	Connector system	Video format
351 ME	Adapter cable 1 09.1301.140.001	Control box 5 08.5600.505.003	Control box 5 08.5600.505.003	AMP	PAL
351 MF	Adapter cable 2 09.1301.140.001	2x Adapter cable ¹⁾ 2 09.1301.140.001	Control box 6 08.5600.505.003	AMP	PAL
		or control box ²⁾ 6 08.5600.505.003		AMP	PAL

Display: MMT3 / model year: from 2021					
Camera pre-fitting	Adaptation solution for 1 camera	Adaptation solution for 2 cameras	Adaptation solution for 3 cameras	Connector system	Video format
OP2D1	Adapter cable 3 09.1307.020.099	Control box 7 08.5600.506.099	Control box 7 08.5600.506.099	AMP	PAL
OP2D3	Adapter cable 3 09.1307.020.099	2x Adapter cable ¹⁾ 3 09.1307.020.099	Control box 7 08.5600.506.099	AMP	PAL
		or control box ²⁾ 7 08.5600.506.099		AMP	PAL
OPHIK	Adapter cable 4 09.1307.023.099	2x Adapter cable ¹⁾ 4 09.1307.023.099		MEKRA	PAL

For tractor trailers we recommend using control box 08.5600.50x.xxx. It has an integrated trailer detection system.

Trailer detection: If a trailer is hooked up to the tractor, the trailer camera is displayed, when operating without a trailer, the tractor camera is displayed.

¹⁾ Using two adapter cables enables the driver to switch between camera images manually (e.g. rear view camera and dump box).

²⁾ Using the control box enables the driver to switch between camera images automatically (tractor and trailer).

Adapter cable

MAN adapter



Adapter for connecting **one** camera to MAN GPS system with pre-fitting



Item No.	Description	Length
MMT1		
1 09.1301.062.001	MAN - 351 LZ (m), 0.3 m	0,3 m
MMT2		
2 09.1301.140.001	MAN - 351 ME, MF (m), 0.3 m	0,3 m
MMT3		
3 09.1307.020.099	MAN MMT3/ Scania 7 ^m Premium (m), 0.3 m	0,3 m
4 09.1307.023.099	MAN adapter - OPHIK (F), 1.5 m	1,5 m



Control boxes

MAN control box



Control box incl. connecting cables for MAN GPS system with camera pre-fitting

For connecting **multiple** cameras
Integrated trailer detection

ⓔ RoHS FC CE

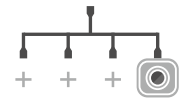

Item No.	Description	Length
MMT1		
5 08.5600.504.003	Control box for MAN 351 LZ (m), 0.5 m	0.5 m
MMT2		
6 08.5600.505.003	Control box for MAN 351 ME, MF (m), 0.5 m	0.5 m
MMT3		
7 08.5600.506.099	Control box MAN MMT3 / Scania 7 ^m Premium (m), 0.5 m	0.5 m



Adaptation Solutions for Existing Displays / Commercial Vehicles

Camera Monitor Systems

MAN TGE

Adaption Matrix

Model year: from 2017					
Camera pre-fitting	Adaptation solution for 1 camera	Adaptation solution for 2 cameras	Adaptation solution for 3 cameras	Connector system	Video format
632KM	Adapter cable 09.1307.003.000	–	–	AMP	NTSC

MAN TGE adapter cable

MAN TGE adapter

Adapter for connecting **one** camera to VW Crafter / MAN TGE with pre-fitting KA8 / 632KM

Note: Use only with NTSC camera



Item No.	Description	Length
09.1307.003.000	VW Crafter / MAN TGE with pre-fitting KA8 / 632KM (m) 0.5 m	0.5 m

MERCEDES-BENZ

Adaption Matrix

Camera pre-fitting	Adaptation solution for 1 camera	Adaptation solution for 2 cameras	Adaptation solution for 3 cameras	Connector system	Video format
J9J	Adapter cable 1 09.6000.001.000	Control box 4 08.5600.501.002	Control box 4 08.5600.501.002	Adapter cable: MEKRA Control box: AMP	NTSC
J9P	Adapter cable 2 09.1301.178.000	Adapter cable ¹⁾ 3 09.1301.179.000 or Adapter cable 2 09.1301.178.000 and control box ²⁾ 5 710019	Adapter cable 3 09.1301.179.000	Adapter cable: MEKRA Control box: AMP	PAL

For tractor trailers we recommend using control box 710019 or 08.5600.501.002. It has an integrated trailer detection system.

Trailer detection: If a trailer is hooked up to the tractor, the trailer camera is displayed, when operating without a trailer, the tractor camera is displayed.

¹⁾ Using adapter cable 09.1301.179.000 enables the driver to switch between camera images manually (e.g. rear view camera and dump box).

²⁾ Using the control box enables the driver to switch between camera images automatically (tractor and trailer).

Adapter cable

MB J9J - MEKRA

Adapter for connecting one camera to Mercedes-Benz with pre-fitting J9J



Item No.	Description	Length
1 09.6000.001.000	MB J9J - MEKRA (f), 0.3 m	0.3 m

MB J9P - 1x MEKRA

Adapter for connecting **one** camera to Mercedes-Benz with pre-fitting J9P

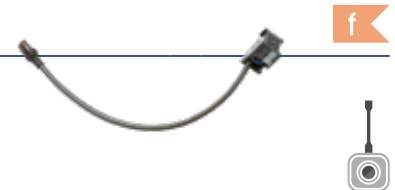

Item No.	Description	Length
2 09.1301.178.000	MB J9P - 1x MEKRA (f), 0.5 m	0.5 m

Adaptation Solutions for Existing Displays / Commercial Vehicles

Camera Monitor Systems

Adapter cable

MB J9P - 4x MEKRA (f)

Adapter for connecting up to **four** cameras to Mercedes-Benz with pre-fitting J9P

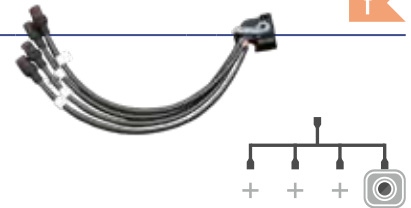

Item No.	Description	Length
3 09.1301.179.000	MB J9P - 4x MEKRA (f), 0.5 m	0.5 m

Control boxes

Control box for Mercedes J9J

Control box incl. connecting cable for Mercedes-Benz with pre-fitting J9J

For connecting **multiple** cameras
Integrated trailer detection

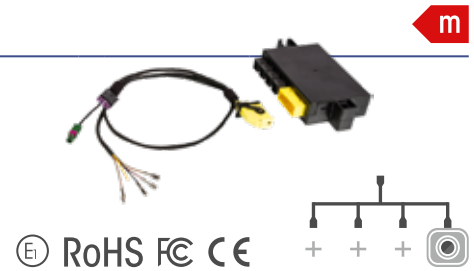

Item No.	Description	Length
4 08.5600.501.002	Control box for Mercedes J9J (m), 0.5 m	0.5 m

Control box with MEKRA outlet

Control box incl. connecting cable for Mercedes-Benz with pre-fitting J9P

For connecting **multiple** cameras
Integrated trailer detection

Can only be used in combination with the following adapters:

- MB J9P - 1x MEKRA (Item No. 09.1301.178.000)
- or
- MB J9P - 4x MEKRA (Item No. 09.1301.179.000)

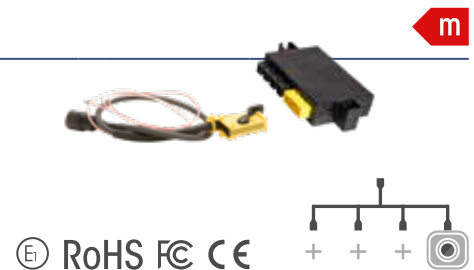

Special Item No.	Description	Length
5 710019	Control box with MEKRA outlet(m), 0.5 m	0.5 m

RENAULT

Adaption Matrix

Fahrzeug: T, T High, K und C 2.5					
Camera pre-fitting	Adaptation solution for 1 camera	Adaptation solution for 2 cameras	Adaptation solution for 3 cameras	Connector system	Video format
3YS02	Adapter cable 09.1301.108.099	2x Adapter cable 09.1301.108.099	3x Adapter cable 09.1301.108.099	MEKRA	PAL

Depending on the vehicle's model year and configuration, in some cases Renault adapter 7423315639 will also be required.

Adapter cables

Adapter für Renault

Adapter for connecting **one** camera to Renault with pre-fitting 3YS02



Item No.	Description	Length
09.1301.108.099	Volvo / Renault adapter with pre-fitting (f), 0.5 m	0.5 m

Adaptation Solutions for Existing Displays / Commercial Vehicles

Camera Monitor Systems

SCANIA

Adaption Matrix

Display: Premium Radio 5" / model year: up to 2015					
Camera pre-fitting	Adaptation solution for 1 camera	Adaptation solution for 2 cameras	Adaptation solution for 3 cameras	Connector system	Video format
–	Control box 2 08.5600.502.003	Control box 2 08.5600.502.003	Control box 2 08.5600.502.003	AMP	PAL

Display: Infotainment Premium 7" / model year: from 2016					
Camera pre-fitting	Adaptation solution for 1 camera	Adaptation solution for 2 cameras	Adaptation solution for 3 cameras	Connector system	Video format
–	Adapter cable 1 09.1307.020.099	2x Adapter cable ¹⁾ 1 09.1307.020.099	Control box 3 08.5600.506.099	AMP	PAL
		or control box ²⁾ 3 08.5600.506.099		AMP	PAL

For tractor trailers we recommend using control box 08.5600.50x.xxx. It has an integrated trailer detection system.

Trailer detection: If a trailer is hooked up to the tractor, the trailer camera is displayed, when operating without a trailer, the tractor camera is displayed.

¹⁾ Using two adapter cables enables the driver to switch between camera images manually (e.g. rear view camera and dump box).

²⁾ Using the control box enables the driver to switch between camera images automatically (e.g. For tractor trailers or vehicles with trailers).

Adapter cable

Scania Adapter



Adapter for connecting **one** camera to to Scania Infotainment Premium



Item No.	Description	Length
1 09.1307.020.099	MAN MMT3/ Scania 7" Premium (m), 0.3 m	0,3 m

Control boxes

Control boxes for Scania (m)



Control box incl. connecting cable for Scania Premium devices
 For connecting **multiple** cameras
 Integrated trailer detection



Ⓛ RoHS FC CE

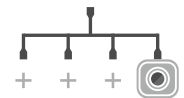

Item No.	Description	Length
2 08.5600.502.003	Control box for DAF, Scania and MAN MMT1 (m), 2 m	2 m
3 08.5600.506.099	Control box MAN MMT3 / Scania 7" Premium (m), 0.5 m	0.5 m

Adaptation Solutions for Existing Displays / Commercial Vehicles

Camera Monitor Systems

VOLVO

Adaption Matrix

Model year: up to 2020					
Camera pre-fitting	Adaptation solution for 1 camera	Adaptation solution for 2 cameras	Adaptation solution for 3 cameras	Connector system	Video format
BUPMON	Adapter cable 09.1301.108.099	2x Adapter cable 09.1301.108.099	3x Adapter cable 09.1301.108.099	MEKRA	PAL

Model year: from 2021					
Camera pre-fitting	Adaptation solution for 1 camera	Adaptation solution for 2 cameras	Adaptation solution for 3 cameras	Connector system	Video format
MCA-A	Adapter cable 09.1301.108.099	Adapter cable 09.1301.108.099		MEKRA	PAL
		and control box 710019		AMP	PAL

Adapter cable

Volvo adapter

Adapter for connecting **one** camera to Volvo with pre-fitting

IP 69 K connector (MEKRA-side)



Item No.	Description	Length
09.1301.108.099	Volvo / Renault adapter with pre-fitting (f), 0.5 m	0.5 m

Control box with MEKRA outlet

Control box incl. connecting cable for Volvo with pre-fitting MCA-A

For connecting **multiple** cameras

Integrated trailer detection

Can only be used in combination with the following adapter:

- Adapter Volvo / Renault with pre-fitting (Item No. 09.1301.108.099)

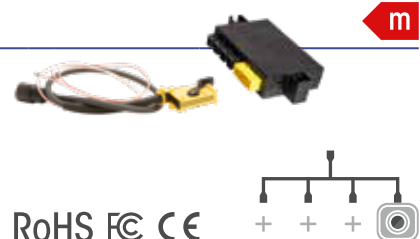

Special Item No.	Description	Length
710019	Control box with MEKRA outlet (m), 0.5 m	0.5 m

VOLKSWAGEN (VW)

Adaption Matrix

Model year: from 2017					
Camera pre-fitting	Adaptation solution for 1 camera	Adaptation solution for 2 cameras	Adaptation solution for 3 cameras	Connector system	Video format
KA8	Adapter cable 09.1307.003.000			AMP	NTSC

Adapter cable

VW Crafter adapter

Adapter for connecting **one** camera to VW Crafter / MAN TGE with pre-fitting KA8 / 632KM

Note: Use only with NTSC camera



Item No.	Description	Length
09.1307.003.000	VW Crafter / MAN TGE with pre-fitting KA8 / 632KM (m)	0.5 m

Adaptation Solutions for Existing Displays / Commercial Vehicles

Camera Monitor Systems

Astrata, FleetBoard and TomTom

Camera pre-fitting	Adaptation solution for 1 camera	Adaptation solution for 2 cameras	Adaptation solution for 3 cameras	Connector system	Video format
–	Adapter cable 1 900068	Control box 2 710010	Control box 2 710010	Adapter cable: MEKRA Control box: AMP	PAL

Adapter cable

Astrata, FleetBoard and TomTom adapter

Adapter for connecting **one** camera to GPS and telematics displays



Special Item No.	Description	Length
1 900068	Adapter for Astrata, FleetBoard and TomTom – MEKRA (f), 2 m	2 m

Control box

Astrata, FleetBoard and TomTom control box

Control box incl. connecting cable for GPS and telematics devices

For connecting **multiple** cameras

Integrated trailer detection



Special Item No.	Description	Length
2 710010	Control box for Astrata, FleetBoard and TomTom (m), 2,5 m	2,5 m

Displays with cinch interface

Camera pre-fitting	Adaptation solution for 1 camera	Adaptation solution for 2 cameras	Adaptation solution for 3 cameras	Connector system	Video format
-	Adapter cable 1 900010	Control box 2 710013	Control box 2 710013	Adapter cable: MEKRA Control box: AMP	PAL

Adapter cable

Adapter for displays with cinch interface

Adapter for connecting **one** camera to GPS and telematics displays with cinch interface



Special Item No.	Description	Length
1 900010	Cinch adapter - MEKRA (f), 2.5 m	2.5 m

Control box

Control box for displays with cinch interface

Control box incl. connecting cable for GPS and telematics displays with cinch interface

For connecting **multiple** cameras
Integrated trailer detection



Special Item No.	Description	Length
2 710013	Control box for cinch interface (m), 2.5 m	2.5 m

Adaptation Solutions for Existing Displays / Agricultural Machines

Camera Monitor Systems

CNH

Adapter cable

New Holland adapter

Adapter cable for connecting **one** camera



Special Item No.	Description	Length
900011	New Holland - MEKRA (f) 0.5 m	0.5 m

Case adapter

Adapter cable for connecting **one** camera, incl. power supply



Special Item No.	Description	Length
900022	Case BNC - MEKRA (f), 0.5 m	0.5 m

FENDT

Adapter cable

Fendt adapter

Adapter cable for connecting **one** camera
M12 circular connector, 5-pin



Special Item No.	Description	Length
900013	Fendt - MEKRA (f) 3 m	3 m
900016	Fendt - MEKRA (f) 0.5 m	0.5 m

Adaptation Solutions for Existing Displays / Agricultural Machines

Camera Monitor Systems

JOHN DEERE

Adapter cable

John Deere 6R Command Center adapter

Adapter cable for connecting **one** camera to series 6R



Special Item No.	Description	Length
900006	John Deere Command Center - MEKRA (f) 5 m	5 m

John Deere 6R Command Center 4600 adapter

Adapter cable for connecting up to **two** cameras to series 6R



Special Item No.	Description	Length
900018	John Deere Command Center 4600 - 2x MEKRA (f) 3 m	3 m

John Deere Command Center 7R/ 8R/ 9R adapter

Adapter cable for connecting **one** camera to series 7R, 8R, and 9R



Special Item No.	Description	Length
900037	John Deere 7R / 8 R / 9R - MEKRA (f) 0.5 m	0.5 m

Adapter cable

Isobus Terminal adapter



Adapter cable for connecting **one** camera to an Isobus Terminal

M12 circular connector, 8-pin



Special Item No.	Description	Length
900036	Isobus Terminal - MEKRA (f) 0.5 m	0.5 m

Müller Elektronik Terminal adapter



Adapter cable for connecting **one** camera to a Müller touch display

M12 circular connector, 5-pin



Special Item No.	Description	Length
900040	Müller Elektronik - MEKRA (f) 0.5 m	0.5 m

Cables and Connections

Camera Monitor Systems

CMOS camera cables

MiniDIN - MEKRA (m-f)

For directly connecting **one** MEKRA CMOS camera to the monitors 24.1306.500.099 and 61.1313.001.099

UV resistant
Oil and gasoline resistant
IP rating IP 69 K



Item No.	Description	Length
09.5610.352	MiniDIN - MEKRA (m-f) 0.5 m	0.5 m
09.1201.007.099	MiniDIN - MEKRA (m-f) 5 m	5 m
09.1201.006.099	MiniDIN - MEKRA (m-f) 11 m	11 m
09.1201.008.099	MiniDIN - MEKRA (m-f) 16 m	16 m
09.1201.009.099	MiniDIN - MEKRA (m-f) 21 m	21 m

AMP - MEKRA (f-f)

For directly connecting **one** MEKRA CMOS camera to the control boxes as well as to adapters with AMP connector systems

ADR tested ✓
UV resistant
Oil and gasoline resistant
IP rating IP 69 K



Item No.	Description	Length
09.5610.360	AMP - MEKRA (f-f) 0.5 m	0.5 m
09.1301.003.099	AMP - MEKRA (f-f) 5 m	5 m
09.1301.004.099	AMP - MEKRA (f-f) 11 m	11 m
09.1301.005.099	AMP - MEKRA (f-f) 16 m	16 m
09.1301.006.099	AMP - MEKRA (f-f) 21 m	21 m

Multi cable MEKRA - MEKRA (m-f)

Compatible with adapters for MEKRA connector system and/or for use as extension cable

ADR tested ✓
UV resistant
Oil and gasoline resistant
IP rating IP 69 K



Item No.	Description	Length
09.5610.111	Multi cable MEKRA - MEKRA (m-f) 5 m	5 m
09.5610.121	Multi cable MEKRA - MEKRA (m-f) 11 m	11 m
09.5610.131	Multi cable MEKRA - MEKRA (m-f) 16 m	16 m
09.5610.141	Multi cable MEKRA - MEKRA (m-f) 21 m	21 m

Cables for analog platform cameras

MiniDIN - MEKRA (m-f)

For directly connecting **one** analog platform camera to the monitors
24.1306.500.099 and 61.1313.001.099

UV resistant
Oil and gasoline resistant
IP rating IP 69 K



Item No.	Description	Length
09.5610.352	MiniDIN - MEKRA (m-f) 0.5 m	0.5 m
09.1201.007.099	MiniDIN - MEKRA (m-f) 5 m	5 m
09.1201.006.099	MiniDIN - MEKRA (m-f) 11 m	11 m
09.1201.008.099	MiniDIN - MEKRA (m-f) 16 m	16 m
09.1201.009.099	MiniDIN - MEKRA (m-f) 21 m	21 m

AMP - MEKRA (f-f) für MCPA

For directly connecting **one** analog platform camera to the control boxes as well as to adapters with AMP connector system

ADR tested ✓
UV resistant
Oil and gasoline resistant
IP rating IP 69 K



Item No.	Description	Length
09.1307.008.099	AMP - MEKRA (f-f) für MCPA 5 m	5 m
09.1307.007.099	AMP - MEKRA (f-f) für MCPA 11 m	11 m
09.1307.006.099	AMP - MEKRA (f-f) für MCPA 16 m	16 m
09.1307.005.099	AMP - MEKRA (f-f) für MCPA 21 m	21 m

Multi cable MEKRA - MEKRA (m-f) für MCPA

Compatible with adapters for MEKRA connector system and/or for use as extension cable

ADR tested ✓
UV resistant
Oil and gasoline resistant
IP rating IP 69 K



Item No.	Description	Length
09.1307.014.099	Multi cable MEKRA - MEKRA (m-f) für MCPA 0.5 m	0.5 m
09.1307.013.099	Multi cable MEKRA - MEKRA (m-f) für MCPA 5 m	5 m
09.1307.012.099	Multi cable MEKRA - MEKRA (m-f) für MCPA 11 m	11 m
09.1307.011.099	Multi cable MEKRA - MEKRA (m-f) für MCPA 16 m	16 m
09.1307.010.099	Multi cable MEKRA - MEKRA (m-f) für MCPA 21 m	21 m

Cables and Connections

Camera Monitor Systems

Trailer connecting cables for 1 camera

MEKRA - ABS 7-pin (m-m)



Connecting socket for tractors
For connecting **one** MEKRA camera
to trailer or semi-trailer

ADR tested
UV resistant
Oil and gasoline resistant
IP rating IP 69 K



Item No.	Description	Length
09.5610.310	MEKRA - ABS 7-pin (m-m) 0.5 m	0.5 m

ABS 7-pin - MEKRA (m-f)



Connecting socket for trailers
or semi-trailers
For connecting **one** MEKRA camera
to trailer or semi-trailer

ADR tested
UV resistant
Oil and gasoline resistant
IP rating IP 69 K



Item No.	Description	Length
09.5610.320	ABS 7-pin - MEKRA (m-f) 0.5 m	0.5 m

ABS 7-pin spiral cable (f-f)



Spiral cable for flexible connections between
tractor and trailer or semi-trailer
For connecting **one** MEKRA camera
to trailer or semi-trailer

ADR tested
UV resistant
Oil and gasoline resistant
IP rating IP 69 K



Item No.	Description	Length
09.5610.225	ABS spiral cable 7-pin (f-f), 3 m	3 m

ABS 7-pin - MEKRA (f-f)



Cable for trailers
For connecting one MEKRA camera
to trailer

ADR tested
UV resistant
Oil and gasoline resistant
IP rating IP 69 K



with grommet



Item No.	Description	Length
09.1201.012.099	ABS 7-pin - MEKRA (f-f) 16 m	16 m

Trailer connecting cables for 2 cameras

2x MEKRA - ABS 7-pin (m-m)

Connecting socket for trailers
For connecting **two** MEKRA cameras to trailer or semi-trailer

UV resistant
Oil and gasoline resistant



Special Item No.	Description	Length
917502	2x MEKRA - ABS 7-pin (m-m) 0.5 m	0.5 m

ABS 7-pin - 2x MEKRA (m-f)

Connecting socket for trailers
For connecting **two** MEKRA cameras to trailer or semi-trailer

UV resistant
Oil and gasoline resistant



Special Item No.	Description	Length
971502	ABS 7-pin - 2x MEKRA (m-f) 0.5 m	0.5 m

ABS 7-pin shielded spiral cable (f-f)

Spiral cable for flexible connections between and trailer or semi-trailer
For connecting **two** MEKRA cameras to trailers or semi-trailers

UV resistant
Oil and gasoline resistant

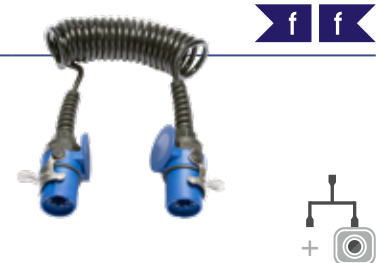

Special Item No.	Description	Length
977203	ABS spiral cable 7-pin shielded (f-f), 3 m	3 m

ABS 7-pin - 2x MEKRA (f-f)

Cable for trailers
For connecting two MEKRA cameras resistant to trailer

UV resistant
Oil and gasoline resistant



Special Item No.	Description	Length
971203	ABS 7-pin - 2x MEKRA (f-f) 3 m	3 m

Camera Monitor System Accessories

Camera Monitor Systems

Accessories for connections

ABS parking socket

Parking socket for protecting the spiral or trailer cable when disconnected



Item No.	Description
08.5610.110	ABS parking socket

Repair cables

MEKRA - open end

Repair cable incl. shrink grommet for repair work or individual cable configurations

IP rating IP 69 K (MEKRA-side)



Item No.	Description	Length
09.5610.050	MEKRA (m) - open end 0.5 m	0.5 m
09.5610.051	MEKRA (f) - open end 0.5 m	0.5 m

Adapter cable

MiniDIN - AMP (m-m)

Adapter for connecting existing AMD direct connecting to monitors with MiniDin connector

Compatible with the following monitors:

- 7" TFT-LCD monitor (Item No. 24.1306.500.099)
- 7" TFT-LCD quad monitor (Item No. 61.1313.001.099)



Special Item No.	Description	Length
932001	MiniDIN - AMP (m-m) 0.5 m	0.5 m

Adapter cables for 3rd party camera systems

MiniDIN HD - MEKRA (m-f)



Adapter for connecting **one** MEKRA camera to existing MiniDIN HD cables

IP rating IP 69 K (MEKRA-side)



Item No.	Description	Length
09.1301.124.099	MiniDIN HD - MEKRA (m-f) 0.5 m	0.5 m

Binder - MEKRA (m-f)



Adapter for connecting **one** MEKRA camera to existing M16 cables

IP rating IP 69 K (MEKRA-side)



Item No.	Description	Length
09.1301.069.099	Binder - MEKRA, fest gespiegelt (m-f) 0.5 m	0.5 m

Camera Monitor System Accessories

Camera Monitor Systems

Wireless system

Digital wireless system

Dimensions	65 x 65 x 33 mm (W x H x D)
Operating voltage	12 / 24 V
Operating temperature	-40 °C to + 85 °C
Frame rate	Up to 30 fps at 720 x 480 (NTSC)
Radio frequency	2.408 - 2.468 GHz
Range	200 m (open terrain)
IP rating	IP 69 K
Transmission rate	4 Mbps maximum

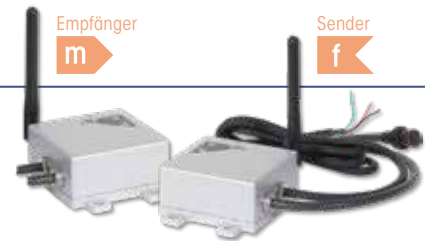

RoHS FC CE

Item No.	Description
23.1305.004.099	Wireless receiver
23.1305.005.099	Wireless transmitter

**Electromagnetic interference (EMI) can cause disruptions during the operation of the wireless system.
This does not constitute grounds for complaint.**

There are scenarios in which a wired video connection is not an option. This is where MEKRA Lang's digital wireless system comes in.

Whether on tower cranes, large telescopic handlers, or in any situation where moving machine parts prevent the use of cables, the digital wireless system can be used for instantaneous image transmission, showing processes performed in both large and small facilities.

For example, the fill state of a crushing plant can be transmitted to a supply vehicle.

Our wireless system provides optimum image transmission where a direct cable connection is not possible. Both the transmitter and the receiver feature a very rugged design and support 12V as well as 24V on-board power supply systems. Image transmission is interference-free and performed in real time (latency of about 100 ms).

To ensure a secure connection, transmitter and receiver have to be paired. Generally, this happens automatically but it can also be achieved manually, if needed.

Transmitter/receiver components:

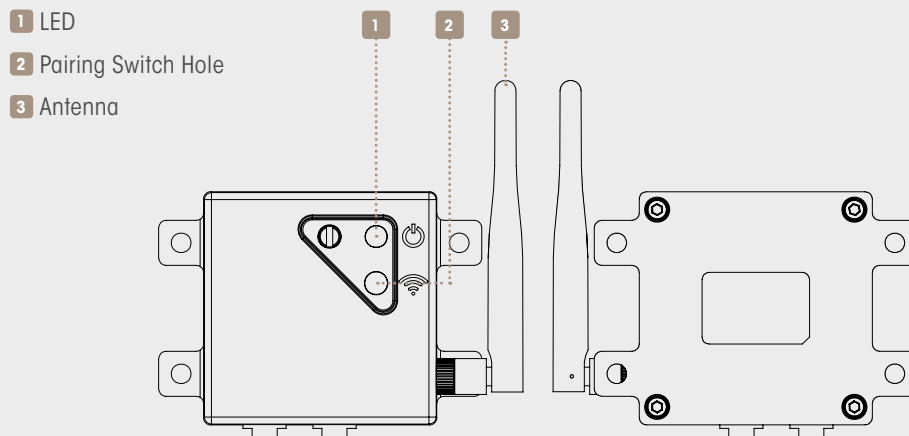

Example of a system set-up.



Turn Assist System AAS 1312 and Accessories

Active alarm systems

Kits

Turn Assist System AAS 1312 (with ABE)



Sensor **1**

Dimensions 124 x 103 x 33 mm
(W x H x D)

Operating voltage 9 - 33 V

Operating temp. -40 °C to +85 °C

Frequency range 24 GHz

IP rating IP 69 K

Shock resistance 25 G

Display (GPS **2** / CAN **3**)

Dimensions 50 x 27 mm (Dia. x D)

Operating temp. -40 °C to +85 °C

IP rating IP 67

Shock resistance 10 G

Housing ABS plastic, black

Power supply via radar sensor

RoHS FC CE

Item No.	Description	Components
GPS		
61.1312.002.099	Turn Assist System AAS 1312, GPS version (LHD)	1 2 4 5 6
CAN		
61.1312.001.099	Turn Assist System AAS 1312, CAN version (LHD)	1 3 5 6

Spare parts

Item No.	Description	Compatible with
08.1312.001.099	Sensor 3,4 m AAS (LHD) 1	
24.1312.001.099	GPS display (G2000) (LHD) 2	61.1312.002.099 (Turn Assist System, GPS version)
24.1312.002.099	CAN display (D2002) (LHD) 3	61.1312.001.099 (Turn Assist System, CAN version)
23.1312.001.099	GPS antenna 4	61.1312.002.099 (Turn Assist System, GPS version)
09.1312.001.099	SD cable kit 7.6 m AAS 5	Length 7.6 m
09.1312.002.099	SD cable kit 1 m / RCA 3 m 6	Length 1 m / 3 m

1



Sensor 3,4 m
AAS

2



GPS display
(G2000)

3



CAN display
(D2002)

4



GPS antenna
AAS

5



SD cable kit 7.6 m
AAS

6



SD cable kit 1 m / RCA
3 m

Radars sensor mounting brackets

Radars sensor mounting bracket, adjustable

Dimensions 220 x 120 x 50 mm (W x H x D)
Material Stainless steel

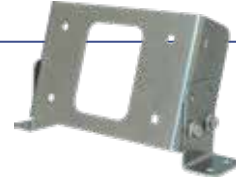

Special Item No.	Description
820170	Radars sensor mounting bracket, adjustable

Radars sensor mounting bracket, rigid

Dimensions 130 x 105 x 50 mm (W x H x D)
Material Stainless steel

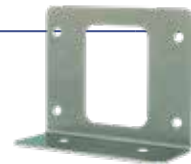

Special Item No.	Description
820190	Radars sensor mounting bracket, rigid

Extension cables

Chassis extension cable

Extension between:
 • Sensor and SD cable kit 7.6 m, AAS (Item No. 09.1312.001.099)



Item No.	Description	Length
09.1312.005.099	Chassis extension cable	6 m

Driver's cab extension cable

Extension between:
 • Display and SD cable kit 1 m, / RCA 3 m (Item No. 09.1312.002.099)
 or
 • SD cable kit 7.6 m, AAS (Item No. 09.1312.001.099) und
 SD cable kit 1 m, / RCA 3 m (Item No. 091312002099)



Item No.	Description	Length
09.1312.004.099	Driver's cab extension cable	4,5 m

Turn Assist System AAS 1314 and Accessories

Active alarm systems

Kits

Turn Assist System AAS 1314 (with ABE)

Sensor **1**

Dimensions 115 x 9,5 x 41 mm
(W x H x D)

Operating voltage 8 - 32 V

Operating temp. -40 °C to +85 °C

Frequency range 76-77 GHz

IP rating IP 69 K

Shock resistance 50 G

Display **2**

Dimensions 130 x 63 x 43 mm
(W x H x D)

Operating voltage 8 - 32 V

Operating temp. -40 °C to +85 °C

IP rating IP 32



RoHS FC CE

Item No.	Description	Components
AAS		
61.1314.001.099	Turn Assist System AAS 1314	1 2 3 4 7 8
Sensor		
12.1314.001.099	Cover sensor	5

Spare parts

Item No.	Description
08.1314.001.099	Sensor AAS 1314 1
24.1314.001.099	Display AAS 1314 2
23.1314.001.099	IMU 3
09.1314.001.099	Cable kit AAS 1314 8 m 4
12.1314.001.099	Cover sensor 5
09.1314.002.099	Extension cord 3 m 6
11.1314.001.099	Bracket display 7
11.1314.002.099	Bracket IMU 8



Sensor AAS



Display



IMU



Cable kit 8 m



Cover sensor



Extension cord 3 m



Bracket Display



Bracket IMU

Flexible, reliable and easy to install

The AAS 1314 turning assistance system works with an intelligent radar sensor and meets the latest guidelines for turning assistants according to UN **ECE R151**. This object detection system alerts the driver of medium-sized and heavy-duty commercial vehicles (> 3.5 t) to weaker road users who are in the danger zone next to the vehicle.

Easy installation in the generously sized standard mounting area allows for quick installation in almost any vehicle with a wheelbase between 3.5 m and 5 m. Once the power supply has been connected, the system is ready for use without the need for additional calibration.

If the installation space shown below is left or if the wheelbase of the vehicle deviates, the sensor must be adjusted. We will be happy to advise you on the various options for customization.

Standard Grow Area

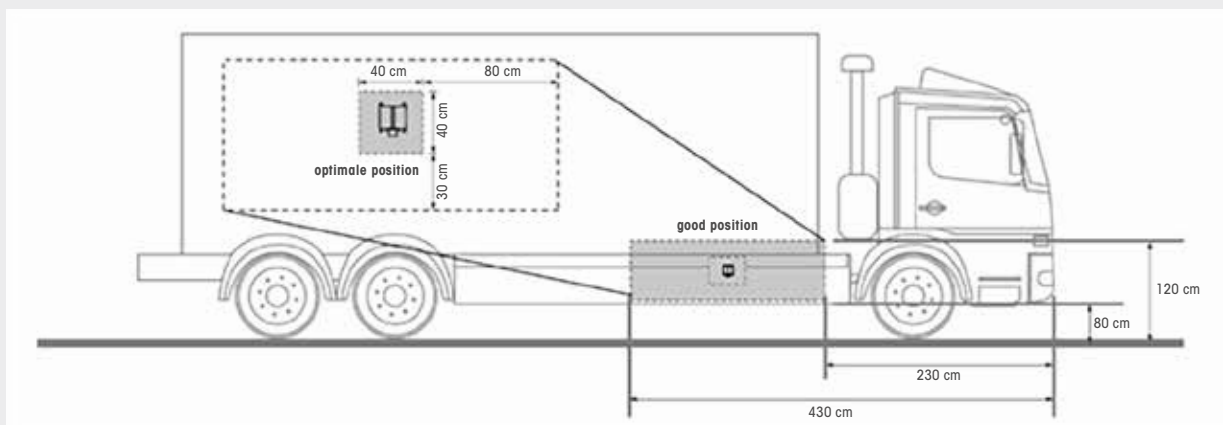



Appendix

Cross-reference-tables

MEKRAtronic – MEKRA Cross-reference-table / Product Overview	80 – 83
OE Numbers – MEKRA Cross-reference-table	84 – 86
ALBACH	84
BOSCH REXROTH	84
DOOSAN	84
HORSCH	84
HSM	84
KOMATSU	84
LIEBHERR MISCHECHNIK	84
LINDE/KLON	84
MAN	85
MERCEDES-BENZ	86
PONSSE	86
TRIOLET	86
Notes	87
Funding Programs	88
Aftermarket Locations	89
General Terms and Conditions	90 – 91

All vehicle manufacturers' reference numbers, mentioned in the catalog, as well as their brand names are only for identification purposes.

MEKRAtronic – MEKRA Cross-reference-table / Product Overview

Cross-reference-tables

Camera Monitor Systems

Cameras

Description	MEKRAtronic	MEKRA Lang	p.
CMOS camera			
70° PAL	101070	28.1301.008.099	38
70° NTSC	101072	28.1301.007.099	38
100° PAL	101100	28.1301.002.099	38
100° NTSC	101102	28.1301.001.099	38
120° PAL	101120	28.1301.004.099	38
120° NTSC	101122	28.1301.003.099	38
100° PAL low distortion	102100	28.1301.006.099	38
100° NTSC low distortion	102102	28.1301.005.099	38
100° PAL with distance marker	102200	28.1301.175.099	38
100° NTSC with distance marker	102202	28.1301.176.099	38
CMOS spherical camera			
100° PAL	103100	28.1301.014.099	40
100° NTSC	103102	28.1301.013.099	40
120° PAL	103120	28.1301.038.099	40
120° NTSC	103122	28.1301.039.099	40
Analog platform camera (MCPA)			
70° PAL direct	105070	28.1307.001.099	42
70° NTSC direct	105072	28.1307.004.099	42
100° PAL direct	105100	28.1307.002.099	42
100° PAL direct low distortion	105101	28.1307.010.099	42
100° NTSC direct	105102	28.1307.005.099	42
100° NTSC direct low distortion	105104	28.1307.011.099	42
120° PAL direct	105120	28.1307.003.099	42
120° NTSC direct	105122	28.1307.006.099	42

Camera accessories

Description	MEKRAtronic	MEKRA Lang	p.
For CMOS camera			
Design bracket	701002	11.1301.018.099	38
Mounting bracket	701003	11.1200.501.099	39
Mounting bracket with protective hood	701004	11.1200.502.099	39
Standard bracket	701021	11.1301.017.099	39
Magnetic base	701005	20.5640.101	39
For CMOS spherical camera			
Standard bracket for spherical camera	703001	20.5620.601	41
Magnetic base	701005	20.5640.101	41
For analog platform camera (MCPA)			
MCPA Mounting bracket with protective hood	701023	11.1307.028.099	43
MCPA spherical bracket	701024	11.1307.027.099	43
Magnetic base	701005	20.5640.101	43
For analog platform camera / shutter camera			
Shutter camera bracket, 24 V	–	61.1307.014.099	44
Y-adapter, driver's cab AMP (m-f) 0.5 m	933501	09.1307.017.099	44
Y-adapter, driver's cab AMP (m-f) 3 m	–	09.1307.024.099	44
Y-adapter, driver's cab MEKRA (m-f) 0.5 m	911001	09.1307.019.099	44
Y-Adapter Kamera (m-f) 0.5 m	–	09.1307.021.099	44

Monitors

Description	MEKRAtronic	MEKRA Lang	p.
TFT-LCD Monitor			
7" MEKRA LED Monitor	507205	24.1301.501.099	46
7" TFT-LCD monitor	507202	24.1306.500.099	46
7" TFT-LCD quad monitor	527403	61.1313.001.099	46

Monitor accessories

Description	MEKRAtronic	MEKRA Lang	p.
Control box trailer detection system			
Control box trailer detection system (m-f)	710002	710002	46
Monitor bracket			
Standard monitor bracket	20.5610.400	20.5610.400	47
Heavy-duty monitor bracket with mounting plate	701015	701015	47
Heavy-duty monitor bracket with clamping bracket	701018	701018	47

Camera Monitor Systems

Adaptation solutions for existing displays / commercial vehicles

Description	MEKRAtronic	MEKRA Lang	p.
DAF			
Control box for DAF, Scania and MAN MMT1 (m), 2 m	710006	08.5600.502.003	48
Adapter cable	941001	941001	48
IVECO			
Control box for Iveco (m), 4 m	710008	08.5600.503.099	49
Iveco adapter (f), 4 m	900034	09.1301.107.099	49
MAN TRUCK DISPLAYS			
Control box for MAN 351 LZ (m), 0.5 m	710009	08.5600.504.003	51
Control box for MAN 351 ME, MF (m), 0.5 m	710015	08.5600.505.003	51
Control box for MAN MMT3 / Scania 7" Premium (m), 0.5 m	710017	08.5600.506.099	51
MAN adapter - 351 LZ (m), 0.3 m	900033	09.1301.062.001	51
MAN adapter - 351 ME, MF (m), 0.3 m	900075	09.1301.140.001	51
MAN MMT3/Scania 7" Premium (m), 0.3 m	900076	09.1307.020.099	51
MAN adapter - OPHIK (f), 1.5 m	900077	09.1307.023.099	51
MAN TGE			
VW Crafter / MAN TGE with pre-fitting KA8 / 632KM (m), 0.5 m	900096	09.1307.003.000	52
MERCEDES-BENZ			
Control box for Mercedes J9J (m), 0.5 m	710007	08.5600.501.002	54
Control box with MEKRA outlet (m), 0.5 m	710019	710019	54
MB J9J - MEKRA (f) 0.3 m	900012	09.6000.001.000	53
MB J9P - 1x MEKRA (f) 0.5 m	900101	09.1301.178.000	53
MB J9P - 4x MEKRA (f) 0.5 m	900104	09.1301.179.000	54
RENAULT			
Volvo / Renault adapter with pre-fitting (f), 0.5 m	900035	09.1301.108.099	55
SCANIA			
Control box for DAF, Scania 5" and MAN MMT1 (m), 2 m	710006	08.5600.502.003	57
Control box MAN MMT3 / Scania 7" Premium (m), 0.5 m	710014	08.5600.506.099	57
MAN MMT3 / Scania 7" Premium (m), 0.3 m	900076	09.1307.020.099	57

Adaptation solutions for existing displays / commercial vehicles

Description	MEKRAtronic	MEKRA Lang	p.
VOLVO			
Volvo / Renault adapter with pre-fitting(f), 0.5 m	900035	09.1301.108.099	58
Control box with MEKRA outlet (m), 0.5 m	710019	710019	58
VOLKSWAGEN (VW)			
VW Crafter / MAN TGE with pre-fitting KA8 / 632KM (m), 0.5 m	900096	09.1307.003.000	59
Astrata, FleetBoard and TomTom			
Control box for Astrata, FleetBoard and TomTom (m), 2.5 m	710010	710010	60
Adapter for Astrata, FleetBoard and TomTom – MEKRA (f), 2 m	900068	900068	60
Displays with cinch interface			
Control box for cinch interface (m), 2.5 m	710013	710013	61
Cinch adapter - MEKRA (f), 2.5 m	900010	900010	61

Adaptation solutions for existing displays / agricultural machines

Description	MEKRAtronic	MEKRA Lang	p.
CNH			
New Holland - MEKRA (f) 0.5 m	900011	900011	62
Case BNC - MEKRA (f) 0.5 m	900022	900022	62
FENDT			
Fendt - MEKRA (f) 3 m	900013	900013	63
Fendt - MEKRA (f) 0.5 m	900016	900016	63
JOHN DEERE			
John Deere Command Center - MEKRA (f), 5 m	900006	900006	64
John Deere Command Center - 2x MEKRA (f), 3 m	900018	900018	64
John Deere 7R / 8 R / 9R - MEKRA (f), 0.5 m	900037	900037	64
Isobus / Müller Elektronik			
Isobus Terminal - MEKRA (f), 0.5 m	900036	900036	65
Müller Elektronik - MEKRA (f), 0.5 m	900040	900040	65

MEKRAtronic – MEKRA Cross-reference-table / Product Overview

Cross-reference-tables

Camera Monitor Systems

Cables

Description	MEKRAtronic	MEKRA Lang	P.
MiniDIN - MEKRA (m-f)			
0.5 m	921500	09.5610.352	66 67
5 m	921005	09.1201.007.099	66 67
11 m	921011	09.1201.006.099	66 67
16 m	921016	09.1201.008.099	66 67
21 m	921021	09.1201.009.099	66 67
AMP - MEKRA (f-f)			
0.5 m	900001	09.5610.360	66
5 m	931005	09.1301.003.099	66
11 m	931011	09.1301.004.099	66
16 m	931016	09.1301.005.099	66
21 m	931021	09.1301.006.099	66
Multi cables MEKRA - MEKRA (m-f)			
5 m	911005	09.5610.111	66
11 m	911011	09.5610.121	66
16 m	911016	09.5610.131	66
21 m	911021	09.5610.141	66
AMP - MEKRA (f-f) for MCPA			
5 m	931205	09.1307.008.099	67
11 m	931211	09.1307.007.099	67
16 m	931216	09.1307.006.099	67
21 m	931221	09.1307.005.099	67
Multi cables MEKRA - MEKRA (m-f) for MCPA			
0.5 m	911200	09.1307.014.099	67
5 m	911205	09.1307.013.099	67
11 m	911211	09.1307.012.099	67
16 m	911216	09.1307.011.099	67
21 m	911221	09.1307.010.099	67

Connecting cable

Description	MEKRAtronic	MEKRA Lang	P.
Trailer connecting cables for 1 camera			
MEKRA - ABS 7-pin (m-m) 0.5 m	917500	09.5610.310	68
ABS 7-pin - MEKRA (m-f) 0.5 m	971500	09.5610.320	68
ABS spiral cable 7-pin (f-f), 3 m	977003	09.5610.225	68
ABS 7-pin - MEKRA (f-f), 16 m	971016	09.1201.012.099	68
Trailer connecting cables for 2 cameras			
2x MEKRA - ABS 7-pin (m-m) 0.5 m	917502	917502	69
ABS 7-pin - 2x MEKRA (m-f) 0.5 m	971502	971502	69
ABS spiral cable 7-pin shielded (f-f), 3 m	977203	977203	69
ABS 7-pin - 2x MEKRA (f-f) 3 m	971203	971203	69

Camera monitor system accessories

Description	MEKRAtronic	MEKRA Lang	P.
Accessories for connections			
ABS parking socket	900003	08.5610.110	70
Repair cables			
MEKRA (m) - open end 0.5 m	900050	09.5610.050	70
MEKRA (f) - open end 0.5 m	900051	09.5610.051	70
Adapter cables			
MiniDIN - AMP (m-m) 0.5 m	932001	932001	70
Adapter cables for 3rd party camera systems			
MiniDIN HD - MEKRA (m-f) 0.5 m	900032	09.1301.124.099	71
Binder - MEKRA, fixed mirroring (m-f), 0.5 m	900041	09.1301.069.099	71
Digitales Funksystem			
Wireless receiver	–	23.1305.004.099	72
Wireless transmitter	–	23.1305.005.099	72

Active alarm systems

Turn Assist System AAS 1312 and accessories

Description	MEKRAtronic	MEKRA Lang	P.
Kits			
Turn Assist System AAS 1312, GPS version (LHD)	822020	61.1312.002.099	74
Turn Assist System AAS 1312, CAN version (LHD)	822030	61.1312.001.099	74
Radar sensor mounting brackets			
Radar sensor mounting bracket, adjustable	820170	820170	75
Radar sensor mounting bracket, rigid	820190	820190	75
Extension cables			
Chassis extension cable	811076	09.1312.005.099	75
Driver's cab extension cable	811005	09.1312.004.099	75
Spare parts			
Sensor 3.4m, AAS (LHD)	822101	08.1312.001.099	74
GPS antenna	820019	23.1312.001.099	74
GPS display (G2000) (LHD)	820020	24.1312.001.099	74
CAN display (D2002) (LHD)	820030	24.1312.002.099	74
SD cable kit 7.6 m, AAS	811074	09.1312.001.099	74
SD cable kit 1m / RCA 3m	811003	09.1312.002.099	74

Turn Assist System AAS 1314 and accessories

Description	MEKRAtronic	MEKRA Lang	P.
Kits			
Turn Assist System AAS 1314	842008	61.1314.001.099	76
Zubehör			
Cover sensor	852100	12.1314.001.099	76
Extension cord 3 m	820190	09.1314.002.099	76
Ersatzteile			
Sensor		08.1314.001.099	76
Display		24.1314.001.099	76
IMU		23.1314.001.099	76
Cable kit	850008	09.1314.001.099	76
Bracket IMU		11.1314.002.099	76
Bracket Display		11.1314.001.099	76

OE Numbers – MEKRA Cross-reference-table

Cross-reference-tables

ALBACH

OE-Number	MEKRA Lang	P.
3010080890	08.5611.400	-
3010080900	28.1301.001.099 +	38
	11.1301.017.099	39
3010080910	09.5610.352	66
3010080920	09.5610.131	66
3010081400	09.5610.141	66
3010084580	28.1301.001.099	38
3010084590	11.1301.017.099	39
3010124690	24.1301.501.099	-
3010124700	28.1301.002.099	38
3010124710	28.1301.008.099	38
3010124720V	28.1301.004.099	38
3010125900	09.1301.005.099	66
3010125910V	09.1301.004.099	66
3010125920V	09.5610.111	66
3010126760	09.5610.360	66
3010127200	09.5610.050	70
3010127210	09.5610.051	70
3010163530	28.1301.053.099	-
3010293810	61.1301.002.099	-
3010316570	09.1301.067.099	-

BOSCH REXROTH

OE-Number	MEKRA Lang	P.
R902109630	28.1301.003.099	38
R902603837	28.1301.005.099	38

DOOSAN

OE-Number	MEKRA Lang	P.
527986	09.5610.111	66
537095	09.5610.051	70
537216	28.1301.050.099 +	-
	11.1301.017.099	39

HORSCH

OE-Number	MEKRA Lang	P.
00348000	09.1301.003.099	66
00496251	24.1301.002.099	-
00496252	61.1301.002.099	-
00496253	20.5610.400	47
04003820	09.1201.008.099	66/67
04003822	28.1301.004.099	38
04003823	28.1301.008.099	38
04003824	11.1200.502.099	39
04004454	09.1301.005.099	66
04004455	24.1301.501.099	-
04004689	09.5610.111	66
04105151	09.5610.111	66
60046314	09.5610.121	66

HSM

OE-Number	MEKRA Lang	P.
151493	09.5610.111	66
151494	09.5610.121	66
151491	09.5610.352	66
151492	09.5610.360	66
151495	11.1200.501.099	39
154368	23.1305.004.099 +	72
	23.1305.005.099	72
151486	24.1301.501.099	-
151485	24.1306.500.099	46
151490	28.1301.004.099	38
151488	28.1301.006.099	38

KOMATSU

OE-Number	MEKRA Lang	P.
79011673	11.1301.018.099	38
90795240	28.1301.007.099 +	38
	11.1301.017.099	39
90795740	09.5610.350	-
90796840	09.5610.141	66
90796940	09.5610.121	66
90797040	09.5610.111	66
94167440	08.1201.501.099	-
94167540	28.1301.039.099	40
95018140	28.1301.003.099 +	38
	11.1301.017.099	39
95045140	08.1201.501.099	-
99926140	28.1301.007.099	38
99983240	28.1301.050.099 +	-
	11.1301.017.099	39

LIEBHERR MISCHTECHNIK

OE-Number	MEKRA Lang	P.
11167012	28.1301.004.099	38
11167013	11.1200.502.099	39
11167014	09.5610.141	66
11167015	09.5610.111	66
11167016	09.5610.360	66
11167017	09.1301.062.001	51
11167019	09.5610.310	68
11167020	09.5610.320	68
11167021	09.5610.225	68
11167025	09.5610.121	66
11167026	09.5610.131	66
11167041	09.1201.012.099	68
11167572	09.6000.001.000	53
11167573	09.1301.107.099	49
11167574	08.5600.502.003	48/57
11167580	09.1301.108.099	55/58
11167581	09.1301.124.099	71
11167582	24.1306.500.099	46
11168102	09.5610.352	66
11169104	09.1301.140.001	51
12742357	09.1301.178.000	53
12744716	09.1307.020.099	51/57
12744822	09.5610.050	70
12744823	09.5610.051	70

LINDE / KION

OE-Number	MEKRA Lang	P.
3003504601	28.1301.003.099 +	38
	11.1301.017.099	39
9644718	61.1301.060.099	-
7919095614	28.1301.003.099	38

MAN

OE-Number	MEKRA Lang	P.	OE-Number	MEKRA Lang	P.	OE-Number	MEKRA Lang	P.
K3.25432-6000	09.5610.320	68	K3.28202-6005	09.1301.005.099 + 09.5610.310	66 68	ZD.28210-1640	09.1301.062.001	51
K3.25432-6001	09.5610.310	68	K3.28202-6006	09.5610.225	68	ZD.28210-1641	08.5600.504.003	51
K3.27609-6000	28.1307.002.099 + 09.1307.006.099 + 11.1307.027.099 + 24.1301.501.099	42 67 43 46	K3.28202-6007	09.5610.320 + 09.1307.010.099	68 67	ZD.28210-1642	08.5600.502.003	48/57
K3.27609-6001	28.1307.003.099 + 09.1307.006.099 + 11.1307.028.099 + 24.1301.501.099	42 67 43 46	K3.28202-6008	09.1301.062.001	51	ZD.28210-1644	28.1301.002.099	38
K3.27609-6002	28.1307.002.099 + 09.1307.006.099 + 09.1301.140.001 + 11.1307.027.099	42 67 51 43	K3.28202-6009	09.1301.140.001	51	ZD.28210-1645	28.1301.004.099	38
K3.27609-6003	28.1307.003.099 + 09.1307.006.099 + 09.1301.140.001 + 11.1307.028.099	42 67 51 43	K3.28202-6010	09.1307.003.000	52/59	ZD.28210-1646	09.1301.003.099	66
K3.27609-6004	28.1307.002.099 + 09.1307.006.099 + 09.1307.020.099 + 11.1307.027.099	42 67 51/57 43	K3.28202-6011	08.5600.502.003	48/57	ZD.28210-1647	09.1301.004.099	66
K3.27609-6005	28.1307.003.099 + 09.1307.006.099 + 09.1307.020.099 + 11.1307.028.099	42 67 51/57 43	K3.28202-6012	08.5600.504.003	51	ZD.28210-1648	09.1301.005.099	66
K3.28202-6000	09.1307.008.099	67	K3.28202-6013	08.5600.505.003	51	ZD.28210-1649	09.1301.006.099	66
K3.28202-6001	09.1307.007.099	67	K3.28202-6015	09.1307.020.099	51/57	ZD.28210-1650	09.1301.004.099 + 09.5610.310	66 68
K3.28202-6002	09.1307.006.099	67	K3.28202-6016	08.5600.506.099	51/57	ZD.28210-1651	09.5610.225	68
K3.28202-6003	09.1307.005.099	67	K3.28202-6017	09.1201.012.099	68	ZD.28210-1652	09.1307.010.099 + 09.5610.320	67 68
K3.28202-6004	09.1301.004.099 + 09.5610.310	66 68	K3.28202-6041	09.1307.023.099	51	ZD.28210-1653	09.1301.005.099 + 09.5610.310	66 68
			K3.28202-6042	09.1307.011.099	67	ZD.28210-1654	09.1201.012.099	68
			K3.28202-6043	09.1307.012.099	67	ZD.28210-1655	11.1301.017.099	39
			K3.28202-6044	09.1307.013.099	67	ZD.28210-1656	11.1200.502.099	39
			K3.28202-6045	09.1307.021.099	44	ZD.28210-1658	11.1301.018.099	38
			K3.28202-6046	09.1307.024.099	44	ZD.28210-1659	24.1301.501.099	46
			K3.28210-6000	24.1301.501.099	46	ZD.28210-1660	09.5610.310	68
			K3.28210-6002	28.1307.002.099	42	ZD.28210-1661	09.1301.140.001	51
			K3.28210-6003	28.1307.003.099	42	ZD.28210-1662	20.5640.101	39/41/ 43
			K3.28210-6004	28.1301.006.099	38	ZD.28210-1679	08.5600.505.003	51
			K3.28240-6000	11.1307.027.099	43	ZD.28210-1681	09.5610.111	66
			K3.28240-6001	11.1307.028.099	43	ZD.28210-1682	09.5610.121	66
			K3.28240-6013	61.1307.014.099	44	ZD.28210-1743	09.5610.051	70
			ZD.28210-0074	61.1312.001.099	74	ZD.28210-1922	09.1307.020.099	51/57
			ZD.28210-0076	24.1301.512.099	-			
			ZD.28210-0080	61.1312.002.099	74			
			ZD.28210-0086	28.1301.038.099	40			
			ZD.28210-0087	20.5620.601	41			

OE Numbers – MEKRA Cross-reference-table

Cross-reference-tables

MERCEDES-BENZ

OE-Number	MEKRA Lang	P.
A0008112510	11.1301.006.099	-
A0148209904	09.5610.360	66
A4058270004	09.1301.022.000	-
A4058270104	09.1301.003.099	66
A4058270904	09.6000.001.000	53
A4058271004	09.6000.002.000	-
A4258200097	28.1301.003.099 +	38
	11.1200.502.099	39
A4258200297	28.1301.003.099 +	38
	11.1301.017.099 +	39
	20.5640.101	39
A42582003.97	28.1301.007.099 +	38
	11.1301.017.099 +	39
	20.5640.101	39
A4258270104	09.5610.360	66
A4258270204	09.5610.121	66
A9568270004	09.1301.100.000	-
A9568270104	09.5610.360 +	66
	09.5610.111	66
A9568270204	09.1301.006.099	66
B6 782 1265	09.5610.310 +	68
	09.1201.012.099 +	68
	08.5610.110	70
B66848654	61.1312.001.099	74
B66848662	09.1312.002.099	77
B66848663	09.1312.001.099	77
B67530171	09.6000.001.000	53
B67821267	24.1301.512.099	-
B67821268	08.5600.501.002	54
B67821269	28.1301.176.099 +	38
	11.1301.017.099 +	39
	09.5610.360	66
B67821275	28.1301.001.099 +	38
	11.1301.017.099 +	39
	09.5610.360	66
B67821277	09.5610.111	66
B67821278	09.5610.121	66
B67821279	09.5610.131	66
B67821280	09.5610.141	66
B67821281	09.5610.310 +	68
	09.5610.320 +	68
	09.5610.225 +	68
	08.5610.110	70

OE-Number	MEKRA Lang	P.
B67821330	28.1301.003.099 +	38
	11.1301.017.099 +	39
	09.5610.360	66
B67821331	20.5640.101	39/41/ 43
B67821332	28.1301.002.099 +	38
	11.1301.017.099 +	39
	09.1301.178.000	53
B67821333	28.1301.004.099 +	38
	11.1301.017.099 +	39
	09.1301.178.000	53
B67821334	28.1301.175.099 +	38
	11.1301.017.099 +	39
	09.1301.178.000	53
B67821335	09.1301.179.000	54
28.1301.503.001	28.1301.003.099 +	38
	11.1200.502.099	39
28.1301.503.002	28.1301.003.099 +	38
	11.1200.502.099	39
28.1301.029.001	28.1301.003.099 +	38
	11.1301.017.099 +	39
	20.5640.101	39
28.1301.029.002	28.1301.003.099	38
	+11.1301.017.099	39
	+20.5640.101	39
28.1301.028.001	28.1301.007.099 +	38
	11.1301.017.099 +	39
	20.5640.101	39
28.1301.028.002	28.1301.007.099 +	38
	11.1301.017.099 +	39
	20.5640.101	39
09.1301.101.001	09.5610.360 +	66
	09.5610.111	66
28.1301.502.002	28.1301.176.099 +	38
	11.1301.017.099 +	39
	09.5610.360	66
28.1301.501.002	28.1301.001.099 +	38
	11.1301.017.099 +	39
	09.5610.360	66
09.5610.226	09.5610.310 +	68
	09.5610.320 +	68
	09.5610.225 +	68
	08.5610.110	70

OE-Number	MEKRA Lang	P.
28.1301.512.002	28.1301.003.099 +	38
	11.1301.017.099 +	39
	09.5610.360	66
28.1301.513.002	28.1301.002.099 +	38
	11.1301.017.099 +	39
	09.1301.178.000	53
28.1301.514.002	28.1301.004.099 +	38
	11.1301.017.099 +	39
	09.1301.178.000	53
28.1301.515.002	28.1301.175.099 +	38
	11.1301.017.099 +	39
	09.1301.178.000	53

PONSSE

OE-Number	MEKRA Lang	P.
0076260	28.1301.003.099	38
0076261	28.1301.001.099	38
0076262	11.1200.502.099	39
0076264	09.1301.003.099	66
0076265	09.5610.121	66
0076659	11.1200.501.099	39
0076886	28.1301.007.099	38
0077635	24.1301.512.099	-
0077982	09.1301.124.099	71
0080494	09.5610.111	66
0082771	61.1301.002.099	-
0083051	20.5610.400	47
0084773	24.1301.501.099	46

TRIOLIET

OE-Number	MEKRA Lang	P.
96120	08.5611.400	-
96121	28.1301.001.099	38
96122	11.1301.017.099	39
96123	09.1201.006.099	66/67
96136	09.5610.121	66
96489	20.5610.400	47
96571	09.1201.009.099	66/67
9800065	09.1201.007.099	66/67
9800767	28.1301.176.099	38

Notes

Room for Ideas

A large grid of graph paper for taking notes. The grid consists of 30 columns and 30 rows of small squares, providing a structured space for writing and drawing.

Funding Programs

Turn Assist System / De-minimis and BG BAU

Turn Assist System

The German government provides financial funding for the purchase and installation of turn assist systems which have been granted a National Type Approval (Allgemeine Betriebserlaubnis, ABE) by Germany's Federal Motor Transport Authority (Krafftahrt-bundesamt, KBA). The goal is to reduce risks for vulnerable road users, such as pedestrians and cyclists, and protect them from serious accidents.

Commercial vehicles with a maximum authorized mass of more than 3.5 metric tons and buses with more than nine seats are eligible for governmental assistance under this scheme. The funding is provided for vehicles operated in Germany and used for commercial as well as freelance, non-profit, and public purposes. This comprehensive funding will be available until the installation of these systems is required by law or until the end of 2024 at the latest.



De-minimis

As part of the "De-minimis" program, the German government supports supplementary measures that are designed to increase safety. This includes but is not limited to the installation of camera systems, radar systems and telematics systems. Road freight transport companies operating heavy-duty commercial vehicles are eligible to receive federal funding, however, there is no entitlement to receiving De-minimis funding.

Eligible installations include but are not limited to: rear view cameras, rear view video systems, blind spot alert systems (unless they are turn assist systems as defined by the relevant recommendations of the German Federal Ministry for Digital and Transport, BMVI), and front view cameras.

The list of eligible products by funding period is available on the German Federal

Freight Agency's (Bundesamt für Güterverkehr) website.

Source: Bundesamt für Güterverkehr (Federal Freight Traffic Agency)



BG BAU – German Employer's Liability Insurance Association for the Construction Industry

BG Bau grants various occupational safety premiums for retrofitting turn assist systems (AAS), rear view cameras (for construction machinery and trucks) and side view cameras (for backhoes and trucks).

Detailed information:

Rear view camera for backhoe and truck applications:



Side view camera for backhoe and truck applications:



Aftermarket Locations

Contact and service



MEKRA Lang GmbH & Co. KG

Buchheimer Str. 4
91465 Ergersheim
Germany
Hotline +49 9847 989 8757
Telefon +49 9847 989-0
bestellungen@mekra.de
www.mekra.de



MEKRA Lang International ČR. spol. s.r.o

Družstevní 185
33008 Zruč
Czech Republic
Telefon +42 0 377 824-893
Fax +42 0 377 824-893
mekra@mekra.cz
www.mekra.cz



MEKRA UK Limited

17 Willowbrook Road
Ham Bridge Trading
Estate BN14 8NA
Worthing,
Great Britain
Telefon +44 1903 206106
Fax +44 1903 214395
info@mekra.co.uk



MEKRA FRANCE

Bâtiment G
Avenue des Frères Lumière 26 - 32
78190 Trappes
France
Telefon +33 30 47 43 85
Fax +33 30 47 45 16
info@mekra.fr
www.mekra.fr



DIN EN ISO 9001: 2008

ISO TS 16949: 2002

DIN EN ISO 14001: 2004

General Terms and Conditions

Last Update: 06/2024

I. General Provisions

The contractual relationship between us, MEKRA Lang GmbH & Co. KG ("MEKRA Lang"), and our ordering parties ("Purchasers"), who are entrepreneurs as defined in § 14 BGB (German Civil Code), is solely governed by the General Terms and Conditions of Sale and Delivery (AGB) set out below. Dissenting terms and conditions of the Purchaser, even if known to us, shall not form part of the contract. Our offers shall be non-binding at all times. Our General Terms and Conditions of Sale and Delivery shall be regarded as accepted upon order placement, at the latest upon acceptance of the goods. In the case of an on-going business relationship, these General Terms and Conditions of Sale and Delivery shall also apply to all subsequent transactions. The invalidity of any provision of these general terms and conditions, in whole or in part, shall not affect the validity of the remaining provisions. In this case, MEKRA Lang and the Purchaser shall agree on provisions that shall be suitable to implement the economic purpose of the invalid provisions to the greatest extent possible. Until such time, the relevant legal provisions shall apply.

II. Contract Conclusion and Prices

1. By ordering goods the Purchaser bindingly states the wish to purchase the goods ordered. This statement shall remain binding for a period of two weeks. We shall be entitled to accept the submitted contract offer within a period of two weeks after receipt thereof. Acceptance may be declared in writing, electronically, or by delivery of the goods to the Purchaser.
2. The obligations pertaining to electronic commerce set forth in § 312e Sec. 1 sentence 1 Nos. 1 to 3 and sentence 2 BGB shall be excluded.
3. The conclusion of the contract shall be subject to orderly and timely receipt of goods from our own suppliers. This shall apply only, if we cannot be held responsible for the non-delivery, especially if we have entered into a congruent coverage transaction with our own suppliers. The Purchaser shall be informed of the non-availability of the goods or services without delay, and any compensation that has already been paid shall be reimbursed immediately.
4. All payments to be made hereunder shall be made in Euros.
5. All prices quoted shall be net ex works or distribution warehouse, respectively. Freight, packaging and import costs, as well as customs duties and other ancillary expenses shall be payable by the Purchaser.

III. Delivery Time and Delivery Obligation

1. Extent, type, and time of delivery shall be subject to our written or electronic order confirmation. Partial deliveries shall be permissible.
2. Any obligation to comply with delivery deadlines deemed as binding shall be conditional on the undisturbed flow of operations and distribution processes; particularly in cases of force majeure and other disruptive events at our facilities or those of our suppliers or carriers, including but not limited to operational or traffic disruptions, fire, flooding, labor, energy, or traffic shortages, strikes, lockouts, acts of public authorities as well as technical or technological conditions that considerably impede the execution of the contract, shall release us from the obligation to deliver on time or entitle us to suspend delivery without any obligation for subsequent delivery.
3. Unless otherwise agreed, we shall be entitled to deliver before a stated delivery date. Additionally, unless otherwise agreed, any delivery of up to two weeks past a stated delivery date shall not be regarded as delayed on our end.
4. When the goods have left the factory or distribution warehouse or the Purchaser has received notice of our readiness to deliver by the time the delivery dates expire, said delivery dates shall be regarded as met. Subsequent contract amendments shall provide for reasonable delivery date extensions.
5. Where the performance of a contract consists of multiple deliveries, the non-fulfillment, improper fulfillment or delayed fulfillment of one delivery shall not affect the other deliveries

pertaining to the contract.

6. Defaults in payment, declarations in lieu of an oath as per § 807 ZPO (German Code of Civil Procedure), emergent payment difficulties or signs of significant deterioration in the Purchaser's financial position shall entitle us, at our discretion, to demand advance payment for deliveries not yet completed, or to call off deliveries immediately and to refuse the fulfillment of current contracts. At the same time, we shall be entitled to make due and payable with immediate effect any accounts receivable from the Purchaser which are not due yet.

IV. Shipping, Transfer of Risk

1. Unless otherwise agreed by the contracting parties, packaging, shipping route and method of transportation remain at our discretion.
2. Upon hand-over, or in case of a sale by dispatch upon delivery of the goods to the forwarding agent, the carrier, or any other person or institution designated to execute the shipment, the risk of accidental loss and accidental deterioration of the goods shall be passed on to the Purchaser. If the Purchaser defaults on acceptance, this shall be deemed equivalent to hand-over.
3. Unless otherwise agreed, goods from call orders shall be accepted within 3 months upon order confirmation.
4. Insurance coverage for breakage and transportation risks shall be taken out upon special request only, and for a corresponding fee.
5. Customs duties and other expenses, including those for obtaining the required import documents for the country of destination, shall be payable by the Purchaser.

V. Payment, Payment Terms

1. Invoices shall be payable:
 - a) within 14 days from the date of invoice including a 2 % cash discount on the final invoice value;
 - b) within 30 days from the date of invoice without a cash discount on the final invoice value.
2. A cash discount shall be granted only, if all payment obligations arising from earlier deliveries have been fulfilled and the invoice amount has been submitted to us in cash or credited to our account in a timely fashion by the aforementioned due dates. As a result, the submission of a bill of exchange cannot lead to the granting of a cash discount. In case of a cashless payment, especially when a check is submitted, the time the amount is credited shall be the determining factor. A cash discount cannot be granted for amounts that are paid or credited conditionally or subject to other limitations. The Purchaser shall assume any and all risks in connection with the method of payment. Invoices for tools shall be payable immediately without cash discount.
3. Bills of exchange and cheques shall be accepted on account of performance only. The corresponding amounts shall be credited subject to receipt of the full amount due. We reserve the right to accept other or own acceptances. Expenses and discount charges shall be payable by the Purchaser. We shall assume no responsibility for submission and protest. If the Purchaser's own bills of exchange have been protested or if protested other bills of exchange not have not been covered immediately, we shall be entitled to return any and all pending bills of exchange. At the same time we shall be entitled to make immediately due and payable those accounts receivable from the Purchaser which are not due yet. Pre-dated checks shall not be accepted.
4. In case of missed payment dates, interest on defaulted payment of 9 % above the base rate of the German Central Bank according to § 247 BGB shall be payable, as well as damages due to late performance in the amount of € 40.00 according to § 288 Sec. 5 BGB. We shall continue to reserve the right of assertion of further damages due to late performance and other claims.
5. Advance and interim payments shall be non-interest bearing.
6. The Purchaser shall be entitled to offset or withhold payment only if the counterclaim is undisputed or has been determined

legally binding. The Purchaser may execute a right of retention only if his counter claim is based on the same contractual relationship.

7. When settling invoices, the Purchaser shall provide the respective customer and invoice numbers. Any costs due to delays or accounting errors resulting from a failure to do so, shall be borne by the Purchaser.

VI. Retention of Title, Factoring

1. We shall retain full title to the goods that have been delivered, until such time as any and all receivables arising from the business relationship with the Purchaser have been paid. The Purchaser shall be entitled to resell the goods to which we have retained title within the ordinary course of business; however, any pledging or security transfer shall not be permissible. Where the goods to which we have retained title are being resold on credit, the Purchaser must ensure that our rights are protected.
2. The Purchaser hereby assigns to us any of the Purchaser's receivables arising from the resale of the goods to which we have retained title in the amount invoiced; we hereby accept such assignment. Regardless of the assignment, the Purchaser shall retain the right to collect payment, provided that he fulfills his obligations owed to us according to the underlying contractual relationship and does not fall into financial decline. Otherwise the Purchaser shall, upon our request, provide any information about the assigned receivables that are required for collection, and shall notify his debtors of the assignment. In this case we shall reserve the right to collect the receivables on our own.
3. Any finishing or processing of the goods to which we have retained title by the Purchaser shall be performed on our behalf and by our order, however, without resulting in any obligations for us. If the goods to which we have retained title are processed with goods that are third-party property, then we shall acquire co-title to the new goods. The proportion of co-title shall follow from the proportion of the value of the goods to which we have retained title and the value of the other processed goods. Any references herein to the value of the goods to which we have retained title shall be based on our invoice value.
4. Should the Purchaser acquire sole ownership of the new goods according to § 947 Sec. 2 BGB, it is agreed that the Purchaser shall grant us co-title to the new goods in proportion of the value of the processed, combined, or mixed goods to which we have retained title, and shall remain custodian of the goods which shall be free of charge.
5. Where the goods to which we have retained title are resold together with other goods, regardless of whether or not they were processed, combined or mixed, the advance assignment agreed to above is valid only to the extent of the value of the goods to which we have retained title that were resold together with the other goods. If requested, we shall release the securities we are entitled to as provided above, insofar as the value exceeds the claims to be secured by 20 %.
6. The Purchaser shall immediately notify us of any third-party compulsory execution measures regarding the goods to which we have retained title or the receivables assigned in advance and shall provide us with any documents required for an intervention. Any related intervention costs shall be payable by the Purchaser.
7. The Purchaser shall take out adequate fire and burglary insurance for the goods to which we have retained title and shall provide us with corresponding proof, if requested.

VII. Warranty Claims

1. The period of limitation for warranty claims is 24 months from the delivery of the goods.
2. Initially, we shall remedy any defects in the products through either reworking or replacement (at our discretion). Where defects cannot be remedied through reworking or replacement, the Purchaser shall have the right to demand a cancellation of the contract or a reduction in compensation. However, the

Purchaser shall not be entitled to cancel, if the lack of conformity is minor, and particularly if the defects are minor.

3. The Purchaser must notify us in writing of any obvious defects without delay, at the latest within 7 days after receipt of the goods, suspending any processing immediately. Otherwise the assertion of any warranty claims shall be excluded. The timely dispatch of the notification shall be deemed sufficient for compliance with the notification period. The full burden of proof regarding all requirements for asserting claims shall be borne by the Purchaser, especially for the defect itself, for the time of the establishment of the defect, and for the timeliness of the complaint regarding the defect.
4. Defects which, despite careful inspection, cannot be ascertained within this time period are to be reported to us in writing immediately upon discovery. If, after a failed cure, the Purchaser opts for a withdrawal from the contract due to a legal or material defect, the Purchaser shall not also be entitled to seek damages based on the defect.
5. If, after a failed cure, the Purchaser opts for damages, the goods shall remain with the Purchaser, if this can be reasonably expected. Damages are limited to the difference between the purchase price and the value of the defective product. This shall not apply if we caused the contract violation maliciously.
6. Title to all goods for which we provided replacement, will pass to us and such goods shall be returned to us for a reimbursement of costs.
7. No claims may be asserted for damages which were negligently caused by the Purchaser through
 - a) improper handling or excessive use of the purchased item, or
 - b) unauthorized modification of the purchased item, or
 - c) non-compliance with the assembly or operating instructions, or
 - d) a breach of the complaint and delivery obligations according to para. 3 and 4 above, or
 - e) continued use of the purchased item after the defect has been ascertained. Ordinary wear and tear shall be excepted from the warranty.

VIII. Liability

1. In case of slightly negligent breaches of duty, our liability shall be limited to the average immediate damage that can be reasonably and typically expected for the respective contract type. The aforementioned shall also apply to slightly negligent breaches of duty by our legal representatives or agents. We shall not be held liable in case of a slightly negligent breach of nonessential contract obligations.
2. Any liability based on assumed warranties as well as product liability shall remain unaffected, including for bodily harm or health impairments attributable to us or loss of life of the Purchaser.
3. The period during which the Purchaser shall be entitled to claims for damages due to a defect is limited to one year from delivery of the goods. The aforementioned shall not apply, if we can be accused of willful intent or gross negligence, as well as bodily harm or health impairments attributable to us or loss of life of the Purchaser.
4. Notice Regarding Market Surveillance: As a distributor and importer, you play an important part in ensuring the compliance and safety of products in the market. As a distributor and importer of our products, you are required to comply with the applicable legal provisions and obligations regarding market surveillance, should there be any indications of discrepancies (e.g. in the form of complaints regarding non-compliance with ECE R46 or general, safety-related issues). Please adhere to the corresponding reporting requirements in connection with the above-mentioned anomalies. Any reports to us should be comprised of transparent and verifiable information. Please contact your sales team representative.

IX. Returns

As a rule, returns of goods that were properly ordered and delivered shall not be accepted. Returns that have been arranged with us shall be the exception. In addition, the following prerequisites must be met:

1. The products must have been purchased directly from us or from one of our factory warehouses.
2. The goods must be in flawless and unaltered condition.
3. As a rule, we shall accept returned goods or parts only if they are still part of our current product portfolio.
4. Returns must be shipped „free domicile“ to our plant in Ergersheim or to the appropriate factory warehouse and must include the respective delivery note dates and numbers. Value reduction for returns:
 - in the 1st year after delivery date ./ 10 % of the contract price
 - in the 2nd year after delivery date ./ 25 % of the contract price
 - between the 3rd and the 5th year after delivery date ./ 50 % of the contract price
 - Any goods older than 5 years may not be returned.Upon receipt of the parts, a technical inspection shall be performed and a credit slip completed, taking into account any applicable value reductions. The remaining value shall be reduced by any original shipping costs incurred by us.

X. Intellectual Property Rights

1. Regarding custom-made products, the Purchaser shall be liable to us for the exemption from third-party intellectual property rights in connection with the items ordered, shall indemnify us against any possible third-party claims and shall compensate us for any damages resulting from a breach of this obligation.
2. Our designs and design proposals shall be kept confidential and may not be passed on to third parties.
3. Any drawings, construction plans, and samples provided to the Purchaser shall remain our intellectual property.

XI. Place of Fulfillment, Jurisdiction, Other Agreements

1. As a rule, it shall be considered agreed that the condition of the goods is solely set forth in our product description. Any public statements, sales talks, or advertisements by us shall not represent a contractual description of the condition of the goods. Samples and specimens shall serve as approximate illustrative articles regarding product quality, dimensions and color and cannot serve as the basis for asserting any legal claims. We reserve the right to make reasonable technical changes as well as modifications in shape, color, and/or weight.
2. If the Purchaser receives inaccurate assembly instructions, we shall only be obliged to provide accurate assembly instructions, and only, if the inaccurate assembly instructions prevent proper assembly.
3. We shall not grant any warranties in the legal sense to the Purchaser; the aforementioned shall not affect any manufacturer's warranties.
4. The place of fulfillment for our deliveries ex works shall be the delivery plant; the place of fulfillment for our deliveries ex stock shall be the warehouse. The place of fulfillment for any payments shall be Ergersheim in Bavaria, Germany.
5. The exclusive place of jurisdiction for any disputes regarding this contract shall be Fürth in Bavaria, Germany. This shall also apply to lawsuits regarding checks or bills of exchange.
6. The law of the Federal Republic of Germany shall govern these provisions. The provisions of the UN United Nations Convention on Contracts for the International Sale of Goods shall not apply. The German-language version of these General Terms and Conditions of Sale and Delivery shall apply exclusively.
7. The special terms of our products published with the appropriate price lists shall apply as well.
8. The Purchaser shall be responsible for examining the suitability of the goods for their intended use.
9. In accordance with the provisions of the German Federal Data Protection Law (BDSG), we wish to note that all Purchaser data required for order processing will be stored electronically.

MEKRA Lang - **passion** for excellence.

Contents are subject to change.

Last Update: October 2023

www.mekra.de

